

TEXAS

Date: 1 June 1981

No. P2-81-2B

Object: Bones and teeth

Material: Bone

Square: w. ext. N-S
Trench, Bat 12 K-1
South 1/2
Level:

Photograph:

Drawing:

Dimensions: L.,

H.,

W.,

Th.,

Technique:

Condition:

Description:

- Bos taurus: 4 Right tibia - proximal end
 5 Left ulna - "
 3 Left astragalus
 1 Left tibial epiphysis - large juvenile.
 11 (Right) acetabulum frag
 14 " "
 18 Right humerus - distal portion
 30? Upper molar (small)

- Cervus elaphus 6 Right scapula - articulation.
 9 Metatarsus - shaft frag
 7 Right humerus - distal end.

Equus (asinus) 2 (anterior) 3rd phalanx

Bos (brachycerus) 21 Metacarpus - shaft frag.

Medium large unid 10 Left tibia shaft frag. Ground
 17 " "
 8 Right humerus shaft frag.
 24 " "

Small unid 31-34 ribs - juvenile
 35 Radius proximal end

Large unid 23 Pelvis frag
 12 Long bone frag.

Unid 15 Scapula
 23 "
 20 "
 28 Epiphysis frag

12 unid - frags

TEXAS

Date: 1, June 1981

No. PZ -81-35

Object: chert

Material: stone

Square:

K¹-1
center square

Photograph:

Level:

Batt 12.

Drawing:

Dimensions: L.,

3.2cm.

H.,

W.,

2.2cm.

Th.,

0.9cm.

Technique:

at greatest points

Condition:

Description:

(from PZ-81-1PL)

Slightly eroded dark brown chert. Maybe
man made - several tiny
chips seem to have been
removed on 2 edges; larger chips
removed on another.

TEXAS

Date: 1, June 1981

No. 72 - 81 - 4M

Object: Slag

Material: Mold Slag.

Square: K¹-1 Batt. 12

Photograph:

Level:

Drawing:

Dimensions: L., 3.9cm H., W., 3.3 Th., 1.5

Technique: (Greatest Dimension)

Condition: Crumbly and encrusted

Description: (From 72-81-1PL)

Dark Red - Brown and Orange metallic
blobs within a light gray and yellow matrix

TEXAS

Date: 1 June 1981

No. PZ-81-5 WS

Object: Water Separation Samples

Material: Varied

Square: K1-1
Batt. 12

Photograph:

Level:

Drawing:

Dimensions: L.,

H.,

W.,

Th.,

Technique:

Condition:

Description: Products from Water Separation of
Soil Sample from area above. Done by BCC.

TEXAS

Date: 1 June 1981

No. PE -81 -6 WS

Object: Water Sep. Sample

Material: Varied

Square: K1 - 1

Photograph:

Level: Batt. 12

Drawing:

Dimensions: L.,

H.,

W.,

Th.,

Technique:

Condition:

Description:

TEXAS

Date: 1 June 1981

No. P2 -81- 7WS

Object: Water Sep. Sample

Material: Varied

Square: K'-1 Bath
Brown Sand

Photograph:

Level:

Drawing:

Dimensions: L.,

H.,

W.,

Th.,

Technique:

Condition:

Description:

TEXAS

Date: 2 June 1981

No. PZ-81-8P

Object: Moulded Gray Ware Lamp Frag. Material: Pottery

Square: K1-1 Batt 12

Photograph:

W. Side. Oblique

Level: Brown Sand

Drawing:

Dimensions: L., 2.9cm. H., W., 1.0cm. Th., 2.6cm.

Technique: (Greatest Dimensions)

Condition: Slightly worn and encrusted

Description: On the part that would be the outer edge of the lamp, the material is pock-marked. There is a petal design on the lamp frag., with an indented line around the edge of the petals.

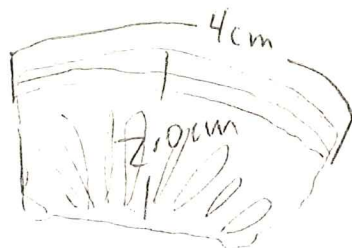

TEXAS

Date: 2 June 1981

No. PZ -81-9B

Object: Assorted Bones

Material: Bones

Square: K1-1 Bott. 12
W. Side

Photograph:

Level:

Drawing:

Dimensions: L.,

H.,

W.,

Th.,

Technique:

Condition:

Description:

TEXAS

Date: 2 June 1981

No. PZ-81-10M

Object: Slag.

Material: Metal Slag

Square: K1-1 Batt'd
w. side

Photograph:

Level: Olive Brown
Sand.

Drawing:

Dimensions: L.,

H.,

W.,

Th.,

Technique:

Condition: Crumbly

Description: 2 large lumps and a few small lumps.
Dark brown slabs in a matrix of orange, yellow
and grey crumbly material.

TEXAS

Date: 2 June 1981

No. PZ-81 - 12 WS

Object: Water Sep. Samples

Material: Varied

Square: K1-1 Ball. 2
N.W. Portion

Photograph:

Level: Olive Brown Sand

Drawing:

Dimensions: L.,

H.,

W.,

Th.,

Technique:

Condition:

Description:

TEXAS

Date: 2 June 1981

No. PZ-81-1365

Object: Water Sep. Samples

Material: Varied

Square: K1-1 Ball. 2
W. Wall

Photograph:

Level:

Drawing:

Dimensions: L.,

H.,

W.,

Th.,

Technique:

Condition:

Description:

TEXAS

Date: 2 June 1981

No. PZ -81-14 WS

Object: Water Sep. Samples

Material: Varied

Square: K-1 Balt. D

Photograph:

N. of Ctr. Dress
Level: Stone

Drawing:

Dimensions: L.,

H.,

W.,

Th.,

Technique:

Condition:

Description:

TEXAS

Date: 7 June 1981

No. PZ - 81-16 B

Object: 1 Frag.

Material: Box

Square: K-1 Batt. 12
E. Side Brown

Photograph:

Level:

Drawing:

Dimensions: L.,

H.,

W.,

Th.,

Technique:

Condition: Fragmentary

Description: (from PZ-81-15PL)

TEXAS

Date: 2 June 1981

No. PZ - 81 - 17 M

Object: Slag Chunks

Material: Metal

Square: K1-1 Batt. 12

Photograph:

E. Side, Brown

Level:

Drawing:

Dimensions: L.,

H.,

W.,

Th.,

Technique:

Condition: Crumbly

Description: (from PZ-81-15PK) Reddish-brown metal blobs in gray and orange matrix. 2 large chunks, several small ones.

TEXAS

Date: 2 June 1981

No. PZ-81-18P

Object: One Body Sherd Red figure Material: Pottery

Square: J'-1 Batt. 12
S. side Yellow

Photograph:

Level: Sand w/ fine gravel

Drawing:

Dimensions: L., 9.0cm. H., W., 7.8cm. Th., 1.0cm.
(greatest dimensions)

Technique:

Condition: Slightly scratched + chipped. Back is encrusted

Description: Red Palmette design.

. Black slip is not evenly applied.
Red bands on one side. Slight wheel ridging
on inside. Inside not decorated or painted.

Munsell 2.5YR 5/6 (light red).

TEXAS

Date: 2 June 1981

No. PZ -81-19WS

Object: Water Sep. Sample

Material: Varied

Square: 5' - 1 Batt. &

Photograph:

S.E.

Level:

Drawing:

Dimensions: L.,

H.,

W.,

Th.,

Technique:

Condition:

Description:

TEXAS

Date: 2 June 1981

No. PZ-81-21M

Object: Slag ~ 2 chunks

Material: Metal

Square: J-1 Butt 12
SW Corner interface

Photograph:

Level: Olive Brown

Drawing:

Dimensions: L.,

H.,

W.,

Th.,

Technique:

Condition: Crumbly and corroded

Description:

TEXAS

Date: 2 June 81

No. PZ-81 - 22B

Object: 2 Bone frags

Material: Bone

Square: J' - 1 Bell. 2

Photograph:

SW Corner

Level: Olive Brown Sand Drawing:

Dimensions: L.,

H.,

W.,

Th.,

Technique:

Condition:

Description:

TEXAS

Date: 2 June 1981

No. PZ 81-2305

Object: Water Sep. Sample

Material: Varied

Square: J'-1 Batt 12
SW corner

Photograph:

Level:

Drawing:

Dimensions: L.,

H.,

W.,

Th.,

Technique:

Condition:

Description:

TEXAS

Date: 2 June 1981

No. PZ-81-2405

Object: Water Sep. Sample

Material: Varied

Square: J'-1 Bath 12

Photograph:

S.W. quad.

Level: Yellow Sand

Drawing:

Dimensions: L.,

H.,

W.,

Th.,

Technique:

Condition:

Description:

TEXAS

Date: 2 June 1981

No. PZ-81-26P-A

Object: Portion (circumference) of Jug. ^{decorated} COURSE WARE Material: Pottery

Square: J-1 Batt 2

Photograph:

Level: Yellow to Gray

Drawing:

Dimensions: L., ^{max. preserved} H. 13.5 cm W., Th.,

Technique: Diameter at intersection of belly + neck 6.8 cm.

Condition: Fragmentary

Description: (from PZ-81-25PK) 4 body sherds forming circumference of a medium-sized jug. It is very round in the belly. The portion we have is below the neck and above the widest part of the belly of the jar. Both handle stamps are present.

Munsell 5YR 6/8 Reddish yellow, w/ darker red band decoration. Just under the handle stamps there is one [^] painted band around the jug. Another band goes around 3 cm. below it, and in between [^] there are wide diagonal brush strokes, or finger painted marks.

Munsell: interior: 2.5YR 6/8 (light red).
also took 8 sherds from PZ-81-35PK to keep in anticipation of joins

After gluing. One large fragment comprising 3 fragments does not join to main portion of jug comprising 13 fragments.

Max preserved ht. - 17 cm.

lowest diameter of belly - 24.5 cm. closing to 6.5 when neck would be.

There are 21.1 cm frags, no handles, no base frags present.

2 fragments from PZ-81-25PK

TEXAS

Date: 2 June 1981

No. PZ-81-26P-B

Object: Section of large jar ^{CERRILLO WARE} Material: Pottery

Square: f1-1 Bath to Photograph:

Level: Yellow to Gray Drawing:

Dimensions: L., H., c. 20cm. W., 19cm. Th., 1.1cm.

Technique: (Max. Preserved Dimensions)

Condition: Fragmentary

Description: (from PZ-81-25PL and PZ-81-35PL)

Section goes from neck base down to the place that was most likely the middle of the pot. This is a large jar, Undecorated.

Munsell 5YR 7/6 Reddish Yellow

^{16-VI-81}
1 fragment was dropped and is now in more pieces

TEXAS

Date: 2 June 1981

No. PE-81-28 B5

Object: Shell

Material: calcite or aragonite.

Square: 5'-1 Batt. 12

Photograph:

Yellow to Gray

Level:

Drawing:

Dimensions: L.,

H.,

W.,

Th.,

Technique:

Condition:

Description:

TEXAS

Date: 2 June 1981

No. PZ-81-30P

Object: Portion of a cookpot ^{of rim, handle & body} Material: Pottery

Square: J1-1 Batt 12.
on Gray (Part II).

Photograph:

Level:

Drawing:

Dimensions: L.,

H., 11.3 cm.

W.,

Th., 0.9 cm.

Technique:

(Max Preserved Dimensions)

Condition: Fragmentary + encrusted

Description: (from PZ-81-29PK). This portion of a wide-mouthed cooking vessel is comprised of 4 shreds. The handle lies against the rim of the vessel at the top. The material is sandy in texture with some small white inclusions. The rim flares out at about 45° and there are 2 distinct wheel ridges at the top of the neck. Munsell 10R 5.6 (red).

TEXAS

Date: 2 June 1981

No. PZ -81 -33 B

Object: 2 Bone Fragments

Material: Bone

Square: J-1 Batt. 12
In Gray

Photograph:

Level:

Drawing:

Dimensions: L.,

H.,

W.,

Th.,

Technique:

Condition:

Description:

TEXAS

Date: 2 June 1981

No. PZ-81-36 P.

Object: ^{RIM and Body} Portion of tableware jar - 13 sherds Material: Pottery

Square: 31-1 Batt 12
in tray

Photograph:

Level:

Drawing:

Dimensions: L.,

H., 2.2 cm
(near preserved)

W.,

Th., of body 0.7 cm
of rim 0.7 cm.

Technique:

Condition: Fragmentary - 6 pieces fit together, plus 6 sherds

Description: (From PZ-81-36 P)

Small Jar with large mouth and high neck. (Table amphora?) No handle stamps are present. Narrow incised double band decor. at neck and ^{3 cm. below.} Munsell 5YR 7/6 (Reddish Yellow).

After Restoration; 3 body sherds remain unjoined. 10 sherds are joined. Rim and body are preserved in part.

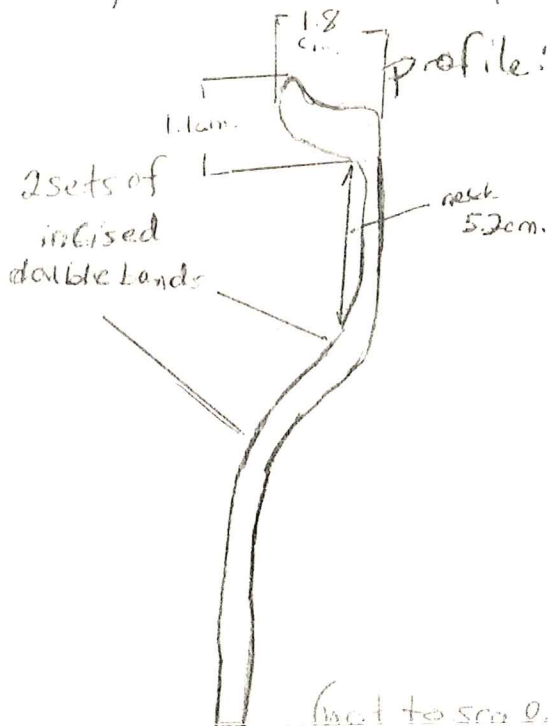

TEXAS

Date: 2 June 1981

No. PZ-81-37WS

Object: 2 charcoal lumps

Material: Charcoal

Square: J1-1 Bath-D

Photograph:

yellow-gray

Level: W. Side.

Drawing:

Dimensions: L.,

H.,

W.,

Th.,

Technique:

Condition: Clumpy + clay covered

Description: very small pieces

TEXAS

Date: 2 June 1981

No. PZ-81-38m

Object: Slag

Material: Metal

Square: J-1 Batt. 12
W. Side Yellow Sand
Level: w/ fine gravel

Photograph:

Drawing:

Dimensions: L.,

H.,

W.,

Th.,

Technique:

Condition: Clumpy and crumbly

Description: Rust colored inclusions in orange and gray matrix. 7 big clumps and several small ones, plus fine particles.

TEXAS

Date: 2 June

No. PZ-81. -39B

Object: Bone

Material: Bone

Square: J'-1 Datt. 12
W. Side
Yellow Sand w/ Fine
Level: Gravel

Photograph:

Drawing:

Dimensions: L.,

H.,

W.,

Th.,

Technique:

Condition:

Description:

TEXAS

Date: 2 June 1981

No. PZ-81-41P

Object: Fragmentary base of impressed gray ware bowl
Material: Pottery

Square: J¹-1 Batt. 12

Photograph:

(w side

Level: yellow w/ fine gravel
Drawing:

Dimensions: L.,

H.,

W.,

Th.,

Technique:

Condition: fragmentary

Description: (from PZ-81-40P2)

Small grayware plate or shallow bowl. Moulded design in bands and 3-leaf pattern.

thickness 0.4 cm

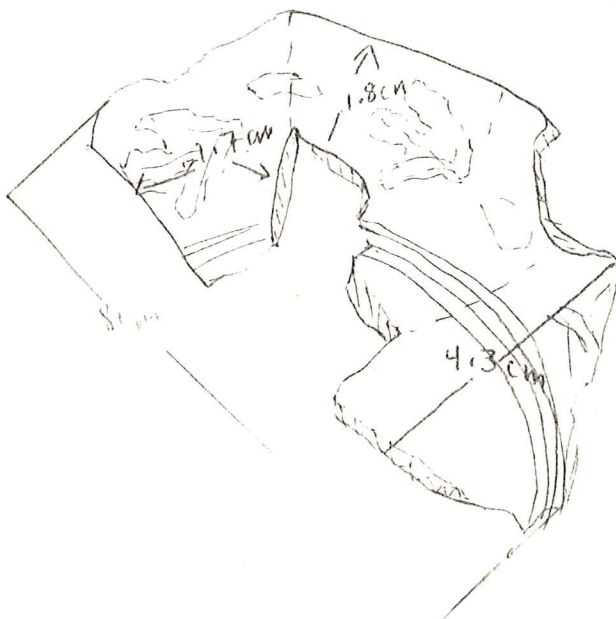

TEXAS

Date: 2 June 1981

No. PZ - 81 - 42TA+B

Object: 1/2 loom wts. One w/ stamp! Material: Tenacolla

Square: J-1 Batt 12

Photograph:

W. side
Level: Yellow w/ fine gravel

Drawing:

Dimensions: L.,

H.,

W.,

Technic:

A - Diameter 7.4cm.

A - 2.2cm

B - est. Diameter: 9.5cm.

B - 2.5cm

Condition:

A - good

B - Fragmentary

Description:

A - round loom weight, slightly encrusted

center: round stamp with figure of man or boy - flexing his arm? - figure is well worn.

B - portion of a round loom weight. One hole remains

Munsell: A: 5YR 6/6 (Reddish Yellow)

B: 2.5YR 6/8 (light red).

B:

TEXAS

Date: 2 June 1981

No. PZ-81 - 43-WS

Object: Wet Screen Sample

Material: Bones + Teeth

Square: J'-1 Batt. 12
w. side yellow

Photograph:

Level: Sand

Drawing:

Dimensions: L.,

H.,

W.,

Th.,

Technique:

Condition:

Description:

TEXAS

Date: 2 June 1981

No. PZ -81 -44 005

Object: Water Sep. Sample

Material: Varied

Square: J1-1 Batt 12

Photograph:

W. Side

Level: yellow soil
New Level

Drawing:

Dimensions: L.,

H.,

W.,

Th.,

Technique:

Condition:

Description:

TEXAS

Date: 2 June 1981

No. PZ-81-45 55

Object: Soil Sample

Material: Charcoal

Square: # 1-1 Bath 12

Photograph:

E. side

Level: Corner near sterile clay

Drawing:

Dimensions: L.,

H.,

W.,

Th.,

Technique:

Condition:

Description:

TEXAS

Date: 2 June 1981

No. PZ-81-47P

Object: Stamped Amphora Handle

Material: Pottery

Square: J-1 Batt 12

Photograph:

(tr.) Yellow to

Level: Gray Soil

Drawing:

Dimensions: L.,

H.,

W.,

Th. of handle

Technique:

2.1cm.
Max. preserved Th. of
vessel: 1.2cm.

Condition: Pot fragmentary.

Description:

Stamp reads DAMOKRATHS and is very
clear + legible.

(from PZ-81-46PL)

Munsell 5YR 7/6 (reddish yellow).

TEXAS

Date: 2 June 1981

No. PE-81-49P

Object: Gray Ware bowl section

Material: Pottery

Square: 51-1 Butt. 12
E. S. de Orig.

Photograph:

Level: level

Drawing:

Dimensions: L.,

H., max. Preserved
4.8 cm. W.,

Th., 0.6
max.

Technique:

Condition: Diameter of ring foot: 5.4 cm. Max. Preserved Diam. 13.2 cm.

Description: (from PE-81-48P)

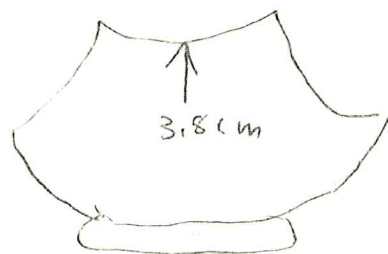
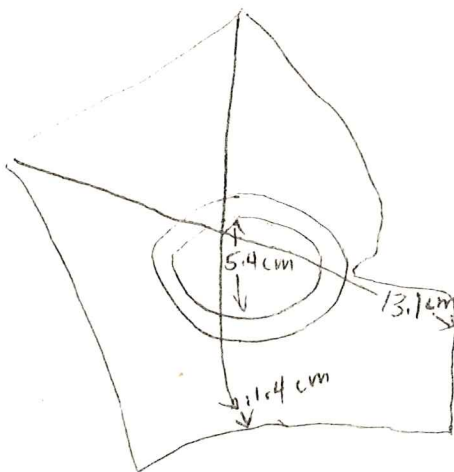

incomplete profile of gray ware bowl

thickness: 0.3 cm

TEXAS

Date: 2 June 1981

No. PZ-81 -> 50WS

Object: Water Sep. Sample

Material: Varied

Square: J'-1 Bath. 12

Photograph:

ctr. (olive brown sand)

Level: New level

Drawing:

Dimensions: L.,

H.,

W.,

Th.,

Technique:

Condition:

Description:

TEXAS

Date: 2 June 1981

No. PZ-81-51B

Object: Bone Frag.

Material: Bone

Square: J-1 Batt. D

Photograph:

E. Side Orig. level

Level: brown

Drawing:

Dimensions: L.,

H.,

W.,

Th.,

Technique:

Condition:

Description: 1 unidentifiable frag - discarded.

TEXAS

Date: 2 June 1981

No. PZ-81-52M

Object: Slag

Material: Metal Slag

Square: J¹-1 Batt. 12
E. Wing

Photograph:

Level:

Drawing:

Dimensions: L.,

H.,

W.,

Th.,

Technique:

Condition: Crumbly

Description:

TEXAS

Date: 2 June 1981

No. PZ-81-5355

Object: Charcoal

Material: Charcoal

Square: J1-1 Batt. R
E. side

Photograph:

Level:

Drawing:

Dimensions: L.,

H.,

W.,

Th.,

Technique:

Condition:

Description:

✓

TEXAS

Date: 2 June 1981

No. PE-81 54 55

Object: Charcoal

Material: Charcoal

Square: J1 - 1 Batt. R

Photograph:

Level: E. side
Brown Soil

Drawing:

Dimensions: L.,

H.,

W.,

Th.,

Technique:

Condition:

Description:

TEXAS

Date: 2 June 1981

No. PZ-81-55 T

Object: Loom Wt. - Round

Material: Tenacotta

Square: J'-1 Butt. 12
E. side Brown

Photograph:

Level: (orig. level)

Drawing:

Dimensions: L.,

H.,

W.,

Th., 2.2 cm.

Technique:

8.9 cm. max preserved Diameter

max. preserved

Condition: Encrusted and chipped

Description: Round loom Wt.

Munsell: 5YR 7/6 (reddish yellow)

TEXAS

Date: 2 June 81

No. PZ-81 - 57B

Object: Bone Frag

Material: Bone

Square: J-1 Ball. D

Photograph:

Yellow-Gray

Level: Q. Side

Drawing:

Dimensions: L.,

H.,

W.,

Th.,

Technique:

Condition:

Description:

TEXAS

Date: 2 June 1981

No. PZ - 81 - 58B

Object: Bone Frag

Material: Bone

Square: J-1 Batt. 12
E. Side

Photograph:

Level: Brown Soil

Drawing:

Dimensions: L., H., W., Th.

Technique:

Condition:

Description:

TEXAS

Date: 2 June 1981 No. PZ-81-59MA+B

Object: Chunk of Slag and a nail Material: Metal

Square: J1-1 Batt.
12 E. side
Level: Brown Sand

Photograph:

Drawing:

Dimensions: L., H., W., Th.

Technique:

Condition: Crumbly + Encrusted + Oxidized

Description: A - Chunk of slag
B - Nail - broken

TEXAS

Date: 2 June 1981

No. PZ-81-61PA+B

Object: 2 Gray Ware Fragments - Strainers Material: Pottery

Square: J1-1 Batt. 62

Photograph:

E. Side yellow

Level: Sand fine gravel

Drawing:

Dimensions A: H., 3.1 cm (max. preserved ht.)
inner diameter of neck 2.3 cm.

Th.,

Technique: B: 6.9 cm. max. preserved ht.

Condition: Fragmentary and encrusted

Description: A - Portion of neck of gray ware vessel - perhaps an oil strainer. Preserved strainer has 5 holes. Above strainer on neck there is a handle stump. Slip on outside is dark gray - darker than on B.

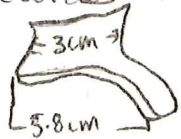

B - Strainer, neck and portion of rim of larger vessel than A. Four (4) holes are preserved. Lip is offset from inner edge of neck.

Rim is disc type with a flared edge on outside. Something like drawing below.

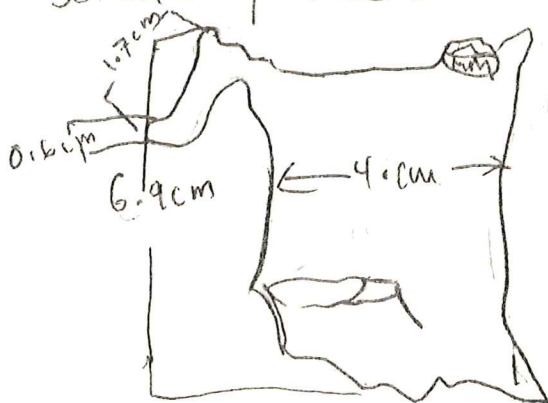

Drawing not to scale

TEXAS

Date: 2 June 1981

No. PZ-81-62P

Object: Gray Ware ^{Shallow} Bowl Base Material: Pottery

Square: J1-1 Batt. B

Photograph:

E. side yellow
Level: Sand fine gravel

Drawing:

Dimensions: L.,

H.,

W.,

Th.,

Technique:

Condition: Fragmentary

Description: (from PZ-81-60PL)
Shallow bowl base w/ lumps. This catalogue believes they (the lumps) are from air pockets in the clay. 2 slurs comprise the fragment

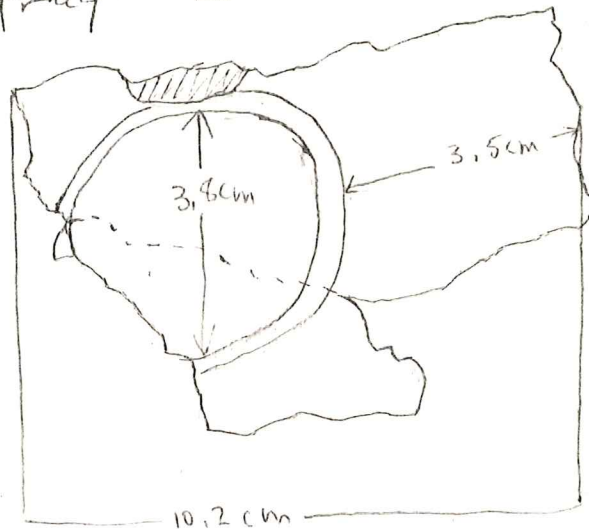

approx. thickness
0.6 cm

TEXAS

Date: 2 June 1981

No. PZ-81-63P

Object: Ring foot + entire profile of Gray Ware Material: Pottery

Square: J1-1 Butt. 12

Photograph:

E. side yellow

Level: Sand Fine Gravel

Drawing:

Dimensions: L.,

H., 5.3 cm.

W.,

Th.,

Technique: 8.0 cm. max. ext. diameter of ring foot.

Condition: Fragmentary + encrusted + scratched

Description:

(From PZ-81-60P).

This is a well preserved profile of a shallow bowl or deep plate of Gray ware. Glaze is even med. gray on interior, and goes down only 1/3 of way to ring foot on exterior. Glaze is cracked somewhat on exterior. Rim is high for a shallow form such as this, and wide. See drawing below.

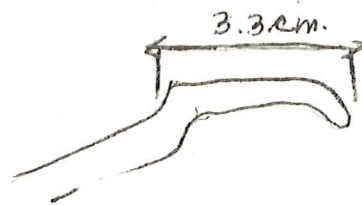

drawing not to scale

Estimated diameter 3.0 cm.

TEXAS

Date: 2 June 1981

No. PZ-81-64T

Object: loom weight

Material: Tenacotta

Square: J-1 Batt. 12

Photograph:

E. side yellow

Level: sand fine gravel

Drawing:

Dimensions: L.,

H.,

W.,

Th. a. 9 max. preserved

Technique: Diameter 7.2cm.

Condition: Chipped and encrusted and slightly burned

Description: Round loom weight. No decoration
This loom weight is irregularly colored.
Munsell: 2.5YR 5/6 Red

TEXAS

Date: 2 June 1981

No. PZ - 81-65 B

Object: Bone Frag.

Material: Bone

Square: J-1 Batt. 12
E. side yellow

Photograph:

Level: w/ Fine Gravel

Drawing:

Dimensions: L.,

H.,

W.,

Th.,

Technique:

Condition:

Description:

TEXAS

Date: 2 June 1981

No PZ 81 - 66W

Object: Wood chunks

Material: Wood

Square: J-1 Ball. D

Photograph:

E. Side Yellow

Level: Sand w/ fine gravel

Drawing:

Dimensions: L.,

H.,

W.,

Th.,

Technique:

Condition:

Description:

TEXAS

Date: 2 June 1981

No. PZ - 81 - 68P

Object: Most of Gray ware lamp Material: Pottery

Square: 5'-1 Batt. 12

Photograph:

Interface Gray T.

Drawing:

Level: yellow Virgin

Dimensions: L., 8.6cm (max. preserved) H., 2.95cm. W., 5.0cm. Th., of handle: 0.9cm.

Technique: interior diameter of top hole 2.0cm. 3.5cm. - diameter of base.

Condition: almost whole except for spout encrusted, worn.

Description: Small Gray ware lamp; complete except for part of the spout. Top center hole has incised ring around it and elevated rim which is slightly chipped. Handle is large for the size of the lamp and has several incised bands on it (going along the length of the handle). The body of the lamp flares up and outward from the flat base and slants inward.

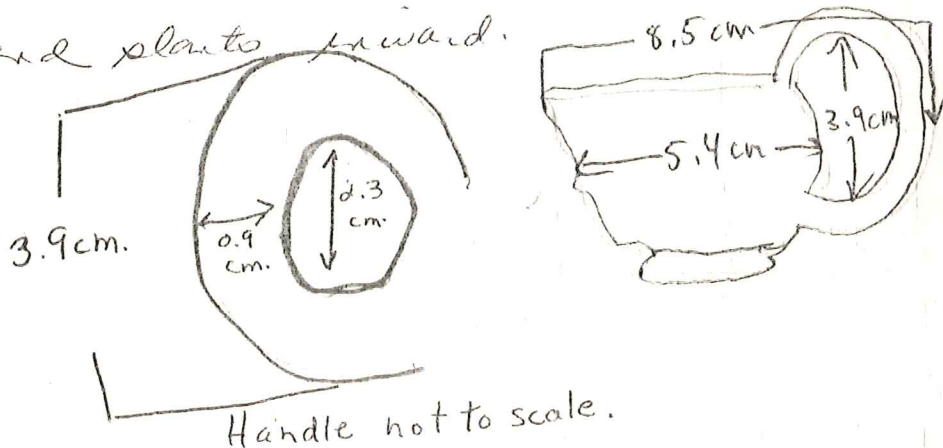

TEXAS

Date: 2 June 1981

No. PZ - 81 - 70 P

Object: Complete profile + ring foot of ^{shard} plate Material: Pottery

Square: J¹-1 Ball 12

Photograph:

Interface Gray, T

Level: Yellow Vignette

Drawing:

Dimensions: L.,

H., 3.7 cm.

W.,

Th.,

Technique: max. ext. diameter of ring foot 5.3 cm.

Condition: Encrusted, worn + fragmentary

Description: (from PZ - 81 - 69 PK) Gray Ware.

Feather band design incised around interior bottom of small plate. Slip applied evenly on inside, and dripping down to foot on outside.

Fragment comprised of 4 fragments.

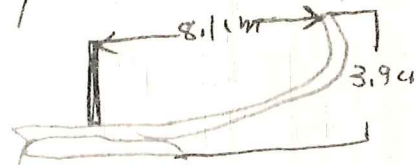
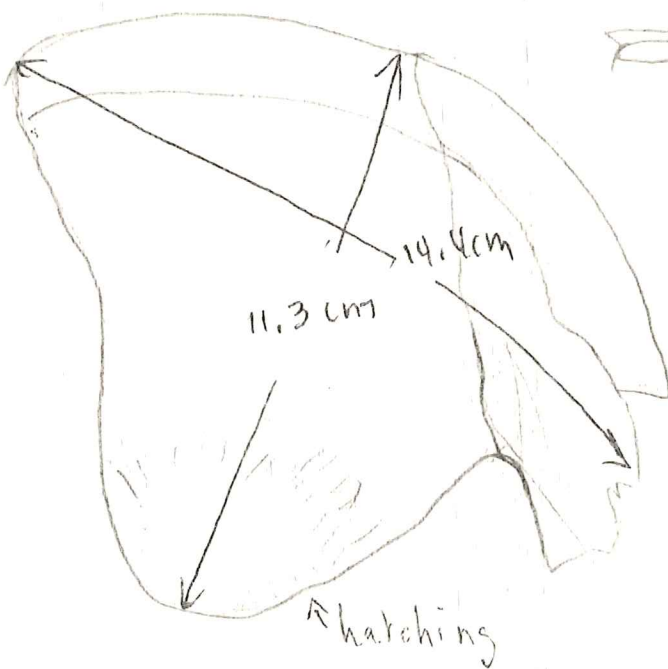

TEXAS

Date: 2 June 1981

No. PZ - 81-72P

Object: Moulded Gray Ware Body Sherd

Material: Pottery

Square: J'-1/J'41

Photograph:

Ball. 12 Gray
Level: Interface w/ Yellow
Virgin

Drawing:

Dimensions: L.,

H.,

W.,

Th.,

Technique:

Condition: Encrusted, worn, fragmentary

Description: (from PZ - 81-71PK)

Moulded triple leaf design above 2 parallel bands. Flower designs above + between the triple leaf motifs. There is a strange lump below the bottom band. Slip is completely worn off

thickness .05 cm

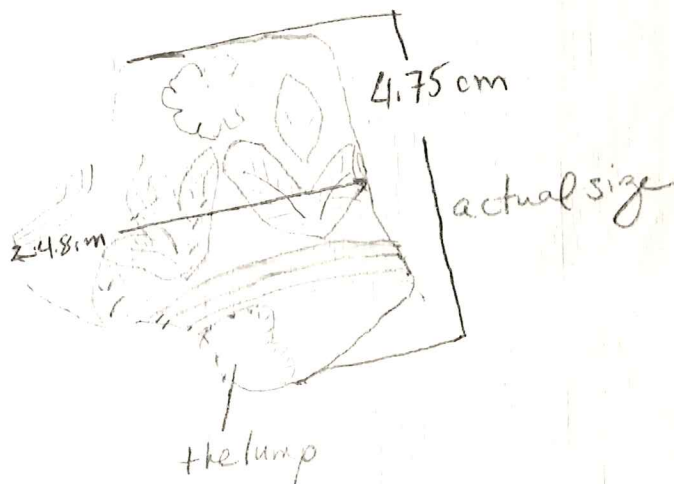

TEXAS

Date: 2 June 1981 No. PZ-81-73P

Object: Rim and portion of deep Gray Ware Bowl Material: Pottery

Square: J-1/I-1 Photograph:

East. 12 Gray Interior w/ Yellow Virgin Drawing:

Dimensions: L., H., 4.0cm. W., Th.,

Technique: From 4 sheds

Condition: - Chipped + fragmentary

Description: (from) PZ-81-71P2

Gray ware deep bowl 3 incised bands below rim on interior and on exterior. Above the three bands on interior is a raised ridge. On this ridge there is one potter's finger indentation. The rim tilts outwards at about 10° from vertical

note: From east of 3 shed bowl from PZ-80

TEXAS

Date:

2 June 1981

No.

PZ-81-74P

Object: Neck of Painted Large Jar

Material: Pottery

Square: 5'-1/E-1

Batt. 12 Gray

Level: ^{Interface of} Yellow Virgin

Photograph:

Drawing:

Dimensions: L.,

H., max. preserved W.,
15.4cm.

Th. of

Body 0.9cm.

Technique:

Condition:

Diameter:

Fragmentary w/ fresh breaks.

Th. of Rim 0.8cm.

Description:

(from PZ-81-71P2)

Large jar with flaring rim. Top of rim does have an indent, possibly for a lid. Dark red painted decoration preserved on inside of rim and on outside of neck. On neck design is of zig-zags (vertical). There is a wide painted band around the base of the neck.

Munsell: 2.5YR 6/8 (light red).

Missing piece found from PZ-81-268 PC found on June 11, 1981

TEXAS

Date: 2 June 1981

No. PZ-81 75P

Object: Rim and portion of body of Gray ware ^{plate or bowl} Material: Pottery

Square: J-1/I-1 Bld. 2 Photograph:

Level: Grey Interior of Yellow Vignette

Drawing:

Dimensions: L., H., 7.0cm. W., Th. of body: 0.6cm. 2.4cm.
 Technique: Diameter (max. preserved) - 11.0cm. Th. of lip: 0.6cm. 2.4cm.
 Condition: From 10 Shards - encrusted and chipped

Description: (from PZ-81-71 P2) Gray ware rim and part of plate. Outside slip is unevenly applied on lower part

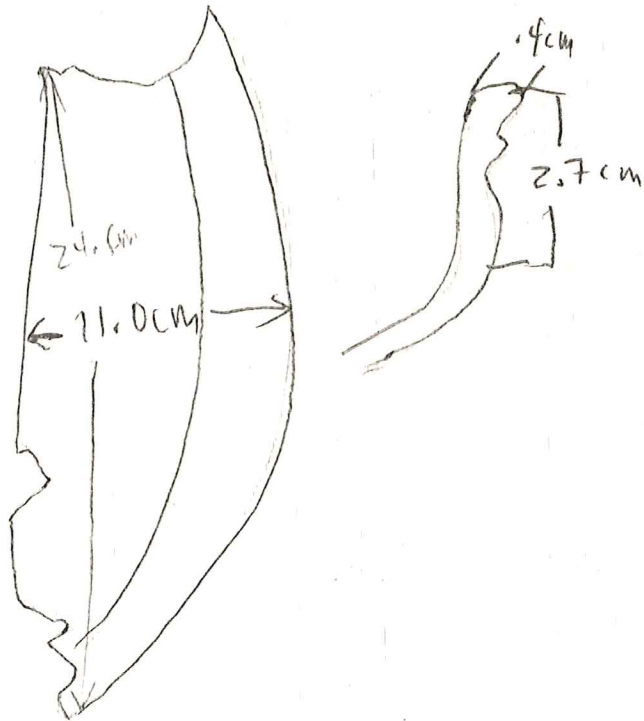

TEXAS

Date: 2 June 1981

No. PZ - 81 - 791

Object: Roof Tile Frag? Pan Tile ^{w/ finished edge}
Material: Tenacotta

Square: Ramp -

Photograph:

Clean-up
Level: Ball. 17

Drawing:

Dimensions: L. 22.5cm, H. 6.0cm, W. 10.5cm.

Technique: mat. preserved dimensions

Condition: Fragmentary + eroded

Description: Large ugly frag. of roof tile - Pan Tile
Finished edge is present.

TEXAS

Date: 2 June 1981

No. T2-81-80B

Object: Bone Frag

Material: Bone

Square: J'-1 (Batt. 2) Photograph:
to I'-1 Interface

Level: gray w/ yellow Drawing:

Dimensions: L., *virgin* H., W., Th.

Technique:

Condition:

Description: 2 unidentifiable frags - discarded.

TEXAS

Date: 2 June 1981

No. PZ -81-81 B

Object: Bone Slice

Material: Bone

Square: Upper level

Photograph:

Level: of Ramp to Trench

Drawing:

Dimensions: L.,

H.,

W.,

Th.,

Technique:

Condition:

Description:

TEXAS

Date: 2 June 1981

No. PZ-81-82 M

Object: Slag Chunk

Material: Slag-Metal

Square: Ramp Cleanup
Batt. 12

Photograph:

Level:

Drawing:

Dimensions: L.,

H.,

W.,

Th.,

Technique:

Condition: Crumbly

Description:

TEXAS

Date: 2 June 1981

No. PZ - 81 - 83B

Object: Bone Frag

Material: Bone

Square: J1-1/E1-1

Photograph:

Batt 12

Level: Gray Interface of Yellowed Virgin

Dimensions: L.,

H.,

W.,

Th.,

Technique:

Condition:

Description:

TEXAS

Date: 3 June 1981

No. PZ-81-86P

Object: Amphoriskos

Material: Pottery

Square: K1-1 ext. 14A
Gray-Brown Soil

Photograph:

Level:

Drawing:

Dimensions: L.,

H., 4.8cm.

W.,

Th.,

Technique:

(MAX PRESERVED)
Diameter of base - 2.2cm.

Condition:

Diameter of belly - 2.6cm.

Description:

(from PZ-81-85P2)

Orange glazed on interior - no glaze or decor.
on exterior. No rim remains, nor handle.
Trace of band decoration on neck -
Munsell 2.5YR 6/6 (light red).

TEXAS

Date: 2 June 1981

No. PZ-81-87B

Object: Cow Jaw

Material: Bone

Square: 5'-1/NW

Photograph:

Batt. 12

Level: Yellow to Gray

Drawing:

Dimensions: L.,

H.,

W.,

Th.,

Technique:

Condition:

Description:

TEXAS

Date: 2 June 1981

No. PZ-81-89B

Object: Bone

Material: Bone

Square: 5'-6" Batt. 19
to 5'-1" Gray Soil diag.
to N.W. Interface w/
Level: virgin Yellow Soil

Photograph:

Drawing:

Dimensions: L.,

H.,

W.,

Th.,

Technique:

Condition:

Description:

TEXAS

Date: 3 June 1981

No. PZ-81-91M

Object: Nail Frag.

Material: IRON

Square: K-1 Batt.

Photograph:

13A Gray

Level: Brown

Drawing:

Dimensions: L.,

H.,

W.,

Th.,

Technique: Max. Preserved Diam. 3.3 cm. } end of nail
 Condition: Max. Preserved Length 4.5 cm. }
 Oxidized and encrusted Fragmented.

Description:

Top of nail - head diam. - max preserved 3.2cm
 length of this top frag. 3.3cm.

Nail was freshly broken beneath head.
 This is in a poor state of preservation.
 There are lumps all over the surface,
 along with attached clay and bits
 of charcoal.

TEXAS

Date: 3-VI-81

No. P2-81-94T

Object: brick frags

Material: brick

Square: K1-1 Box 14A

Photograph:

gray brown soil

Level:

Drawing:

Dimensions: L.,

H.,

W.,

Th.,

Technique:

Condition: flaking - powdery

Description:

Brick frags.

TEXAS

Date: 3 June 1981

No. PZ-81-96T

Object: Loom Wt.

Material: Terracotta

Square: K^{L-1} Rock
P. 6 to Ball. 14A

Photograph:

Level:

Drawing:

Dimensions: L.,

H., 5.6cm. W., at base: 3.5cm

Technique:

W. at top 1.3cm.

Condition: Chipped, scratched + encrusted.

Description: (from PZ-81-95PL)

Full dimensions preserved on this pyramidal loom weight. Firing has made part of it buff colored. Clay color is: Munsell 5YR 7/4 (Pink)

TEXAS

Date:

3 June 1981

No. PZ-81-97T

Object: ? Roof Tile ^{Fragment of Cyma?} ^{avetto Moulding?} Material: Terra Cotta

Square: K1-1 Rock
Pile to 14A.

Photograph:

Level:

Drawing:

Dimensions: L., 9.2 cm.

H.,

W., 7.7 cm. Th.,

Technique:

Condition: Encrusted, Fragmentary and chipped

Description:

Strange shape. (From PZ-81-95 PL)

←
to
Bottom

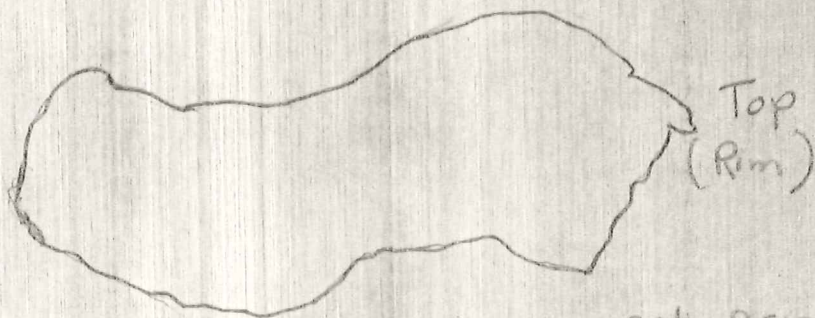

actual size
(side view)

TEXAS

Date: 3-VI-81

No. PZ 81-985

Object: BONES

Material: BONE

Square: K1-1 Rock
pile to Batt 14A

Photograph:

Level:

Drawing:

Dimensions: L.,

H.,

W.,

Th.,

Technique:

Condition:

Description:

- Bos taurus :
1. Left tibia - proximal end
 5. (Right) anterior 2nd phalanx.
 7. Metacarpus - shaft frag.
 9. Axis - antero-ventral frag
 10. Right astragalus frag.

- Equus caballus
2. Left metatarsus
 3. Left tibial epiphysis - large juvenile.

- Ovis/ Capra
6. Right tibia - shaft frag. - gnawed at both ends
 11. Left radius - shaft frag. - cut marks.

- Canis familiaris
12. Left dorsal cranium frag - juvenile?
 - ? 14. Cranium frag.

- Large Un.Id.
4. Rib shaft frag
 8. long bone shaft frag.
 16. Un Id frag.

- Medium large Un Id.
13. Humerus shaft frag
 15. Tibia shaft frag
 18. Pelvis? frag

- Medium Un Id
17. Scapula frag.
 19. 4 Un Id frags.

TEXAS

Date: 3-VI-81

No. P2-81-100B

Object: Misc. BONES

Material: BONE

Square: K1 - 1 BATH A

Photograph:

Gray Brown

Level:

Drawing:

Dimensions: L.,

H.,

W.,

Th.,

Technique:

Condition:

Description:

TEXAS

Date: 3-VI-81

No. P2-81-101B

Object: Misc BONES

Material: BONE

Square: K1-1 Box 13A
Gr-Brown

Photograph:

Level:

Drawing:

Dimensions: L.,

H.,

W.,

Th.,

Technique:

Condition:

Description:

TEXAS

Date: 3 June 1981

No. PE-81-102P

Object: Gray Ware Spout

Material: Pottery

Square: K1-1/J1-1 (Gray - Photograph: Brown to Yellow)

Batt. 14A NW
Level: Quad. In Cobble Drawing:

Dimensions: L., H., W., Th.,

Technique:

Condition: Chipped, scratched, fragmentary.

Description: One interior hole leading to spout. Difficult to tell from this piece what the shape of this vessel was.

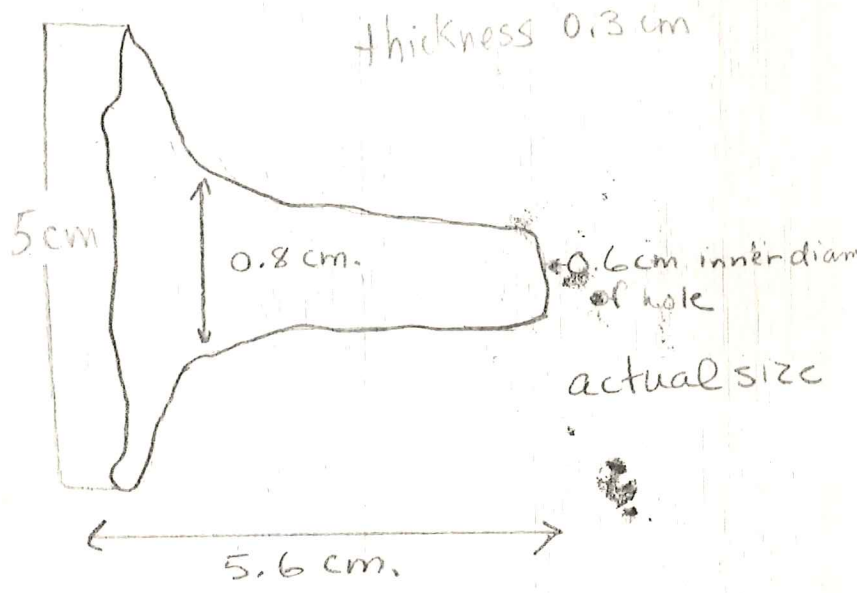

TEXAS

Date: 3-VI-81

No. PZ-81-103B

Object: MISC. BONES

Material: BONE

Square: K1-1 Balt 13A
Gray Brown

Photograph:

Level:

Drawing:

Dimensions: L.,

H.,

W.,

Th.,

Technique:

Condition:

Description:

TEXAS

Date: 3-VI-81

No. PZ-81-104 B

Object: Misc. Boxes

Material: BONE

Square: K1-1 to J1-1
Batt 13 A
gr-Br to yellow w/ fine
Level: gravel

Photograph:

Drawing:

Dimensions: L.,

H.,

W.,

Th.,

Technique:

Condition:

Description:

TEXAS

Date: 3-VI-81

No. PZ-81-105 T

Object: Loom wt

Material: Terracotta

Square: K-1 Balt 14A
Gray Brown

Photograph:

Level:

Drawing:

Dimensions: L.

7.3 cm

H.

W.

Th.

Technique:

max preserved diameter.

2.1 cm

non-preserved.

Condition: encrusted and chipped.

Description:

Munsell 5YR 7/4 (Pink)

buff on ^{fired} side. loom wt. in good condition -
Buff color is Munsell 2.5Y 8/2 (white)

TEXAS

Date: 3-VI-81

No. PZ-81-106T A, B, C, D

Object: Loom wts - 4

Material: Terracotta

Square: K1-1 Batt 13A

Photograph:

Gray Brown or Oxid.

Level: Level of 2-VI-81

Drawing:

Dimensions: L., H., W., Th.

Technique: A 10.5 max preserved ht.
 B 6.4 max preserved wt.
 C 9cm max preserved w. approx.
 D 7.2cm max preserved L.
 Condition: Encrusted and chipped.

Description:

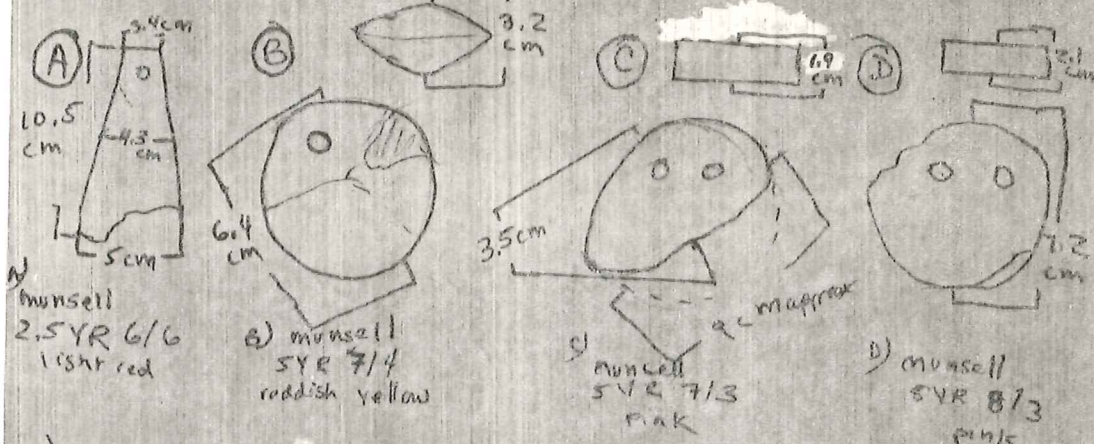

- A) pyramidal loom wt. bottom broken off. back side severely chipped.
- B) biconical loom wt. fairly good condition except for one large chip - only has one hole.
- C) half of a eyebrow loom wt. part remaining is in fairly good shape.
- D) circular loom wt. - one side well preserved - back very irregular. two holes on top.

* none have visible stamps

TEXAS

Date: 3-VI-81

No. PZ-81-107T

Object: loom wt.

Material: terracotta

Square: K1-1 Rock pile to Batt. 144

Photograph:

Level:

Drawing:

Dimensions: L.,

H.,

W.,

Th. 2.5cm.

Technique: 7cm max preserved diameter.

Condition: chipped and encrusted

Description:

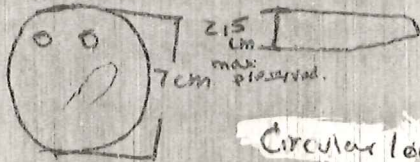

Circular loom wt. Bottom part - Munsey
 2.5 YR 6/6 light red - Top part - Munsey
 7.5 YR 7/4 pink - Top side (loom)
 Munsey 10 YR 8/1 white, color possibly
 changed due to firing. Condition fairly
 good except for large chip on back side.
 No visible stamp mark.

TEXAS

Date: 3 June 1981

No. PZ-81-108T

Object: Roof Tile Frag. (Pan Tile) Material: Terra cotta

Square: K1-1 Bldg. 13A Photograph:
Gray Brown (Original)

Level:

Drawing:

Dimensions: L.,

H.,

W.,

Th., 4.6cm.

Technique: Max. Preserved length 6.0cm.

(max. preserved)

Condition: Fragmentary and encrusted - Poor

Description: On the back of this uncurved roof tile there are 2 indented finger-made stripes cutting diagonally across the grain of the clay.

Munsell: 5YR 5/4 (reddish brown) on outside
Color is black in interior of the tile; due to
firing (heavily fired)



TEXAS

Date: 3-VI-81

No. PZ-81-10155

Object: Lime?

Material: Lime?

Square: K1-1

Photograph:

Batt 13 A N. end Gray
Br. to yellow w/ fine gravel
Level:

Drawing:

Dimensions: L.,

H.,

W.,

Th.,

Technique:

Condition:

Description:

Clumps of white powdery material

TEXAS

Date: 3 June 1981

No. PZ-81-110T

Object: Oval Stamp

Material: Terracotta

Source: K¹-1 Batt. 13A

Photograph:

Gray Brown
(3 m. or w. side from
Level: S. Wall.)

Drawing:

Dimensions: L.,

H., 3.0cm.

W., 2.9cm.
(max)

Th., 1.0cm.
(max)

Technique:

Condition: Good - small scratches, encrustations, small

Description:

chip at top.

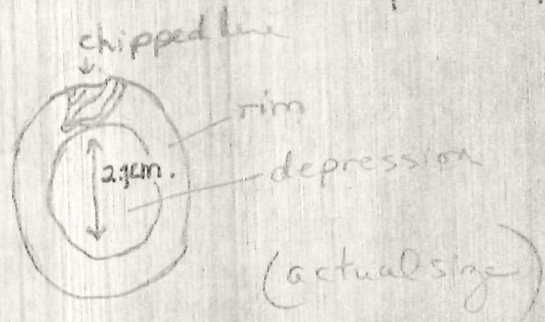

Munsell - 10R 4/6 (Red)

The stamp is almost flat in the center of the back. On the front, in the depression is a relief of a winged female. She has voluminous pleated robes on, which are drawn up in front of her. Her wing (only one is showing; she stands sideways giving us a profile view) is very long, almost touching the ground. There is a thin line for the ground, and on the ground in front of her. She may be holding a

TEXAS

Date: 3-VI-81

No. PZ-81-111 W

Object: Slag

Material: Slag

Square: K'-1 / J'-1
Batt 14 A Niwqued
Gray-brown to yellow
Level: cobble patch

Photograph:

Drawing:

Dimensions: L.,

H.,

W.,

Th.,

Technique:

Condition:

Description: slag (1 big piece)

TEXAS

Date: 3-VI-81

No. PE-81-112m

Object: Slag

Material: Slag

Square: K-1 Batt. BA
Gray Brown

Photograph:

Level:

Drawing:

Dimensions: L.,

H.,

W.,

Th.,

Technique:

Condition: Crumbly

Description: 2 Big Heavy Chunks

TEXAS

Date:

3 June 1981

No. PZ-81-113 M

Object:

Slag

Material:

Slag

Square:

K1-1 Rock
Pile to Ball. 14A

Photograph:

Level:

Drawing:

Dimensions: L.,

H.,

W.,

Th.,

Technique:

Condition:

Crumbly

Description:

3 Small Chunks

TEXAS

Date: 3-VI-81

No. PZ-81-114 M

Object: Slag

Material: Slag

Square: K1-1 Batt 14A

Photograph:

Level: Gray Brown

Drawing:

Dimensions: L.,

H.,

W.,

Th.,

Technique:

Condition:

Description:

2 Pieces of Slag.

TEXAS

Date: 3 June 1981

No. PZ-81-115T

Object: Brick Chunks

Material: Brick

Square: K-1 to J-1
Batt. 13A Gray-Brown
to Yell. w/ Fine
Level: Gravel

Photograph:

Drawing:

Dimensions: L.,

H.,

W.,

Th.,

Technique:

Condition: Crumbly and Fragmentary - Poor

Description: Color is varied, but majority
shade is Munsell 2.5YR 4/6 (Red)

TEXAS

Date: 3-VI-81

No. PZ-81- 116 M

Object: Slag

Material: Slag

Square: K1-1 Batt 13A

Photograph:

Gray Brown or orange.

Level: level of 2-VI-81

Drawing:

Dimensions: L.,

H.,

W.,

Th.,

Technique:

Condition:

Description:

5 pieces of slag 3 big & small
some very dark pieces.

TEXAS

Date: 2-VI-81

No. PZ-81-117 g

Object: Glass

Material: glass

Square: J-1 Bath 13A
Gray Brown - Center trench
just to N. of K-1 / J-1 line
Level:

Photograph:

Drawing:

Dimensions: L.,

H.,

W.,

Th.,

Technique:

Condition: flaking

Description:

Small frag of glass. Very fragile
flaking. one side light blue - reverse side
white - Piece is possibly from a rim.

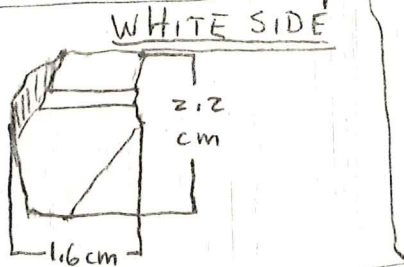

Piece looks the same after
conservation.

TEXAS

Date: 4 June 1981 PR-81 -118B

Object: Burned Bone Frag

Material: Bone

Square: J'-1 Batt.

Photograph:

14A

Level: Gr.-Br

Drawing:

Dimensions: L.,

H.,

W.,

Th.,

Technique:

Condition:

Description:

TEXAS

Date: 4 June 1981

No. PZ-81-119B

Object: Boxes

Material: Bone

Square: K1-1 Bath. 15A

Photograph:

Level: Gray Brown
S. Half

Drawing:

Dimensions: L.,

H.,

W.,

Th.,

Technique:

Condition:

Description:

TEXAS

Date: 4 June 1981

No. PZ-81-120B

Object: Bones

Material: Bone

Square: K1-1 Batt.

Photograph:

N. half - east 15A

Level: Grey Brown

Drawing:

Dimensions: L.,

H.,

W.,

Th.,

Technique:

Condition:

Description:

TEXAS

Date: 4 June 1981

No. PZ-81-121B

Object: Bones

Material: Bone

Square: K'-1 Batt. 16A

Photograph:

Gray-Brown
Level: S. E. Quad.

Drawing:

Dimensions: L.,

H.,

W.,

Th.,

Technique:

Condition:

Description:

TEXAS

Date: 4 June 1981

No. PZ-81-122B

Object: Bones

Material: Bone

Square: K1-1 Batt. 16A

Photograph:

Level: Gray Brown

Drawing:

Dimensions: L.,

H.,

W.,

Th.,

Technique:

Condition:

Description:

TEXAS

Date: 4 June 1981

No. PZ-81-123B

Object: Bones

Material: Bone

Square:

Photograph:

K1-1 Batt. 15A

Level: N-W Quad Gr. Br. Drawing:

Dimensions: L.,

H.,

W.,

Th.,

Technique:

Condition:

Description:

TEXAS

Date: 4 June 1981

No. PZ-81-124B

Object: Bone Frag

Material: Bone

Square: K¹-1 Batt.

Photograph:

16A S.E. Quad

Level: Gray Brown

Drawing:

Dimensions: L.,

H.,

W.,

Th.,

Technique:

Condition:

Description:

TEXAS

Date: 4 June 1981

No. PZ-81 - 175B

Object: Bone

Material: Bone

Square: K1-1 Batt. 164

Photograph:

Gray-Brown
Level: S. Side

Drawing:

Dimensions: L.,

H.,

W.,

Th.,

Technique:

Condition:

Description:

TEXAS

Date: 4 June 1981

No. PZ - 81 - 126B

Object: Bone

Material: Bone

Square: K' - 1 Bott. 16A

Photograph:

Gray-Brown to
Level: Light Gray-Gray
E. IS.

Drawing:

Dimensions: L.,

H.,

W.,

Th.,

Technique:

Condition:

Description:

TEXAS

Date: 4 June 1981

No. PZ-81-127B

Object: Bone

Material: Bone

Square: K1-1 Batt. 16A
Gray-Brown to the
Level: Rock Conc.

Photograph:

Drawing:

Dimensions: L.,

H.,

W.,

Th.,

Technique:

Condition:

Description:

TEXAS

Date: 4 June 1981

No. PE-81-128B

Object: Bone

Material: Bone

Square: K1-1 Batt. 16A
Gray-Brown to the
Level: Rock Conc.

Photograph:

Drawing:

Dimensions: L.,

H.,

W.,

Th.,

Technique:

Condition:

Description:

TEXAS

Date: 4 June 1981

No. PZ-81-129B

Object: Bone

Material: BONE

Square: J'-1/K'-1
Batt. 16A Light GR.

Photograph:

Level: NE of Sect. A

Drawing:

Dimensions: L.,

H.,

W.,

Th.,

Technique:

Condition:

Description:

TEXAS

Date: 4-VI-81

No. PZ-81-131 T

Object: loom wt.

Material: Terrazo #2

Square: J'-1 Bahl 14A
Gray-Brown

Photograph:

Level:

Drawing:

Dimensions: L.,

H.,

W.,

Th.,

Technique: 7.2^{cm} max preserved diameter

Condition: chipped and smoothed.

Description:

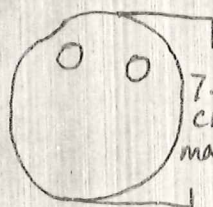

7.2
cm
max preserved



1.9 cm max.

Circular loom wt. in fairly good condition. large chip on back side - no visible stamp.

Mursell 5YR 7/6; reddish yellow

TEXAS

Date: 4 June 1981

No. PE-81-1325

Object: Part of basalt wheel-slope Material: Stone

Square: J-1 Batt. 144
Gray Brown

Photograph:

Level:

Drawing:

Dimensions: L.,

H.,

W.,

Th.,

Technique:

Condition: Fragmentary

Description: There is a flat and inclining side and on the opposite side there is a flat part inclining up to a rounded edge.

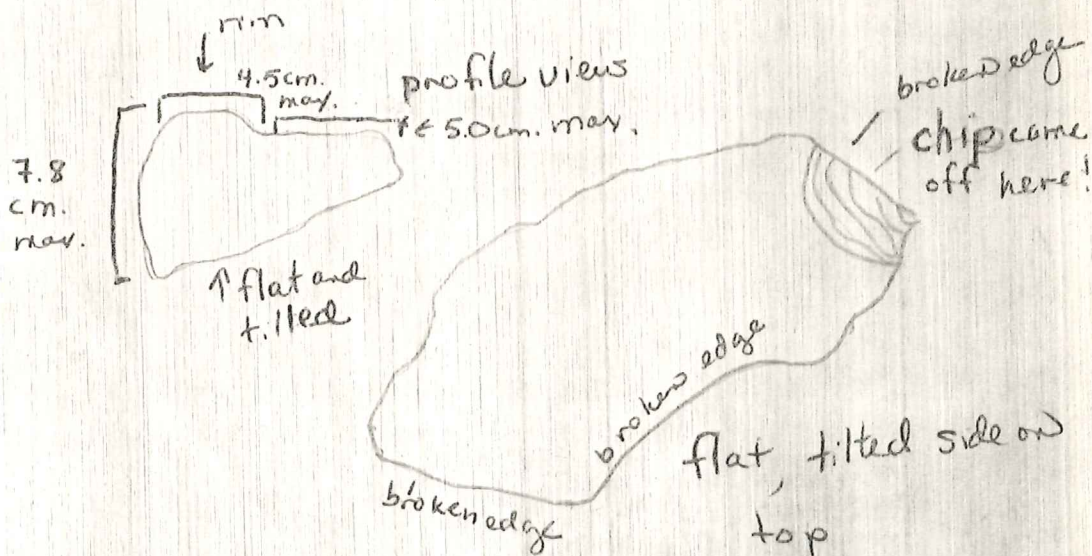

(drawing not to scale)

This fragment looks like part of a basalt grinding stone, but this cataloguer could not see any grinding marks in the stone.

TEXAS

Date: 4-VI-81

No. PZ-81-135 P

Object: ^{Body, Rim + Handle of Banded Ware} Fragment of Jar Material: clay pottery

Square: K1-1 Batt
15A North 1/2 - East

Photograph:

Level: Gray brown soil

Drawing:

Dimensions: L., H., 7.5 cm W., Th., 0.5 cm

Technique:

Th. of handle: 0.4 cm

Condition: slightly encrusted

Description:

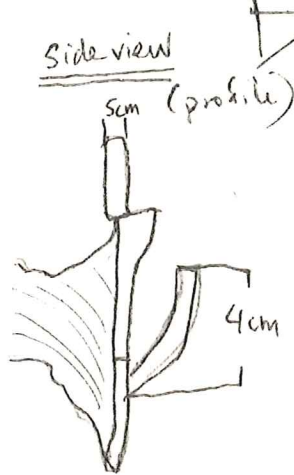
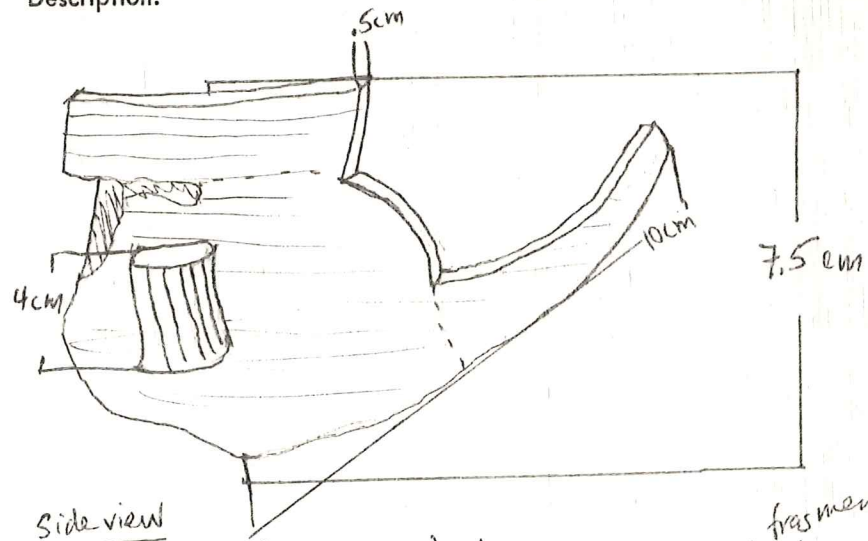

Wheel rimmed vessel ^{fragment} (possibly a jar).
Very poorly fired glaze -
Handle decorated with 4 incised lines.

Munsell 2.5YR 6/6 jar red.

Sherd added from PZ-81-142 PL
K1-1 BATT 16A - GRAY BR. SOIL

TEXAS

Date: 4 June 1981

No. PZ -81-136 P(A+B)

Object: 2 Frag. orangewear vessel Material: pottery

Square: K¹-1 Batt. 15A
North 1/2 - East
Level: Gray Brown

Photograph:

Drawing:

Dimensions: L., H., W., Th.,

Technique:

Condition: Fragmentary - Pieces do not join

Description: (from PZ-81-134 PA)
A - Rim section joined to handle. Small rim with 8 incised bands ^{going} around the vessel below rim. Handle has 3 incised bands and 2 circles of clay applied at either side where it joins the body of the vessel.

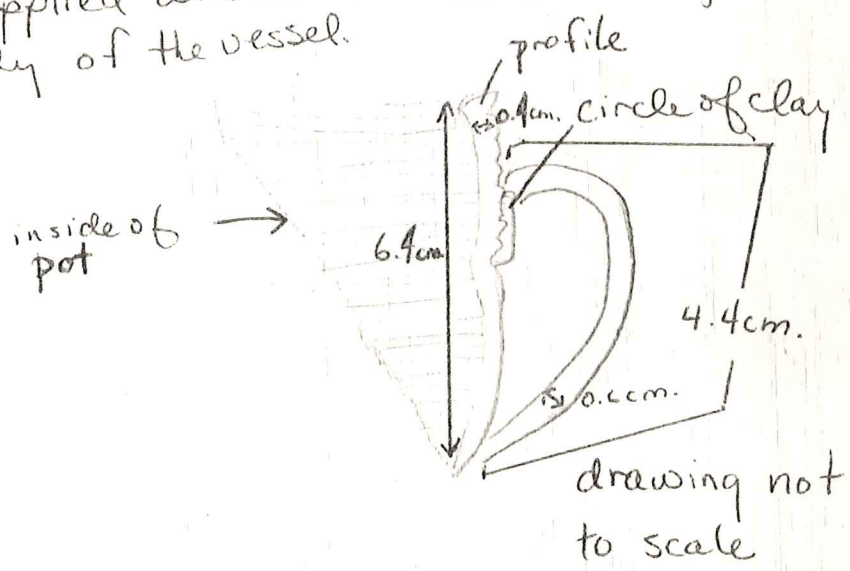

B. Another portion of the rim of same vessel. Comprises 4 strands. On both pieces the slip is worn and flaky. It is orange, and was applied both to the interior and exterior of the vessel.

4.6 cm. max.



TEXAS

Date: 4 June 1981 After Conservation/Restoration.
 No. PZ-81-136 P (cont'd).

Object: Orange glazed, wheel ridged cup - almost complete
 Material: Pottery

Square: K-1 Batt. 15A
 N. 1/2 East Gray-Brown
 and R-1 Batt. 15A
 Level: G-1-B, E site etc.

Photograph:

Drawing:

Dimensions: L., H., including foot 10.8 cm. W., Ht. w/out foot: 10.3 cm. Th., of rim 0.5 cm. of handle 0.7 cm.

Technique: Interior diameter at rim 8.5 cm.

Condition: Diameter of base 9.6 cm.
 Comprising 28 fragments. Fair condition -

Description: (from PZ-81-134 PL) slightly encrusted, glaze is worn.
 The fragments making up this cup are from PZ-81-136 PA+B and a collection of fragments found & bagged separately by the excavator, CP.

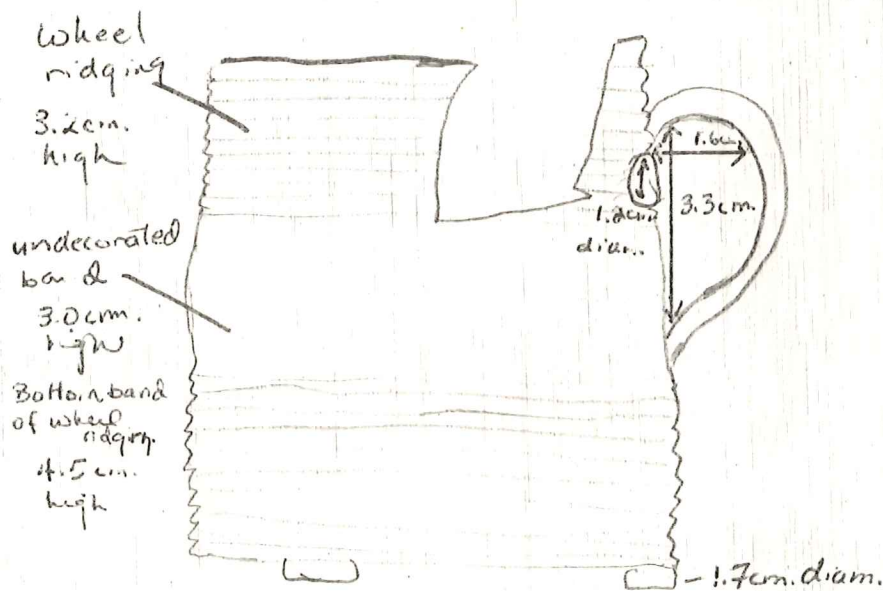

Most noteworthy features are the handle with 3 incised bands, and the circles (flat) of clay applied as feet (3) and applied next to the top of the handle (2).

Munsell: Clay: 5YR 7/6 Reddish Yellow

Glaze: 2.5YR 6/8 Light Red

Glaze covered all of interior and all of exterior

TEXAS

Date: 4 June 1981

No. PZ-81-137P

Object: Fragment of Vessel
W/ Strainer

Material: Pottery

Square: K'-1 Batt. 15A
N. 1/2 E. Gray Branch

Photograph:

Level:

Drawing:

Dimensions: L.,

H.,

W.,

Th.,

Technique: fabric - is a semi-fine coarse ware. Feels soft.

Condition: Fragmentary - decoration in good preservation

Description: (from PZ-81-134P)

This is a large strainer section with some of the spout and some of the vessel wall intact. There are 30 holes in the strainer. The dark brown banded decoration was brushed on in wide swathes around the base of the spout. Munsell 5YR 8/3 (Pink)

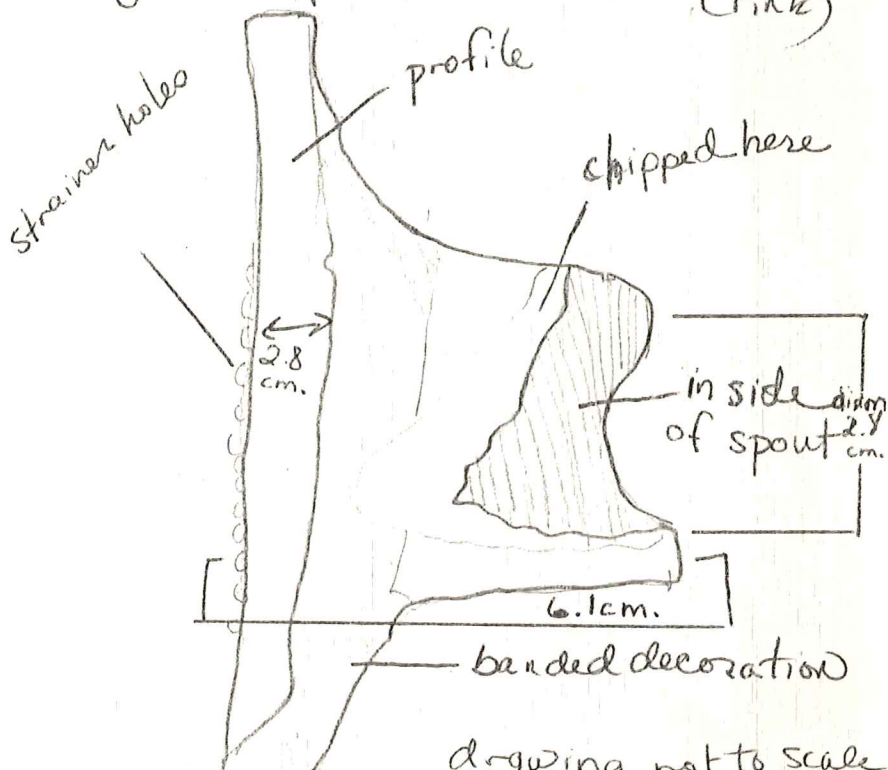

TEXAS

Date: 4 June 1981

No. PZ-81-138T

Object: ? Votive Frag.?

Material: Terra Cotta

Square: K'-1 Batt. 15A
N $\frac{1}{2}$ E. Gray

Photograph:

Level: Brown

Drawing:

Dimensions: L.,

H., Max. Preserved? W.,

Th., Max

Technique:

4.6cm.

Preserved: 1.0cm.

Condition: Fragmentary

Description: (from PZ-81-134 P2)

Munsell 5YR 7/4 (Pink)

inside of piece

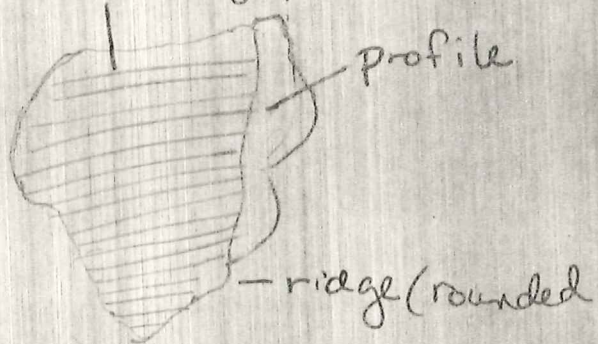

Inside is rounded while outside has 2 large rounded ribs and a small ridge below. Reclining figure plaque fragment?

TEXAS

Date: 4-VI-81

No. P2-81-140 T

Object: loom wt.

Material: Terracotta

Square: K-1 Bath ISA
NW Quad Gray Brown
to tile and Rock concentration
Level: and yellow

Photograph:

Drawing:

Dimensions: L., 7.2 cm H., max preserved.

W.,

Th.,

Technique:

Condition: fair-

Description:

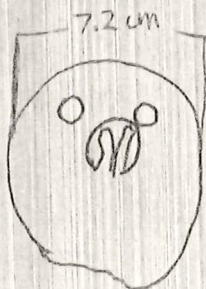

Circular loom wt. in fairly good condition - Munsell 5YR 7/4 pink. Stamp mark near two holes - bottom of loom wt. chipped.

TEXAS

Date: 4 June 1981

No. PZ-81-146M

Object: One Slag Chunk

Material: Slag

Square: J'-1 Batt. 14A
Gr-Br

Photograph:

Level:

Drawing:

Dimensions: L.,

H.,

W.,

Th.,

Technique:

Condition: Crumbly

Description:

Matrix is rusty-colored and gray with charcoal bits.

TEXAS

Date: 4 June 1981

No. PZ-81-147M

Object: Slag

Material: Slag

Square: K-1 Batt. 15A

Photograph:

Gr.-Br. S. 1/2 -

Level:

Drawing:

Dimensions: L.,

H.,

W.,

Th.,

Technique:

Condition: Crumbly

Description: 2 large chunks, 1 small chunk

TEXAS

Date: 4 June 1981

No. PZ-81-148M

Object: Small Metal Chip

Material: Bronze?

Square: K'-1 Batt. 15A

Photograph:

Gray-Brown.

Level:

Drawing:

Dimensions: L.,

H.,

W.,

Th.,

Technique:

Condition: Fragmentary, corroded, crumbling - Poor

Description: Small piece of metal. Probably either copper or bronze because of the green color of some areas. There are raised areas on the surface of the metal caused by corrosion.

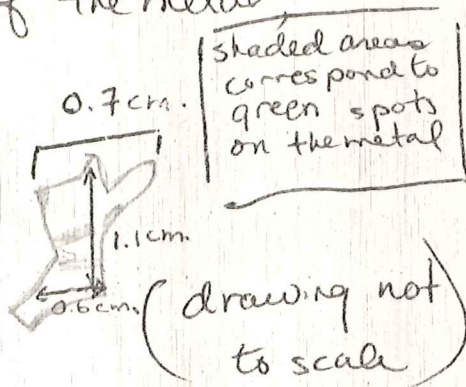

TEXAS

Date: 4-6-81

No. PZ - 81 - 149BS

Object: One frag. of a shell

Material: Shell

Square: K1-1 Bath: 15A

Photograph:

Gray-Brown

Level:

Drawing:

Dimensions: L.,

H.,

W.,

Th.,

Technique:

Condition: Fragmentary and eroded.

Description:

TEXAS

Date: 4-VI-81

No. P2-81-150T

Object: Terracotta head - Antefix?

Material: Terracotta

Square: near edge of excavated area, on way to back dirt
Level: out of context

Photograph:

Drawing:

Dimensions: L.,

H.,

W.,

Th.,

Technique:

Condition: chipped and eroded (good).

Description:

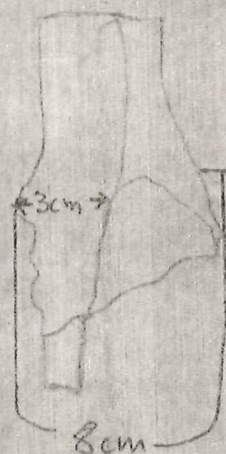
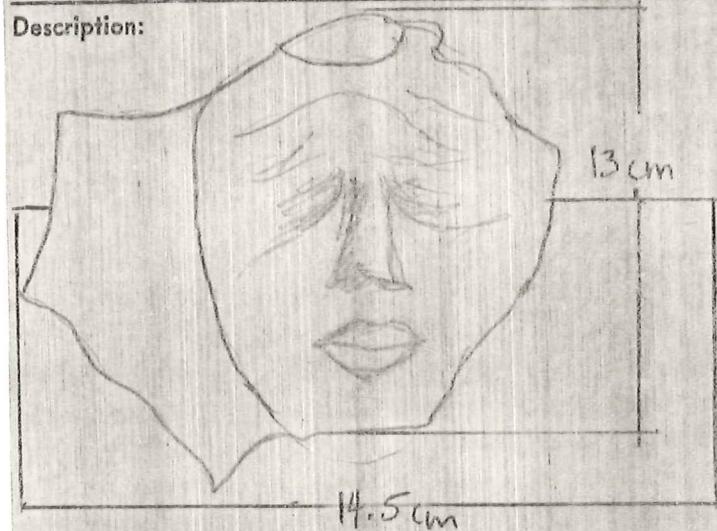

This head (possibly belonging to an antefix) was found exposed near the excavation. On its right, its terracotta mounting remains. The head has been chipped at the chin and at its left side. It seems to have a very elaborate hair which is capped off on top by a bun.

It appears to be munsell 2.5 YR 6/6 light red.

TEXAS

Date:

5 June 1981

No.

PZ - 81 - 1515

Object:

Piece of Basalt

Material:

Basalt

Square:

K-1 Batt. 17A

Photograph:

Rock Conc. +

Level:

Below

Drawing:

Dimensions: L.,

H.,

W.,

Th.,

Technique:

Condition: Rocky

Description:

(from PZ-81-167PL)
Black porous volcanic rock. No signs of
grinder marks. Orange paint smudges in
places

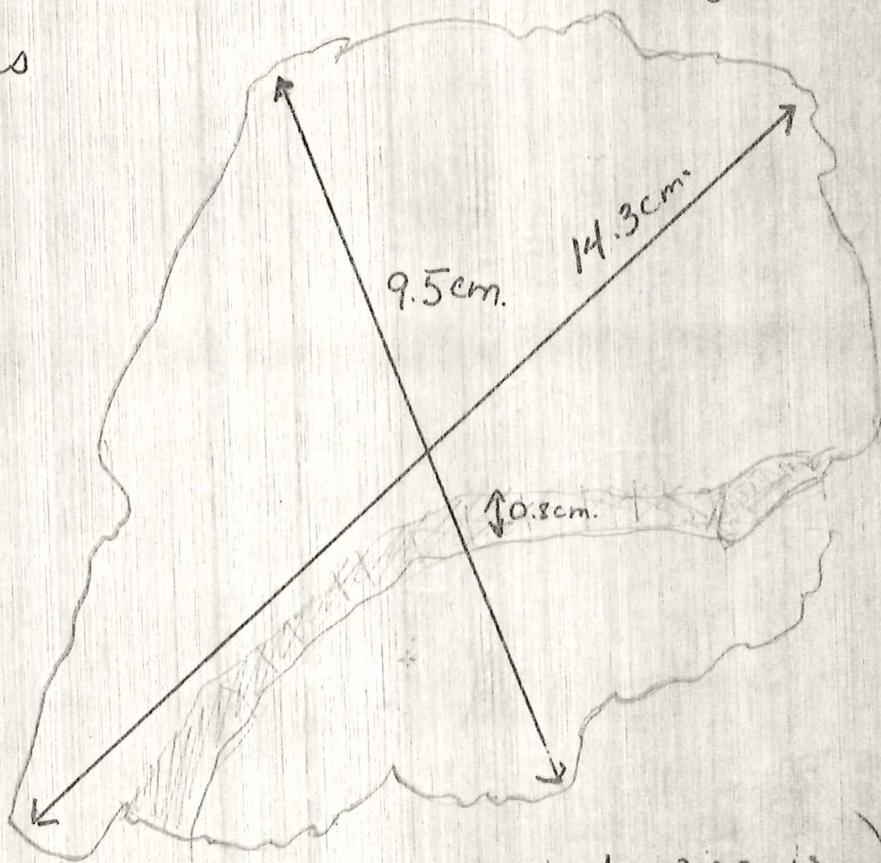

(drawing is
actual size)

TEXAS

Date: 4 June 1981

No. PZ -81-152M

Object: Slag.

Material: Slag

Square: K'-1 Batt. 15A

Photograph:

N. 1/2 - E.
Level: Gr. Br.

Drawing:

Dimensions: L.,

H.,

W.,

Th.,

Technique:

Condition: Crumbly and Eroded

Description: several chunks.

TEXAS

Date: 4 June 1981

No. PZ -81 153T

Object: Brick Frag.

Material: Baked Clay

Square: K1-1 Batt.
15A

Photograph:

Level: N. 1/2 - East
Gray-Brown

Drawing:

Dimensions: L.,

H.,

W.,

Th.,

Technique:

Condition:

Description:

Munsell: 5YR 4/4 Reddish brown
and black.

This fragment looks as though it could have
been burned because of the blackened
areas.

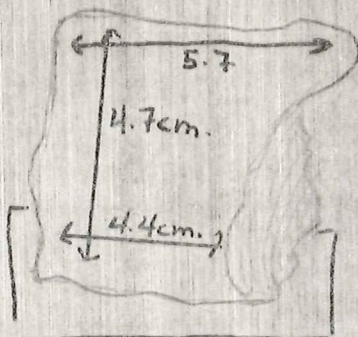

(drawing not to scale)

6.7 cm.

TEXAS

Date: 4 June 198

No. PZ-81-154ND

Object: Slag Chunks

Material: Slag

Square: K1-1 Batt. 15

Photograph:

N W Quad. Gray

Level Brown to Rock. Conc

Drawing:

Dimensions: L.,

H.,

W.,

Th.,

Technique:

Condition: Crumbly and crusty

Description: 3 chunks

TEXAS

Date: 4 June 1981

No. PZ-81-155SS

Object: Bit of Plaster or Lime

Material: ?

Square: K'-1 Batt. 151

Photograph:

Gray-Brown

Level: Tile Core.

Drawing:

Dimensions: L.,

H.,

W.,

Th.,

Technique:

Condition:

Description:

TEXAS

Date: 4 June 1981

No. PZ-81-156 M

Object: Slag or Metal

Material: Metal

Square: K-1 Ball. 16A
Gray Brown

Photograph:

Level:

Drawing:

Dimensions: L.,

H.,

W.,

Th.,

Technique:

Condition: Crumbly and encrusted + corroded

Description: This metal seems heavier than regular slag. The shape of the piece drawn suggests a spear or other projectile point immediately below.

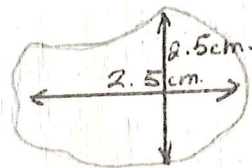
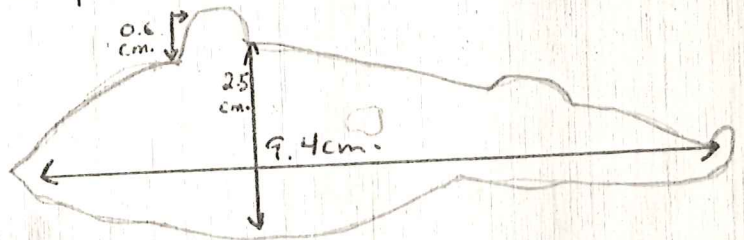

drawing not to scale

Both pieces are corroded all over. They are bumpy all over, and of dark brown, gray, and orange shades.

Both pieces have had some of the corrosion removed with a scalpel. Both pieces retain their shape as drawn above, but with fewer large bumps. The piece drawn on top of this page looks very much like a projectile

TEXAS

Date: 4-VI-81

No. P2-81-157 M

Object: Slag pieces

Material: Slag

Square: K1-1 Battle
gray Brown

Photograph:

Level:

Drawing:

Dimensions: L.,

H.,

W.,

Th.,

Technique:

Condition:

Description:

2 big pieces and one small of slag

TEXAS

Date: 4-VI-81

No. P2-81-158 m

Object: metal (Bronze?)

Material: Bronze?

Square: K1-1 batt 16 ft
2.5 meters on east
wall - Slat brown to
Level: light gray

Photograph:

Drawing:

Dimensions: L.,

H.,

W.,

Th.,

Technique:

Condition:

Description:

Thin pieces of bronze attached to soil.
one big piece and many crumbs.

TEXAS

Date: 4-VI-81

No. PZ-81-159 SS

Object: charcoal

Material: charcoal

Square: 1C1-1 BATH A Photograph:
gray brown to rock

and tile concentration
Level:

Drawing:

Dimensions: L.,

H.,

W.,

Th.,

Technique:

Condition:

Description:

2 big and several small pieces of charcoal.

TEXAS

Date: 4-VI-81

No. PZ-81-160B

Object: snail

Material: aragonite

Square: K1-1 Bath 16A
Rock + Tile Concentr.

Photograph:

Level:

Drawing:

Dimensions: L.,

H.,

W.,

Th.,

Technique:

Condition: top is chipped.

Description:

bottom half of snail inside filled with dirt.

TEXAS

Date: 5-VI-81

No. PZ-81-163 P

Object: Amphora neck ^{Rim, handles, neck + body.} Material: Pottery

Square: K1-1, Batt
17A -
tile + rock con.

Photograph:

Level:

Drawing:

Dimensions: L., H., 40 cm W., 26 cm Th., top 1.3 cm
base 1.6 cm

Technique: Interior diameter of neck - 6.5 cm.

Condition: Good - slightly encrusted + scratched.

at shoulder - 2.0 cm.

Description: (PZ-81-162 PL)

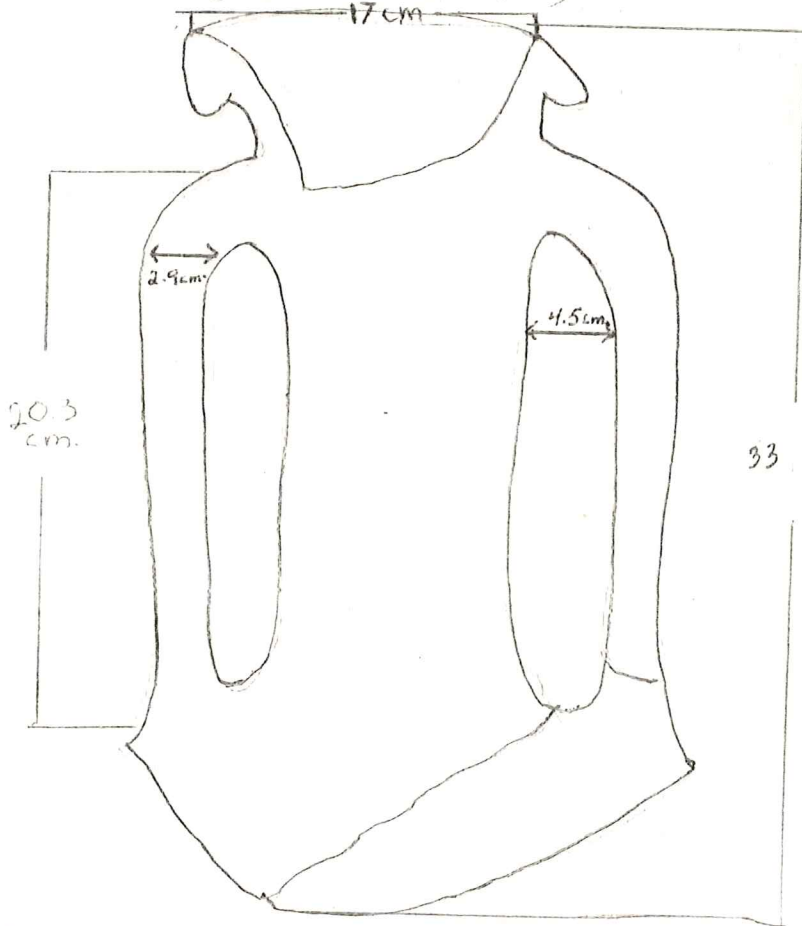

Amphora neck
in 6 pieces.
Neck from a
very large
storage vessel -
rim of neck
chipped.

After conservation
the glued portion
33 cm comprises
4 sherds, the
other 2 did
not join.

Munsell 5YR 7/4 Pink -

TEXAS

Date: 5 June 1981

No. PZ - 81 - 168 P

Object: Gray Ware Plate (1q. portion) Material: Pottery

Square: K¹-1 Batt. 17A Photograph:
Rock Conc. + Below

Level: Drawing:

Dimensions: L., H., W., Th.,

Technique:

Condition: 9 Fragments. Ceramic is slightly scratched.

Description: (from PZ - 81 - 167 PK)

Gray ware plate with vertical rim. No ring foot recovered.

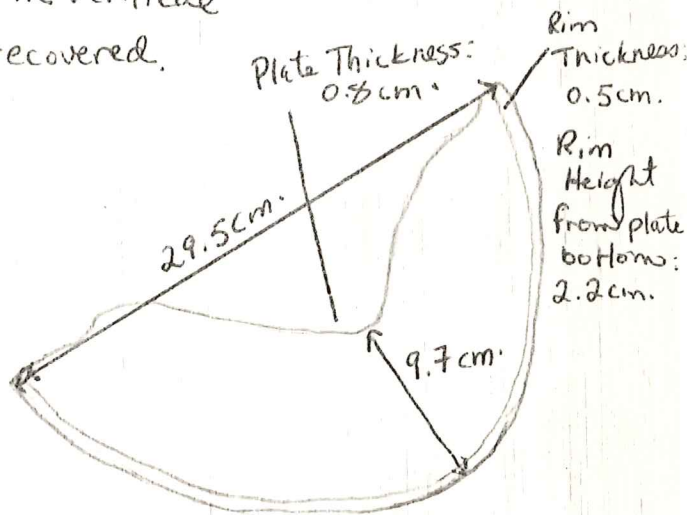
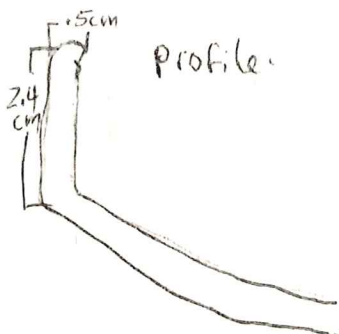

(drawing not to scale)

TEXAS

Date: 5 June 1981

No. PZ-81-169T-

Object: Loom Weights of Terracotta ABCDE

Square: K-1 Batt 17A

Photograph:

Rock Concentrations

Level: and Below

Drawing:

Dimensions: L.,

H.,

W.,

Th.,

Technique:

Condition: All are encrusted and scratched.

Description: (from PZ-81-167PK)

A -

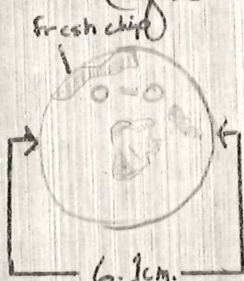

Munsell: 5YR 7/4 (Pink)

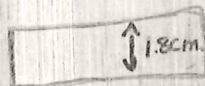

Round loom weight with a irreg. depress. ?stamp? in center. Stamp is illegible.

There is a depression in the back of the loom weight running from the holes to the far edge from them + could have been made by a finger.

B -

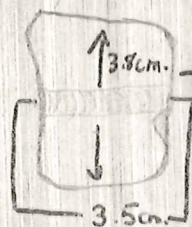
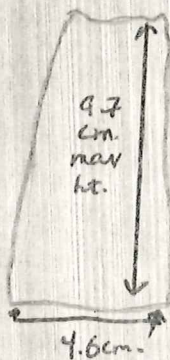

Pyramidal Loom Weight. Top was broken, at the point where hole went through, in antiquity.

Munsell: 5YR 6/6 (Reddish Yellow) Does not join to 228T

C -

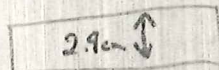
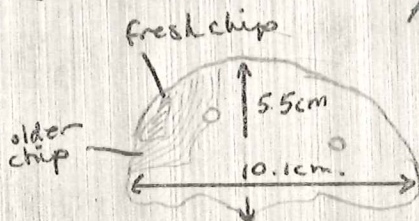

Almost half of round loom weight Munsell: 2.5YR 6/8 (light red)

TEXAS

Date: 5 June 1981

No. PZ-81-169 T (cont'd)

Object: loom weights of Terracotta: A, B, C, D, E

Square: K-11 Batt 7A
Rock Conc. +

Photograph:

Level: Below

Drawing:

Dimensions: L.,

H.,

W.,

Th.,

Technique:

Condition:

Description:

D-

old break →

2.1 cm.

fresh chip →

7.5 cm.

6.5 cm.

Round loom weight - a bit more than one quarter of it - Heavily encrusted. No stamp preserved. Large chip absent from back.

Munsell: 2.5YR 6/8 (light red)

E.

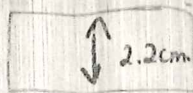
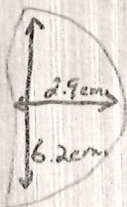

Round loom weight. No holes; no stamp preserved.

Munsell: 5YR 8/3 (pink).

Drawings not to scale!

TEXAS

Date: 5 June 1981

No. PZ-81-1705-AB, C, D, E

Object: 1 mortar or grinding stone frag
4 other rocks of debatable function

Material: Stone

Square: KL1 Batt. 174
Tile + Rock Conc.

Photograph:

Level: Below

Drawing:

Dimensions: L., H., W., Th.

Technique:

Condition:

Description:

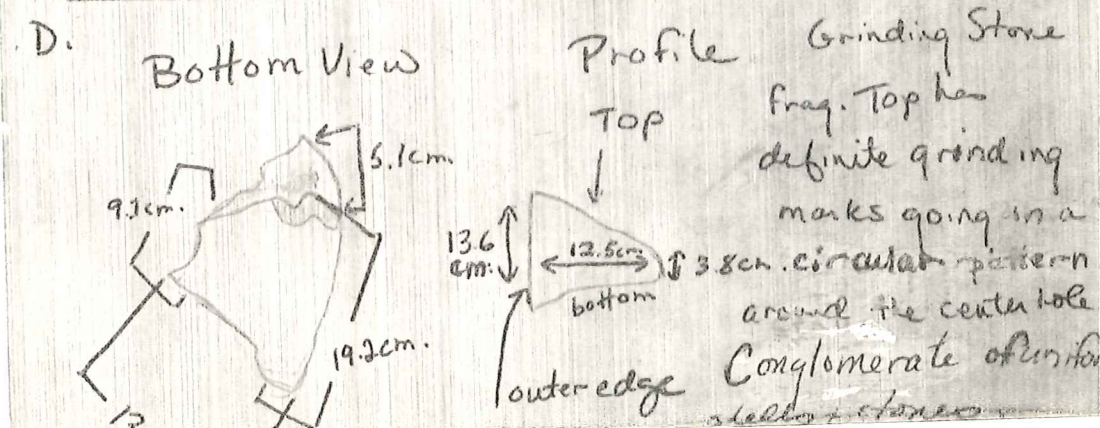
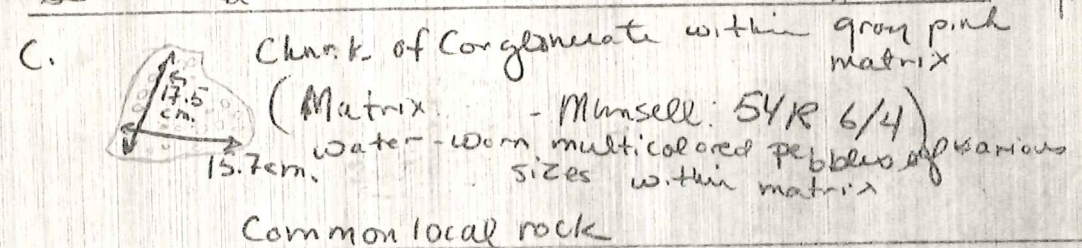
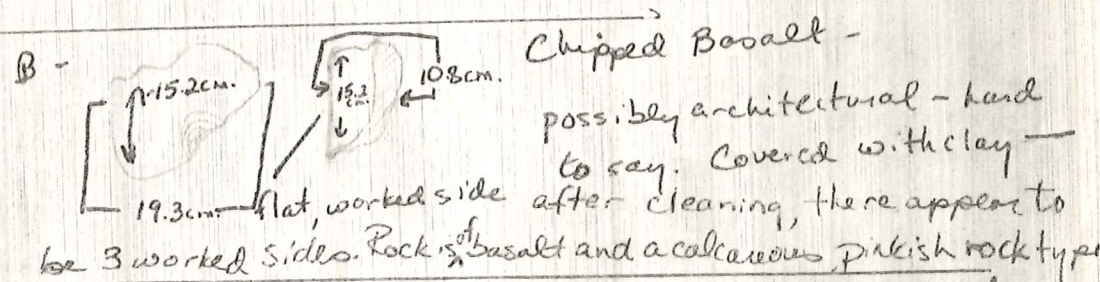
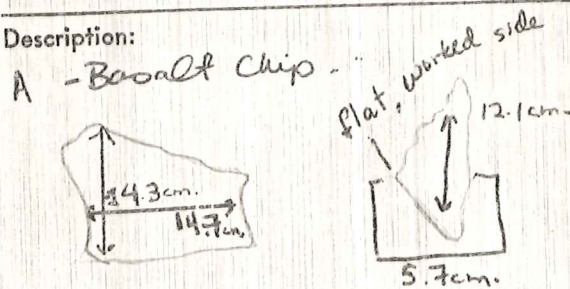

TEXAS

Date: 5 June 1981

No. PZ -81-1705 A,B,C,DE (cont'd)

Object: 2 mortar or grouting stone frag. to the rocks of debatable function Material: Stone

Square: K¹-1 Batt. 17A Photograph:

T. & Rock Conc. +

Level: Below Drawing:

Dimensions: L., H., W., Th.,

Technique:

Condition:

Description: Limestone?

E -

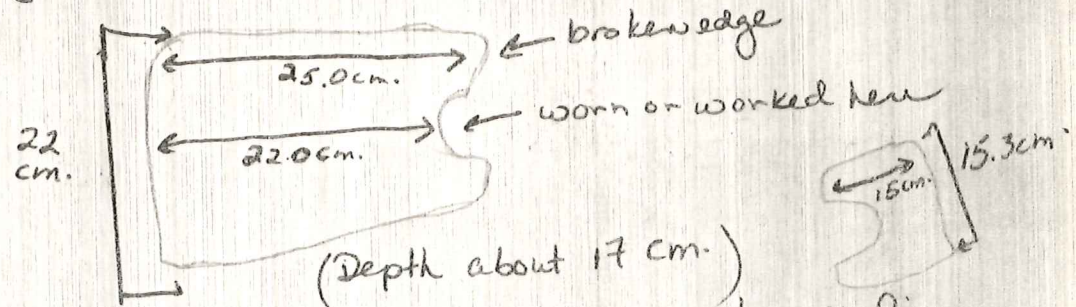

This block has deep scratches in it revealing a white, grainy type of rock under the clay covering it.

TEXAS

Date: 5 June 1981

No. PE -81 -171 ~~WS~~

Object: ^{Water} Sep. Sample - Charcoal lens Material: Charcoal

Square: K1-1 Batt. 16A Photograph:

Charcoal lens 2.4m.
Level: N of S. end of Trench Drawing:

Dimensions: L., H., W., Th.,

Technique:

Condition: Very Crumbly

Description: Small Amount

TEXAS

Date: 5 June 1981

No. PZ-81 - 172B

Object: Bones

Material: Bone

Square: K¹⁻¹ Batt. 16A

Photograph:

Tile Conc. is Gray

Level: Clay

Drawing:

Dimensions: L.,

H.,

W.,

Th.,

Technique:

Condition:

Description:

TEXAS

Date: 8 June 1981

No. PZ-81-173 SS

Object: Small Chunk of Ground Brick ^(in matrix) Material: Cement?

Square: wear Trench
cleaning level

Photograph:

Level: Batt. 2

Drawing:

Dimensions: L.,

H.,

W.,

Th.,

Technique:

Condition: Crumbly

Description:

(from PZ-81-182 BL)

Small (approx 6.5cm x 3cm) chunk of a crumbly grainy substance. There appear to be tiny broken bits of tile or pottery in it. The matrix is fine and white.

TEXAS

Date: 5 June 1981

No. PZ - 81 - 174B

Object: Bone

Material: Bone

Square: K'-1 Box. 17A

Photograph:

SW Corners in

Level: Tik Conc.

Drawing:

Dimensions: L.,

H.,

W.,

Th.,

Technique:

Condition:

Description:

TEXAS

Date: 5 June 1981

No. PE-81-175 WS

Object: Water Sep. Sample

Material: Varied

Square: K-1 Batt. 161

Photograph:

Tile Conc.

Level:

Drawing:

Dimensions: L.,

H.,

W.,

Th.,

Technique:

Condition:

Description:

TEXAS

Date: 5 June 1981

No. PZ .81 -176M

Object: Slag

Material: Slag.

Square: k' - 1 Bott. 17A

Photograph:

Tile + Rock

Level: Conc.

Drawing:

Dimensions: L.,

H.,

W.,

Th.,

Technique:

Condition: Crumbly

Description:

One large chunk + many small ones

TEXAS

Date: 5 June 1981

No. PZ - 81 - 177SS

Object: Burnt Sample

Material: Charcoal

Square: K1-1 Batt. 17A

Photograph:

Tile + Rock

Level: Conc.

Drawing:

Dimensions: L.,

H.,

W.,

Th.,

Technique:

Condition:

Description:

TEXAS

Date: 5 June 1981

No. 72 - 81 - 178M

Object: Slag

Material: Slag

Square: K1-1 Batt. 17A
T. let Rock Conc. +

Photograph:

Level: Below

Drawing:

Dimensions: L.,

H.,

W.,

Th.,

Technique:

Condition: Crumbly

Description: Several Chunks

TEXAS

Date: 5 June 1981

No. PZ-81-179B

Object: Bone

Material: Bone

Square: K'-1 Benth. 17A

Photograph:

Tile Conc.

Drawing:

Level:

Dimensions: L.,

H.,

W.,

Th.,

Technique:

Condition:

Description:

TEXAS

Date: 5 June 1981

No. 72 - 81 - 1808

Object: Bone

Material: Bone

Square: K1-1 Batt. 17A
Tile + Rock Conc. +

Photograph:

Level: Below

Drawing:

Dimensions: L.,

H.,

W.,

Th.,

Technique:

Condition:

Description:

TEXAS

Date: 5 June 1981

No. PZ- 81- 181B₃

Object: Bone

Material: Bone

Square: K'-1 Batt. 17A

Photograph:

Tile + Rock Conc.

Level:

Drawing:

Dimensions: L.,

H.,

W.,

Th.,

Technique:

Condition:

Description:

TEXAS

Date: 8 June 1981

No. 72-81-183B

M1-55M-8 →

Object: Bone

Material: Bone

Square: Well Trench

Photograph:

Cleaning level

Level: Batt. 2

Drawing:

Dimensions: L.,

H.,

W.,

Th.,

Technique:

Condition:

Description:

TEXAS

Date: 8 June 1981

No. PZ-81-184B₅

Object: Shell

Material: Calcite or Aragonite

Square: Weel Trench
Balk n¹-54

Photograph:

Level:

Drawing:

Dimensions: L.,

H.,

W.,

Th.,

Technique:

Condition:

Description:

TEXAS

Date: 8-VI-81

No. Pz-81-186 B

Object: Bones

Material: Bone

Square: N-5+
Well Trench Balk

Photograph:

Level:

Drawing:

Dimensions: L.,

H.,

W.,

Th.,

Technique:

Condition:

Description:

TEXAS

Date: 8-VI-81

No. PZ-81-187 T

Object: 34 votive plaque fragments Material: Terracotta

Square: N'-5
Well trench Bulk

Photograph:

Level:

Drawing:

Dimensions: L.,

H.,

W.,

Th.,

Technique:

Condition: Encrusted and worn - fragmentary

Description:

34 Votive plaque fragments. Two seem to be the top of heads - The largest fragment is a base (A) with 2 feet possibly 3. The base is a corner piece. max preserved height 4.0 cm max preserved width 8.9 cm thickness at base 0.5 cm munsell 5YR 7/8.

Since all the pieces come from different plaques no munsell will be given.

TEXAS

Date: 8-VI-81

No. PE-81-188 M

Object: Slag

Material: slag

Square: N¹-5 +
Well trench Balk

Photograph:

Level:

Drawing:

Dimensions: L.,

H.,

W.,

Th.,

Technique:

Condition:

Description:

one piece of slag

TEXAS

Date: 8-VI-81

No. Pz-81-189 P

Object: Red figure Pottery fragments (2) Material: Pottery

Square: Well Trench
Balk - lower 1/2

Photograph:

Level: N¹-5

Drawing:

Dimensions: L.,

H.,

W.,

Th.,

Technique:

Condition: Good

Description:

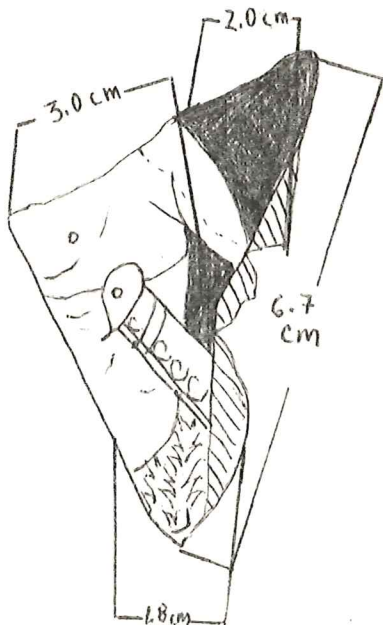

Red figure pottery sherd composed of two fragments. The most visible decoration is a torso with upper left arm. Figure seems to be holding a scabbard which is seen on the right side of the sherd. Because of the fur which surrounds the torso in the lower right corner, this could possibly be a centaur.

Drawing to Scale.

Sherd .65cm thick

MUNSELL 5YR-7/6 reddish yellow

TEXAS

Date: 8 June 1981

No. PE-81-190T

Object: 22 frags. votive terracotta Material: Terracotta

Square: W 333 Trench

Photograph:

Back
7'-5+

Level:

Drawing:

Dimensions: L.,

H.,

W.,

Th.,

Technique:

Condition: worn, encrusted, fragmentary

Description: (from PE-81-181)

22 fragments of terracotta. They are difficult to understand and are all small.

TEXAS

Date: 8-VI-81

No. PZ-81-191 M

Object: Coin?

Material: BRONZE

Square: Well Trench
S. Balk N¹-5 +
Lower 1/2
Level:

Photograph:

Drawing:

Dimensions: L.,

H.,

W.,

Th.,

Technique:

Condition: rusted (poo) and mounted.

Description:

Small circular bronze disc

diameter c. 1.7 cms

thickness (average) 0.4 cms.

No discernible design on either face.

TEXAS

Date: 8-VI-81

No. P2-81-192 B5

Object: Shell

Material: aragonite

Square: Well Trench
S. Barks N1-5+

Photograph:

Level:

Drawing:

Dimensions: L.,

H.,

W.,

Th.,

Technique:

Condition: good condition

Description:

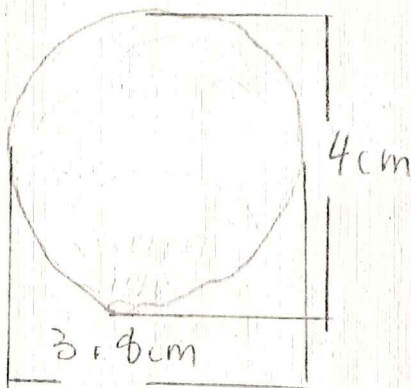

drawing to scale

TEXAS

Date: 9-VI-81

No. Pz-81-193T

Object: 39 votive plaque fragments Material: Terracotta

Square: Well Trench
S. Balk N1-S t

Photograph:

Level:

Drawing:

Dimensions: L.,

H.,

W.,

Th.,

Technique:

Condition: good but encrusted

Description: From #Pz-81-191 PL also see Pz-81-249T

39 votive plaque fragments. On several pieces, faces can be seen. One is extremely well preserved. also a piece of plaque showing reclining figure holding on a chalice.

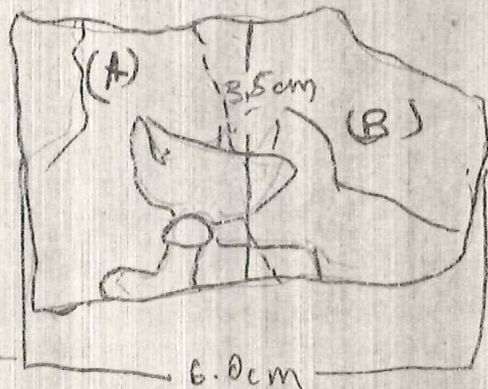

C)

approx. thickness. 0.4cm

Munsell 5YR 7/6 reddish yellow

approx thickness 0.4cm

Munsell

left half (A) 5YR 7/4 reddish yell.

right half (B) 5YR 7/6 reddish yell.

TEXAS

Date: 3 June 1981

No. PZ-81 - 19455

Object: Charcoal lens in Gray Brown Soil. Material: Varied - Charcoal

Square: K-1 Batt. 14A | Photograph:

NE Quad.

Level: in gray brown | Drawing:

Dimensions: L., H., W., Th.,

Technique:

Condition:

Description:

TEXAS

Date: 9 June 1981

No. PZ - 81 - 19555

Object: Soil Sample

Material: Varied

Square: Well Trench

Photograph:

Well Cleaning

Level: w/ in a top block
w/ U slope

Drawing:

Dimensions: L.,

H.,

W.,

Th.,

Technique:

Condition:

Description:

TEXAS

Date: 9-VI-81

No. PZ-81-196T

Object: 36 votive plaque fragments Material: Terracotta

Square: Well Trench
S. Balk N¹-6

Photograph:

Level:

Drawing:

Dimensions: L.,

H.,

W.,

Th.,

Technique:

Condition: fragmentary-encrusted.

Description: From # PZ-81-205 PL

36 votive plaque fragments, 3 of which are faces. The best preserved^(A) is of Munsell 5YR 7/8 reddish yellow.

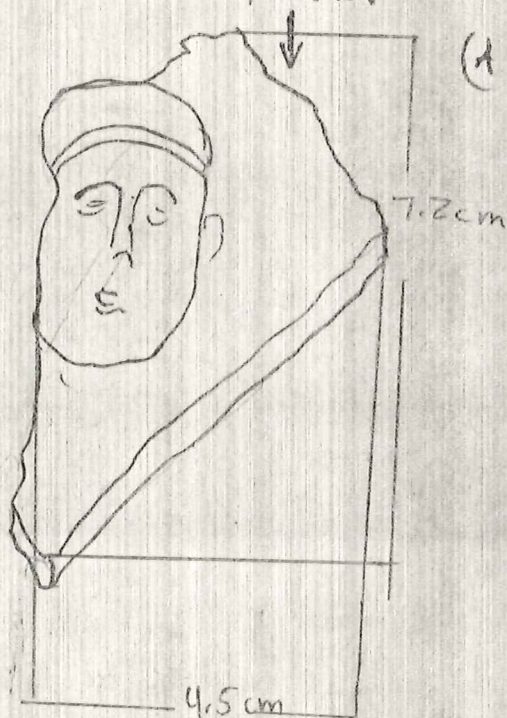

approx. thickness 0.5 cm.

3

TEXAS

Date: 9-VI-81

No. PZ-81-1983

Object: 1 piece of ^{MILLING STONE} Calcarenita di Gravina Material: Calcarenita di Gravina

Square: Well Trench
S-Balk N1-5+

Photograph:

Level:

Drawing:

Dimensions: L.,

H.,

W.,

Th.,

Technique:

Condition:

Description: From PZ-81-197 PL

One piece of calcarenita di gravina (a local building stone). Stone was probably used for milling.

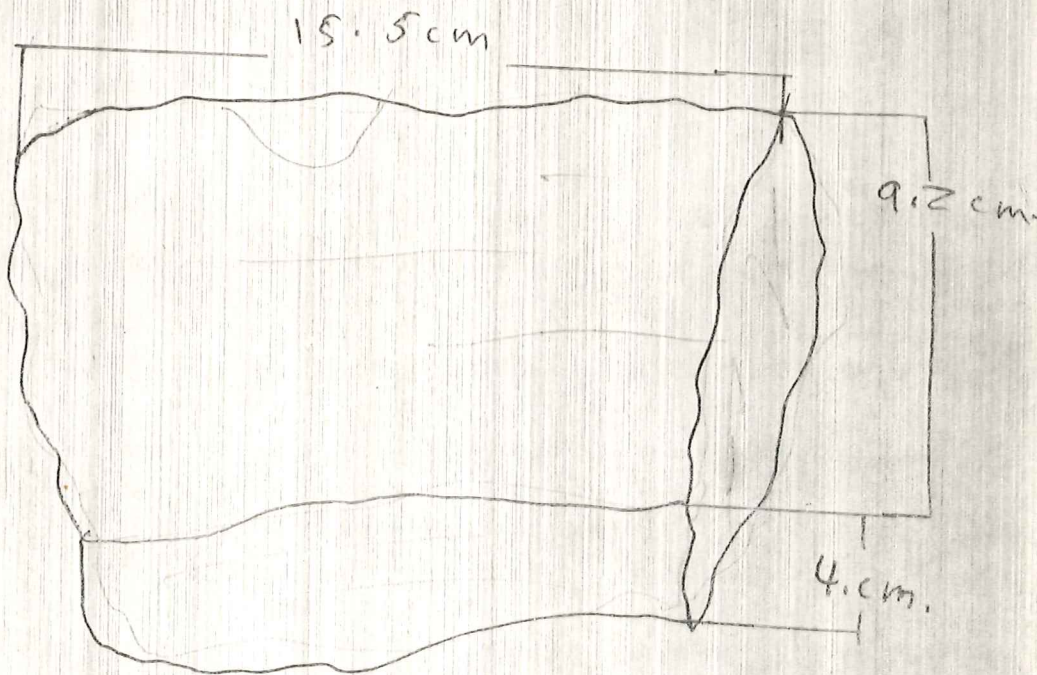

Munsell 10 YR 8/1 white

TEXAS

Date: 4 June 1981

No. PZ-81 - 200T

Object: Roof Tile Frag. (Not Special) Material: Tena Cotta

Square: K1-1 Bath. 16A

Photograph:

Gr. - Br. to Tile +

Level: Rock Conc.

Drawing:

Dimensions: L.,

H.,

W.,

Th., Max. point on rim
2.1cm.

Technique:

Condition: Fragmentary

Description: (from PZ-81-144PL)

Munsel: 5YR 7/4 (pink)

incised band decor

8.7 cm.

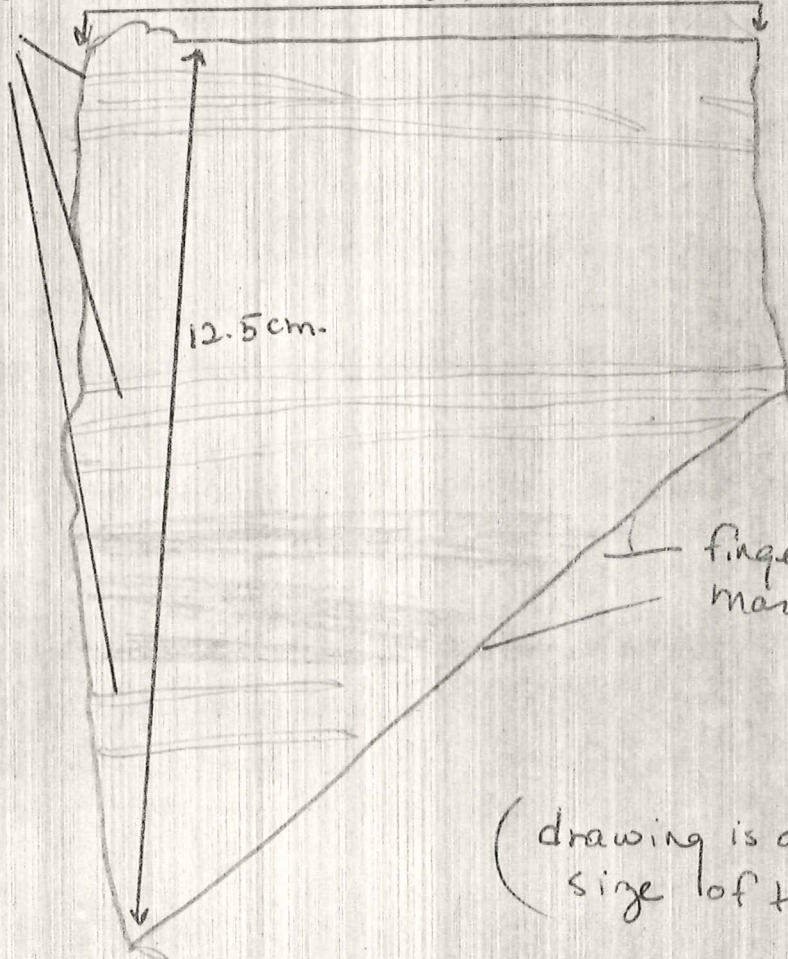

finger marks

(drawing is actual size of tile)

TEXAS

Date: 9 June 1981

No. PZ-81-201B

Object: BONES

Material: Bone

Square: Well Trench
S. Balk N¹-5+

Photograph:

Level:

Drawing:

Dimensions: L.,

H.,

W.,

Th.,

Technique:

Condition:

Description:

Bos taurus:

- 1. Left tibia - proximal end.
- 3. Ilium Frag.
- 2. Right 1st phalanx
- 4. Right ulna - shaft frag

Ovis/Capra/Capreolus

- 6. Metacarpus - shaft frag

Sus scrofa

- 8. Lower incisor

UnId large

- 5. Right ulna - articular surface.
- 11. Proximal rib frag
- 14. Pelvis frag.

Medium UnId

- 7. Unid long bone frag - jawed
- 10. Right humerus shaft frag
- 12. Rib frag
- 16. Tibia(?) shaft frag.

Medium Large UnId

- 13. Femur? proximal frag - juvenile

Medium Small UnId

- 9. Left tibia shaft.

UnId 15 F . . .

TEXAS

Date: 9 June 1981

No. PZ-81-202B

Object: Shell

Material: aragonite
or calcite

Square: Well trench
S. Balk n'-6

Photograph:

Level:

Drawing:

Dimensions: L.,

H.,

W.,

Th.,

Technique:

Condition:

Description:

KAS

Date: 9 June 1981

No. PZ-81-204B

Object: Bone

Material: Bone

Square: Front Digging
Drainage Ditch

Photograph:

Level:

Drawing:

Dimensions: L.,

H.,

W.,

Th.,

Technique:

Condition:

Description: (from PZ-81-203PK)

TEXAS

Date: 9 June 1981

No. PZ -81 -206B

Object: Bone

Material: Bone

Square: Well Trench

Photograph:

S. Balk
Level: N'-6+

Drawing:

Dimensions: L.,

H.,

W.,

Th.,

Technique:

Condition:

Description:

(from PZ -81 -205PL)

TEXAS

Date: 9-VI-81

No. PZ-81-208T

Object: loom wt. w/ crescent shaped depression. Material: Terracotta

Square: Well Trench
S. Balk n1-6t

Photograph:

Level:

Drawing:

Dimensions: L.,

H.,

W.,

Th.,

Technique:

Condition: scratched and chipped.

Description:

From # PZ-81-207 PC

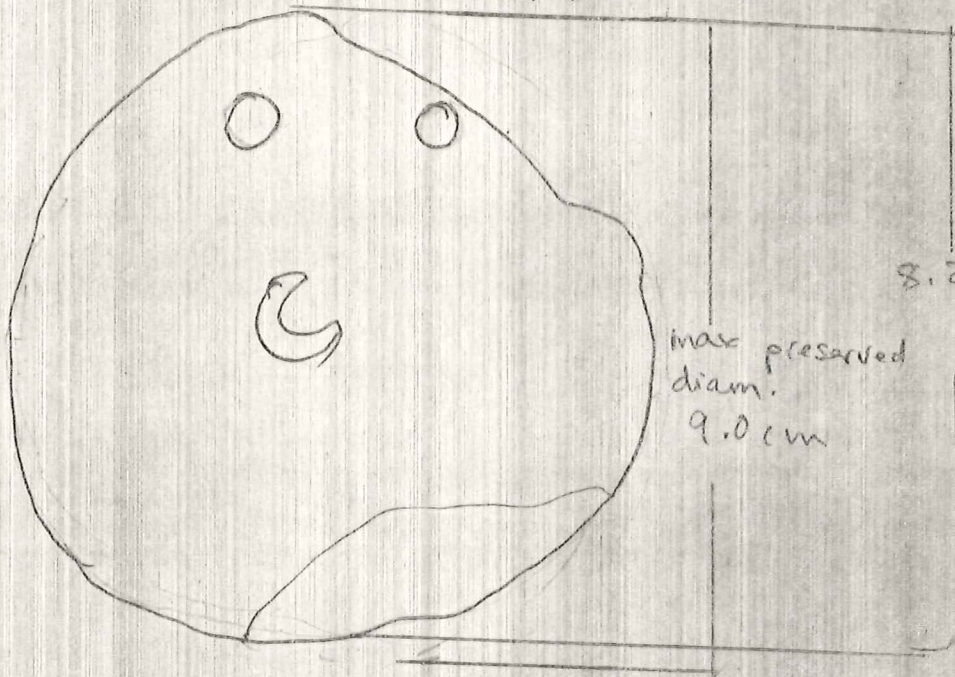

One round loom wt.
 2.7cm munsell 2.5YR 6/6
 1 light red. wt. is
 very chipped.

TEXAS

Date: 9 June 1981

No. PZ-81-209B

Object: Bone

Material: Bone

Square: Well Trench

Photograph:

S. Balk N'-6+

Level:

Drawing:

Dimensions: L.,

H.,

W.,

Th.,

Technique:

Condition:

Description:

Bos taurus

2. Anterior right first phalanx.
8. Right P^{IV} Young Adult

Sus scrofa

1. mandibular symphysis
7. Upper incisor.

Cervus elaphus

3. Left radius - proximal end
- 4 " " "

Equus caballus

5. Left metacarpus II

Ovis/Capra/Capreolus

6. Right acetabulum frag.

Small Uⁿ Id

9. Rib - head and part of shaft

Medium Uⁿ Id

10. Thoracic vertebra - frag of neural spine.

Large Uⁿ Id

11. Uⁿ Id long base frag

TEXAS

Date: 9 June 1981

No. PE-81-211B

Object: Bones

Material: Bone

Square: Well
Trench -

Photograph:

Level: Well

Drawing:

Dimensions: L.,

H.,

W.,

Th.,

Technique:

Condition:

Description:

TEXAS

Date: 9 June 1981

No. PZ - 81 - 212M

Object: Piece of Fibula ?

Square: Well Trench

Material: Iron?

Photograph:

Level: Well

Drawing:

Dimensions: L.,

H.,

W.,

Th.,

Technique:

Condition: Poor - Corroded, granular coating

Description: (from PZ - 81 - 210PK)

Back of this piece
has a rectangular
protrusion - probably
the clasp.

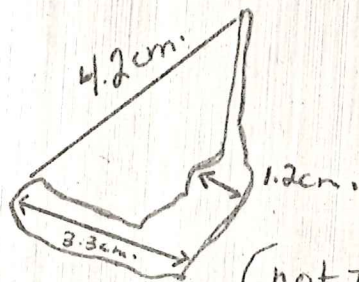

(not to scale)

Front

after restoration:

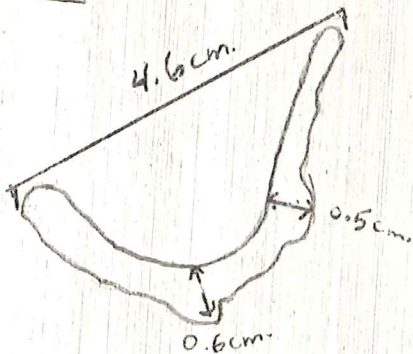

TEXAS

Date: 8 June 1981

No. PZ-81-213T

Object: 14 frags of votive plaques Material: Tenacotta

Square: Well Trench

Photograph:

Cleaning level

Level: Batt 1

Drawing:

Dimensions: L.,

H.,

W.,

Th.,

Technique:

Condition: Worn + Encrusted

Description: 14 fragments (from PZ-81-182 PL)

Munsell: 5YR 7/4 (pink)

TEXAS

Date: 10 July 1991

No. PZ - 81 - 2155

Object: Fragment of grinding stone? Material: Basalt

Square: Well trench
S. Balk, 71'-76'

Photograph:

Level: W'-9

Drawing:

Dimensions: L., H., 7.4cm., W., Th.,

Technique:

Condition: Fragment.

Description: (from PZ - 81 - 21412)

This cataloguer does not find any grinder-marks on this stone.

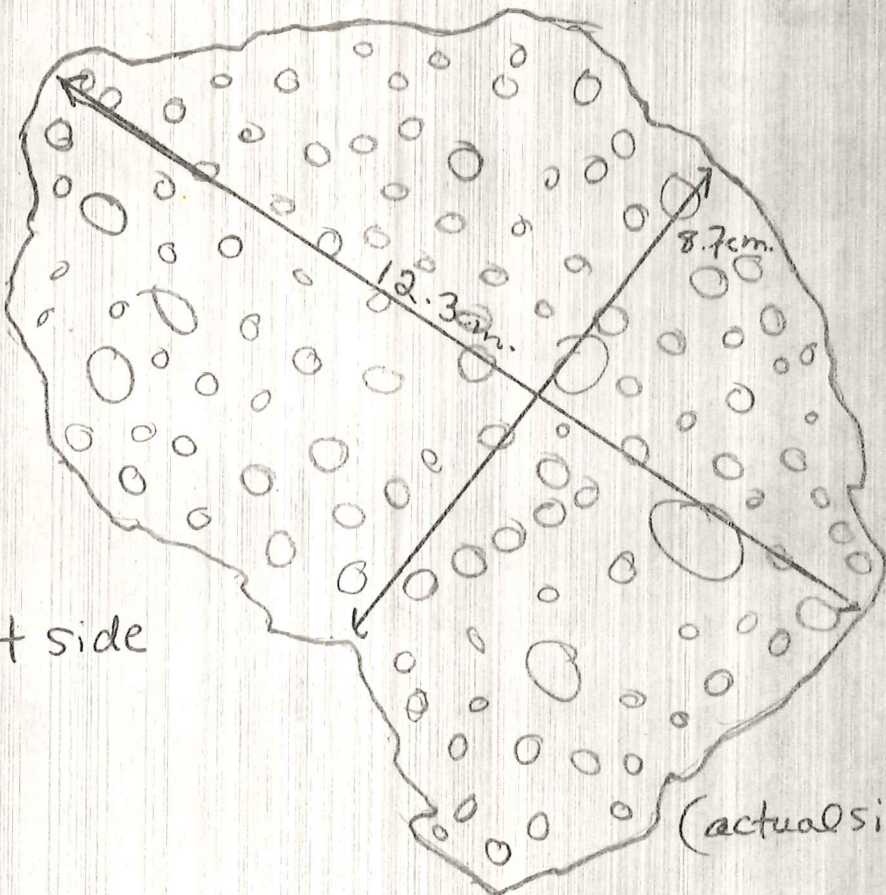

TEXAS

Date: 10-VI-81

No. PZ-81-218 M

Object: SLag

Material: SLAg

Square: J¹-1/K¹-1
Balt 17A NW quad

Photograph:

Level:

Drawing:

Dimensions: L.,

H.,

W.,

Th.,

Technique:

Condition: fragments encrusted

Description:

from # PZ-81-217 PL

8 pieces of slag - 3 large and
5 small

TEXAS

Date: 10-VI-81

No. Pz-81-2195

Object: Basalt

Material: Basalt

Square: JLI/KI-1
Bath 17A NW quad

Photograph:

Level:

Drawing:

Dimensions: L.,

H.,

W.,

Th.,

Technique:

Condition:

Description: From # Pz-81-217 PL

3 pieces of Basalt: one large and two
small
Munsell 10YR 5/1 gray

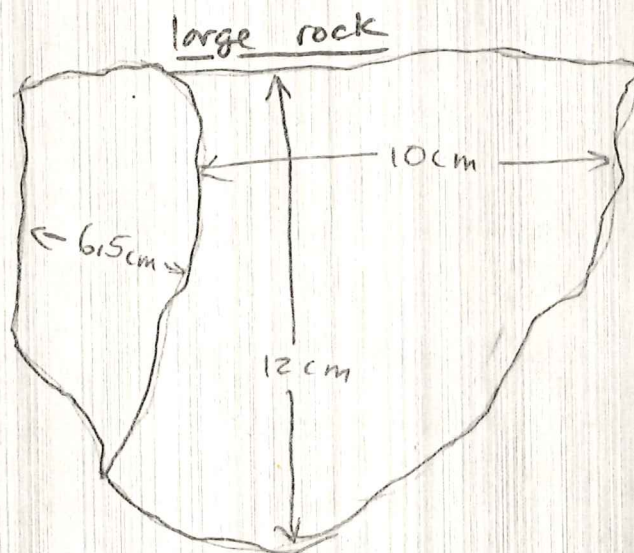

large stone is possibly ^{the} outside of a milling
stone.

TEXAS

Date: 10-VI-81

No. PZ-81-220A

Object: Cook ware (fragment) ^{rim + body} Material: Pottery

Square: J1-1/K1-1
Batt, 17A NW Quad

Photograph:

Level:

Drawing:

Dimensions: L.,

H.,

W.,

Th. of rim:
0.8cm.
of body:
0.8cm.

Technique:

Condition: fair - encrusted

Description: From # PZ-81-217 PL

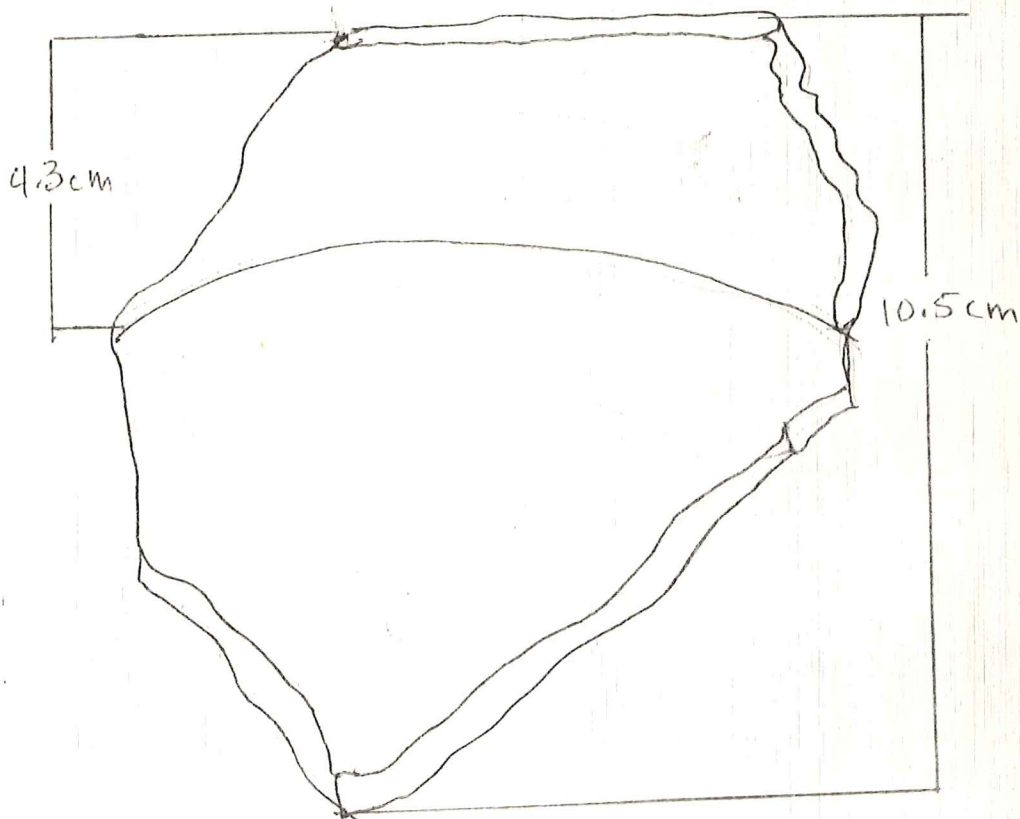

One fragment of shallow cookware dish.

Munsell 2.5YR 6/6 light red.

Darker red glaze on interior is chipped and worn. Munsell 8/10 R 5/8 (red).

TEXAS

Date: 10-VI-81

No. PZ-81-222 P

Object: Stamped rim of amphora

Material: Pottery

Square: K1-1 Batt 18C
Dark Gray to Virgin

Photograph:

Level:

Drawing:

Dimensions: L.,

H.,

W.,

Th.,

Technique:

Condition: weathered.

Description: from # PZ-81-221PL

Stamped rim of coarse ware storage vessel. fragment very worn down. Stamp seems to have two "A's" and two other identical letters.

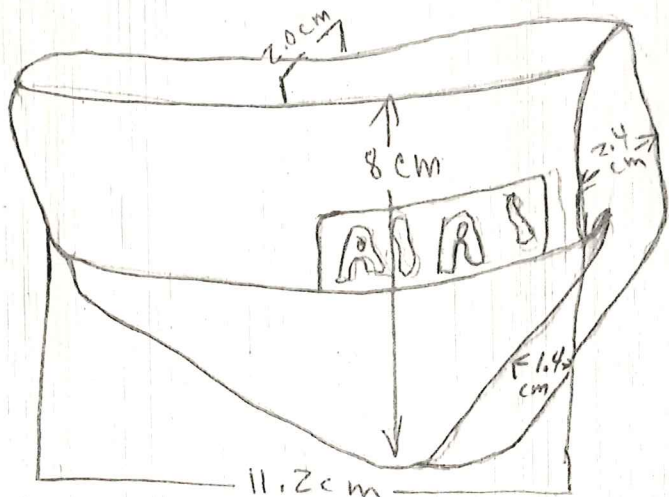

Munsell 10YR 8/3 very pale brown

TEXAS

Date: 10-VI-81

No. Pz-81-223 P

(rim, body, handle - coarse ware)
Object: top of handled storage jug

Material: Pottery

Square: K-H B&H 18C
Dark Gray-Brown to
Vign. Dk. Gray
Level:

Photograph:

Drawing:

Dimensions: L.,

H.,

W.,

Th., of rim:

2.6 cm.

Technique:

of body:

Condition: good.

1.1 cm.

Description: From # Pz-81-221 PL

Top of storage jug in 9 pieces. Jug made of coarse ware approx. 1 cm thick. Handle attached to lip of vessel and to belly where a band of two incised lines circle the jug. Munsell 7.5YR 8/4 pink.

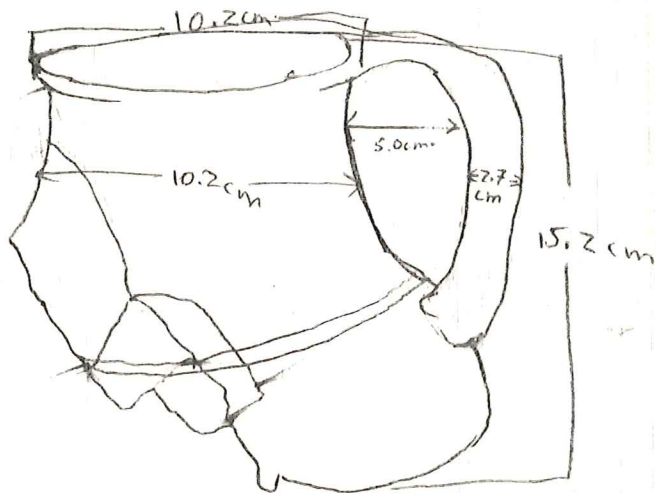

TEXAS

Date: 10-VI-81

No. PZ-81-224 T

Object: loom wt

Material: Terracotta

Square: K¹-1 Batt 18C

Photograph:

Dark gray - brown to
virgin dark gray
Level:

Drawing:

Dimensions: L.,

H.,

W.,

Th.,

Technique:

Condition: good - one large chip

Description: From # PZ-81-221 PL

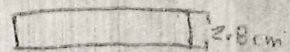
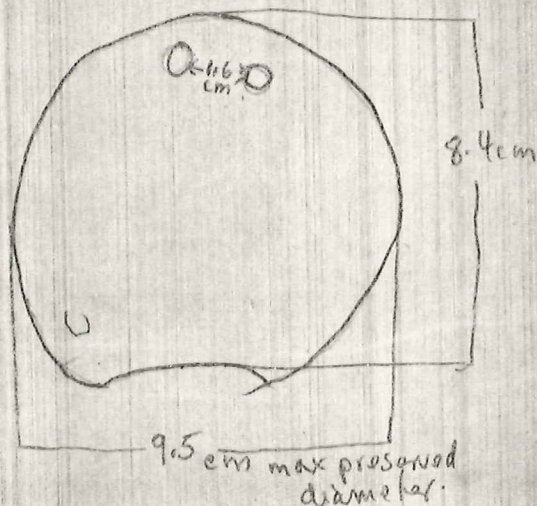

One large loom wt.
in fairly good condition -
bottom of wt. chipped.

Munsell 5YR 7/6
reddish yellow

loom wt. not stamped.

TEXAS

Date: 10-VI-81

No. PZ-81-225P

Object: Pottery amphora in 50 pieces Material: Pottery

Square: K1-1 Batt 18C
Dirt-gray to Virgin

Photograph:

Level:

Drawing:

Dimensions: L., H., 19.2cm. W., Th., of handle:

Technique: Diameter of Mouth 11.0cm.
Diameter of base 7.4cm.

1.1cm.
of rim:
0.5cm.

Condition: fragmented but in good state of preservation

Description: From Pottery lot PZ-81-221 PL

50 amphora pottery pieces of munsell 5YR 7/6 reddish yellow. At place where neck meets belly of vessel, two lines circles the vase - approx. thickness of vessel wall is .5cm -

After Conservation - Table amphora is nearly complete; missing only about half of the rim, and one handle, and a few body sherds. The handle

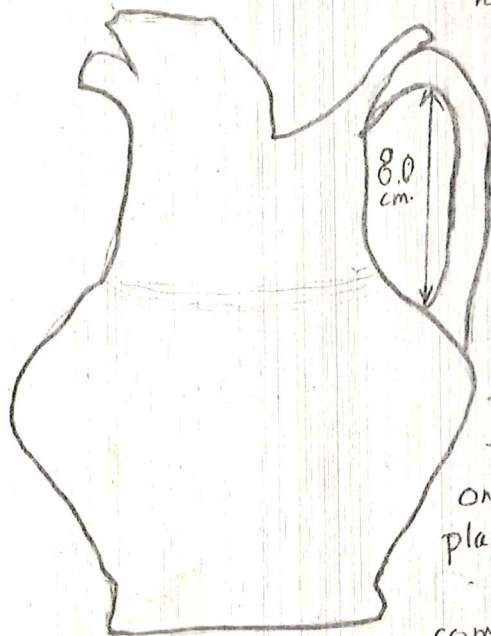

has a raised center ridge running the length of it.

The neck is wide in relation to the belly. The rim is widely flaring and does not project far away from the neck.

One handle frag. is placed with the pot although it does not come from it.

TEXAS

Date:

9 June 1981

No. PZ-81-227T

Object: 18 fragments votive plaque Material: Terracotta

Square: Well Trench Photograph:

S. Balk

Level: N1-5+

Drawing:

Dimensions: L.,

H.,

W.,

Th. max.
preserved.
1.1cm.

Technique:

Condition: Fragmentary, encrusted, worn.

Description:

18 fragments - undecipherable for this catalogue. All are small.

A) - Munsell: 5YR 7/6 Reddish Yellow.

approx thickness
0.6 cm

from
(PZ-81-199PL)

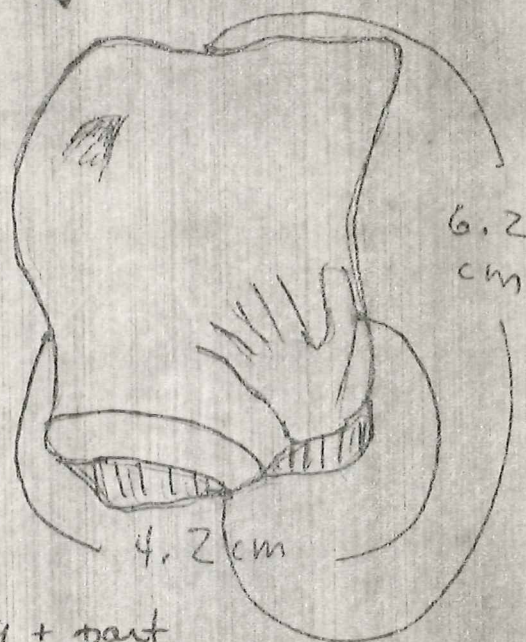

B) - Frag. - Satyr's leg + part
of lionskin drape

Munsell:

Max. ht. 6.0cm

TEXAS

Date: 10 June 1981

No. PZ-81-228T

Object: Loom Weight Frag. (Pyramidal) Material: Terracotta

Square: Well Trench
S. Balk N. 7to

Photograph:

Level: A1-9

Drawing:

Dimensions: L., H., 1.9cm. W., Th.,

Technique: (Max. Preserved Ht.)

Condition: Fragment - encrusted and worn

Description: (from PZ-81-214 PL)

Does not join to 16T

Munsell: 5YR 7/4 Pink

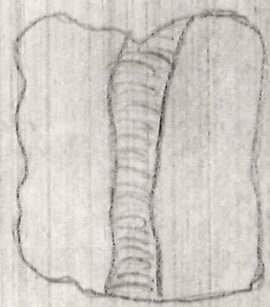

Bottom view

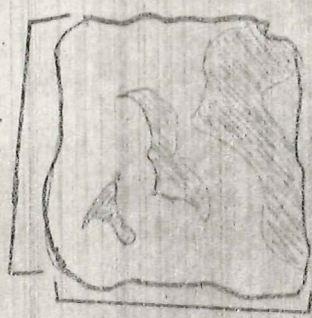

Top view
(shaded areas are old chips)

3.5 cm.

3.3 cm.

Max. height 2.1cm.

TEXAS

Date:

5-VI-81

No.

PE-81-229 5

Object: Architectural Fragment?

Material:

Calcarenita di
Gravina

Square: K-1 Ball, 17A

Photograph:

Tile + Rock Coins.

Level:

Drawing:

Dimensions: L.,

H.,

W.,

Th.,

Technique:

Condition: Good - edges broken off on at least 3s. side

Description: This piece is noteworthy because of the
carved, raised section on one side

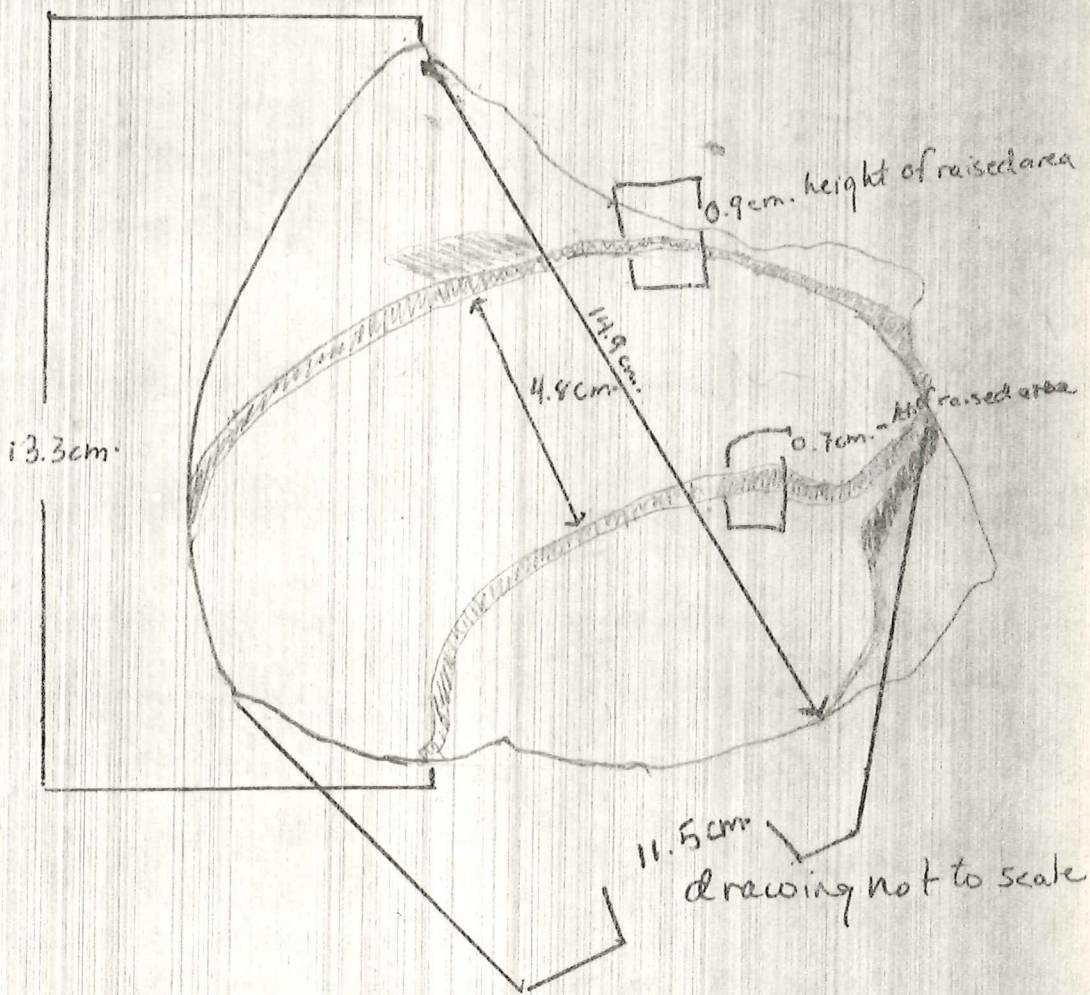

TEXAS

Date: 9-VI-81

No. PZ-81-230 T

Object: 17^{FRAGS} Votive Terracottas Material: Terracotta

Square: Well Trench
S. Balk N1-6T

Photograph:

Level:

Drawing:

Dimensions: L., H., W., Th.,

Technique:

Condition: weathered and worn.

Description: 17 Terracotta fragments. (PZ-81-207 PL)
on One fragment, a satyr's hoof is recognizable

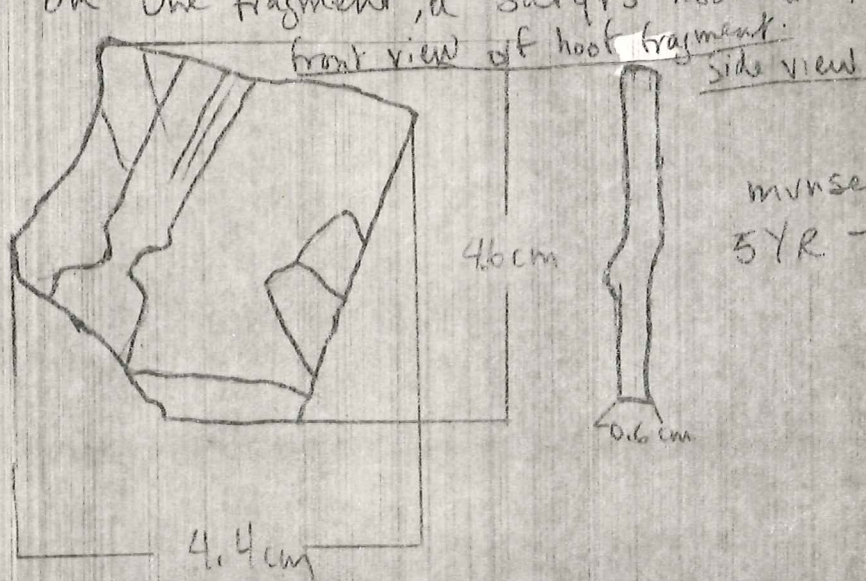

TEXAS

Date: 9-VI-81

No. PZ-81-231 M

Object: BRONZE FIBULA

Material: BRONZE

Square: Well Trench
S. Baks - lower 1/2
around N-7
Level:

Photograph:

Drawing:

Dimensions: L.,

H.,

W.,

Th.,

Technique:

Condition: rusted but not very decayed.

Description:

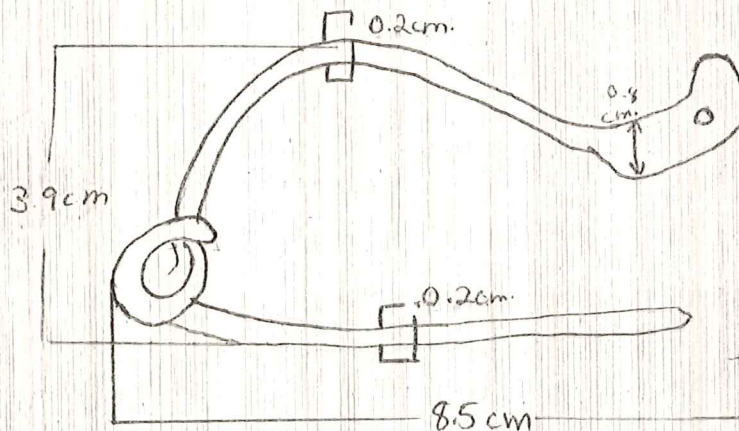

approximate
size

Very well preserved bronze fibula. Object seems to have been made in one piece. On back of clasp, the catch still remains.

TEXAS

Date: 5-VI-81

No. PZ-81-232P

Object: BOWL - unglazed fineware

Material: POTTERY

Square: K1-1 BATT 17A

Photograph:

Til and Rock Concen.

Level:

Drawing:

Dimensions: L., H., W., Th.,

Technique: 12 cm max preserved diameter.
diameter of base: 5.8 cm.

Condition: worn down

Description: (PZ-81-162PL)

Table ware bowl in 10 pieces.
Shape of bowl almost complete. On the interior,
wheel ridges can be seen. Outside
is smooth with several incized lines.

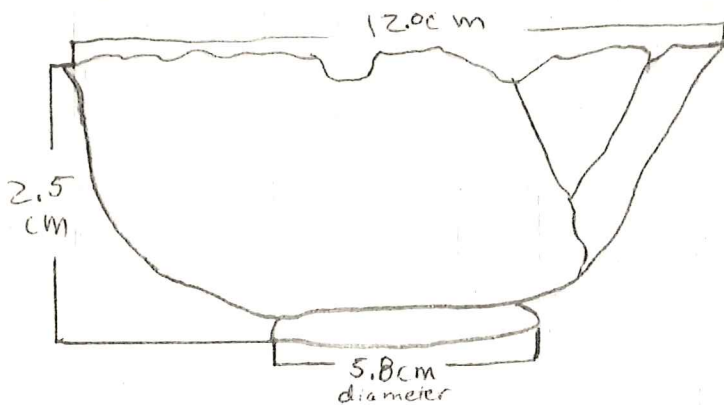

interior munsell 5YR 7/3 pink
exterior munsell 7.5YR 8/6 reddish yellow

After Restoration: Bowl is in 3 parts: 1 body sherd, not joining with others, 1 section near rim comprising 4 sherds, and the main portion, comprising 5 sherds. This portion is the portion drawn above.

TEXAS

Date: 9-VI-81

No. P2-81-233M

Object: 1 U.S. Penny

Material: Copper

Square: well Trench
well

Photograph:

Level:

Drawing:

Dimensions: L.,

H.,

W.,

Th.,

Technique:

Condition: encrusted

Description:

One U.S. 1977 penny

TEXAS

Date: 9 June 1981

No. PE-81-234 P-AB

Object: 2 portions of Ionic Cups

Material: Pottery

Square: Well Trench
S. Balk 71-5

Photograph:

Level:

Drawing:

Dimensions: L.,

H.,

W.,

Th.,

Technique:

Condition: Incomplete A - 3 frags B - 4 frags
all join all join

Description: Slip + decoration are in good states of preservation

A - Munsell inside-rim 5YR 7/6 (reddish yellow).
Outside: same color Glaze: outside 5YR 3/R Dark
Reddish Brown.

Exterior decoration - one painted
stripe on edge of rim
one wide stripe on shoulder.
Unpainted strip runs below
shoulder stripe: it is 1.7cm
wide. Remainder of this recovered
portion of the pot was
painted black. Interior
decoration. Unpainted strip at top of rim, rest of rim
and interior painted black.

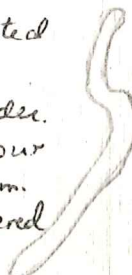

- profile.

Max preserved Th.:
0.4cm.

Max preserved Ht.:
4.6cm.

Estimated Diameter at lip: 15.4cm.

B - Munsell inside rim - 5YR 7/6 (pink) Outside is
same color. Glaze exterior: 5YR 3/1 (very dark gray).

Exterior decoration - one
painted stripe on edge of rim.
2 stripes painted on shoulder.
Below shoulder, black slip is
solid.
Interior: edge of rim - one
stripe, one strip below
it is unpainted, and
rest of rim and
interior of pot are

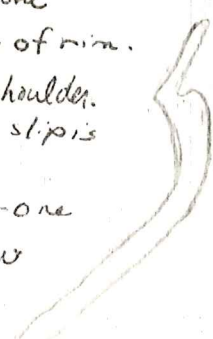

- profile

Max. Preserved Th. 0.4cm.

Max. Preserved Ht.
6.8cm.

TEXAS

Date: 10-VI-81

No. Pz-81-235T

Object: roof tile - 2 Edges ?End tile? Material: Terracotta

Square: KL-1 Batt 18C
Dark Gray to Virgin

Photograph:

Level:

Drawing:

Dimensions: L.,

H.,

W.,

Th.,

Technique:

Condition: chipped and encrusted.

Description: From # Pz-81-221 PL

1 fragment of Terracotta roof tile with 2 preserved edges - On top edge, we can see an incized line; side edge is rounded. Munsell top of tile: 7.5 YR 7/6 reddish yellow - side of tile - munsell 5YR 6/8 reddish yellow -

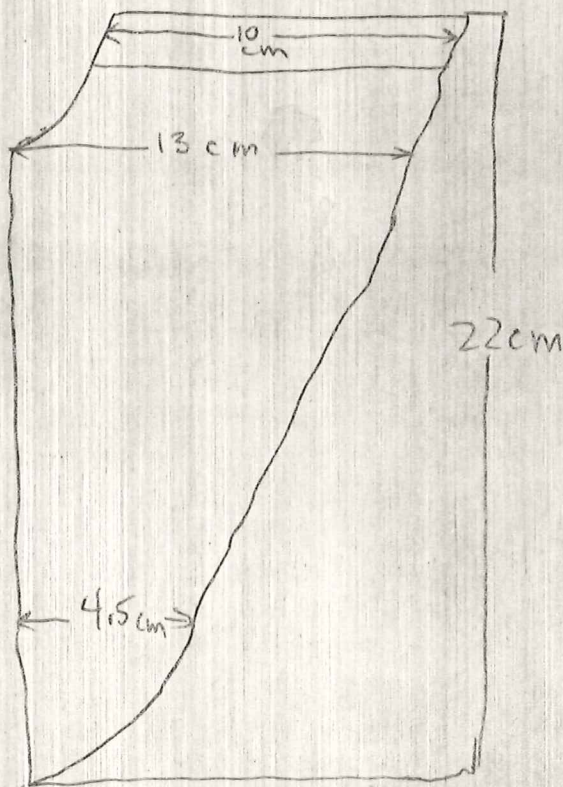

tile is 1.8 cm thick.

TEXAS

Date: 10-VI-81

No. PZ-81-236B

Object: Bone

Material: Bone

Square: K1-1. BaH.17A
Dark gr-Br. clay

Photograph:

Level:

Drawing:

Dimensions: L.,

H.,

W.,

Th.,

Technique:

Condition:

Description:

TEXAS

Date: 10-VI-81

No. PZ-81-237B

Object: Bones

Material: Bone

Square: Well trench
S. Balk N'-7 to N'-9

Photograph:

Level:

Drawing:

Dimensions: L.,

H.,

W.,

Th.,

Technique:

Condition:

Description:

Equus caballus:

- 1 Right Posterior 1st Phalanx
- 2 Right metatarsus - appears to articulate with # 1
- 3. Right radius - distal end
- 4. " " " " Cut marks?
- 10 Left astragalus
- 11 Left os naviculare - appears to articulate with # 10
- 12 Right radius - proximal frag
- 13 Right radius - shaft.
- 16 Metatarsal II Right - appears to articulate with # 2.
- 19 MB left.

Bos taurus:

- 5 Right tibia - distal end
- 6 Anterior outer right 1st phalanx - cut marks
- 7 Right calcaneus - juvenile?
- 14 Axis - Anterior frag.
- 15 Frontal frag + base of horn core. dehorned
- 18. Left tibia - proximal end.
- 21. Lumbar vertebra

Ovis aries:

- 17 Left radius proximal end.
- ? 20 Left humerus - distal frag.

Ovis / Capra

- 22 M³, M² Right with bits of mandible - 2 parts
- 23 M² or ³ Left

Cervus elaphus

- 8. Right femur - distal end.
- 9. Left mandible frag with M³ M¹ P⁴ Cut marks

Un Id. Large

- 24 Un Id long bone shaft frag
- 25 " "

TEXAS

Date: 10-VI-81

No. PZ-81-238 B

Object: BONES

Material: Bone

Square: Well Hensch
S. Balk N¹-7 to
N¹-9
Level:

Photograph:

Drawing:

Dimensions: L.,

H.,

W.,

Th.,

Technique:

Condition:

Description:

Bos taurus

- 2. Cranial frag with base of horn core - dehorned.
- 3. ? Cervical vertebra frag.

Sus scrofa

- 1. Right calcaneum frag - juvenile gnawed.

• Ovis/Capra/Capreolus

- 5. Right M² with bit of attached mandible.

Med. U. Id.

- 6. Mandible - ventral frag.
- 7. Mandible frag.
- 8. 11 u. id. frags.

Large U. Id

- 4. Rib - shaft + frag.
- 9. " "
- 10. Vertebra(?) frag - cut mark
- 11. 26 u. id. frags

TEXAS

Date: 10-VI-81

No. PZ-81-239 B

Object: Bones

Material: Bone

Square: Well trench
Well
to water level

Photograph:

Level:

Drawing:

Dimensions: L.,

H.,

W.,

Th.,

Technique:

Condition:

Description:

TEXAS

Date: 10-VI-81

No. PZ-81-290 B

Object: Bones

Material: Bone

Square: K-1 Batt 18C
OK - Gray Br. to Virgin

Photograph:

Level:

Drawing:

Dimensions: L.,

H.,

W.,

Th.,

Technique:

Condition:

Description:

Bos taurus;

- 3. Left scapula - articular region.
- 4 Right humerus - distal portion
- 5 Right acetabulum frag.
- 6. "
- 7 Cervical vertebra frag.

Capra hircus

- 1 Horn core

Sus scrofa

- 2 Right humerus - distal end.

Homo sapiens

- 11 6 cranial frags - probably part of PZ-81-241B-12

Cervus elaphus?

- 10. upper molar frag.

Large UnId

- 12 " unid frags

UnId

- 13 28 unid frags many probably from 3.

TEXAS

Date: 10-VI-81

No. PZ-81-241 B

Object: BONES

Material: Bone

Square: J1-K1
Belt 17A NW quad

Photograph:

Level:

Drawing:

Dimensions: L.,

H.,

W.,

Th.,

Technique:

Condition:

Description:

Bos taurus:

- 1 Right radius - distal end.
- 2 " proximal end
- 3 Left metatarsal shaft - gnawed.
- 4 " proximal end.
- 5. Left Astragalus Frag.
- 14 Right humerus Frag.
- 19? Distal tibia Frag.

Bos brachyceros?

- 6 Metapodial - distal frag.

Sus scrofa

- 7. Left tibia distal end - cut marks
- 8 Right maxilla w/ P1 M2 and newly erupted M3 and left maxilla w/ M2 and M1 2 pieces. Probably domesticus
- 12. Dorsal cranial Frag.

Homo sapiens

- 9. Maxilla Frag with Right P2 and P3 Old individual
- 10. Cranial Frag - very thick.

Cervus elaphus

- 11 Axis - Antero-ventral frag.

Equus caballus ?

- 13 Articulation of left mandible

Large UnId:

- 15 metapodial shaft frag

Medium UnId - 6 unid frags.

TEXAS

Date: 8 June 1981

No. PZ-81-242P

Object: Fragment SHALLOW BOWL w/ SPOUT Material: Pottery

Square: Well trench

Photograph:

S. ball N¹-5+

Drawing:

Level:

Dimensions: L.,

H.,

W.,

Th. of rim.

Technique:

1.7 cm.

Condition: Fragment ENCRUSTED. Slip is worn.

of body:

1.7 cm.

Description:

(from PZ-81-185 PL)

Semi-fine ware. Munsell: 5YR 7/6

Rim and portion of spout of a shallow dish.

One orange band is painted inside the rim and around the inside curve near the spout.

Paint: Munsell 2.5YR 5.8

A disc of clay is applied beside the rim.

Max thickness: 1.2 cm.

inner diameter of spout 2.1 cm

thickness of spout 1.0 cm

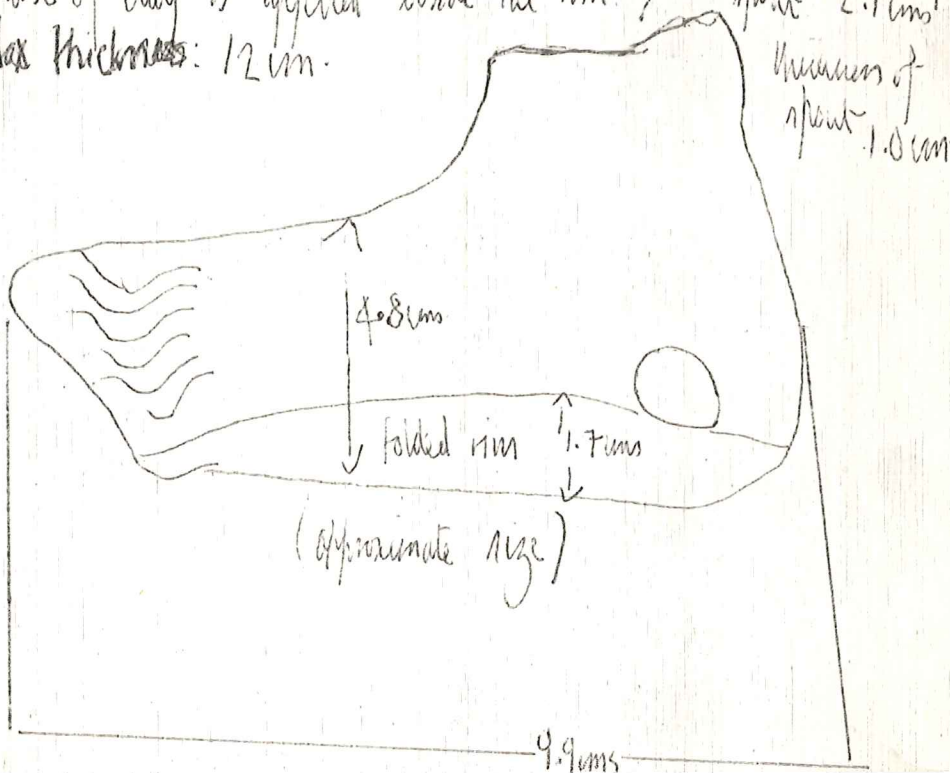

TEXAS

Date: 10-11-81

No. PZ-81-243B

Object: Bones

Material: Bone

Square: out of

Photograph:

Context

pala ~~musculina~~

Drawing:

Level: necdenica

Dimensions: L.,

H.,

W.,

Th.,

Technique:

Condition:

Description:

TEXAS

Date: 11 June 1981

No. PZ-81-245M

Object: Nail

Material: Metal - Iron

Square: K'-1/J'-1 Balto
Ramp Sect. A 13-17A

Photograph:

Level:

Drawing:

Dimensions: L.,

H., 5.6 cm.

W.,

Th.,

Technique:

(max preserved)
Diam. of head - 2.2 cm. Diam. of shaft - 1.2 cm.

Condition:

Corroded and Encrusted - Poor

Description:

(from PZ-81-257P2).

Worn, corroded, bent nail.

TEXAS

Date: 11 June 1981

No. PZ-81-246P

Object: ^{Rim, handle + body} Coarse, thin ware amphora ^{* + 19 body sherds} Material: Pottery

Square: K'-1/J'-1
Camp Sect. A
Baths 13-17A

Photograph:

Level:

Drawing:

Dimensions: L.,

H. 2.1 cm

W.,

Th. of rim 2.6 cm

Technique:

max. preserved height.

of body 2.5 cm

Condition: Fragmentary and worn, and encrusted

Description:

(from PZ-81-251PK)

19 body sherds are bagged with this rim, body + handle section of a small coarse ware amphora

One body sherd is from PZ-81-262PK.

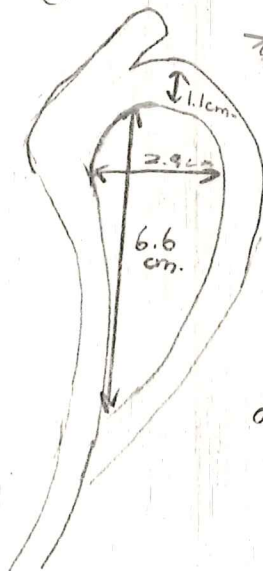

* = Cook Jar

drawing not to scale

The fabric is Munsell 2.5YR 6/6 light red w/ salt-grain sized white inclusions.

TEXAS

Date: 11, June 1981

No. PZ - 81 - 247 T A+B

Object: 2 Loom Wts. ^{Biconical} _{Pyramidal} Material: Terracotta

Square: 5¹-1, Butt. 13B Photograph:

E Side Dk-Brown

Level: Lt. Gray Mottled Drawing:

Dimensions: L., H., W., Th.

Technique:

Condition: Fair - both are scratched + encrusted B- is well worn.

Description:

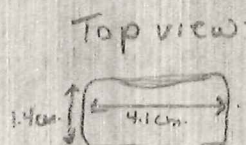
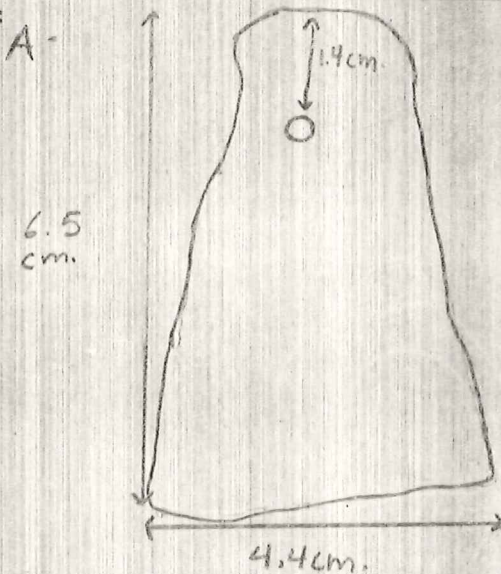

Munsell: 2.5YR 6/6
light red

B.

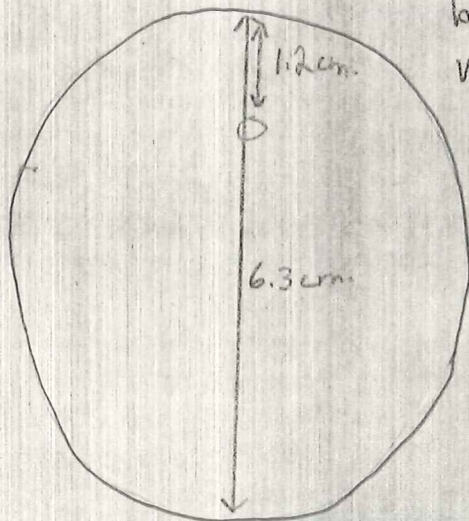

biconical loom wt
Munsell 7.5YR
8/2 pinkish yellow



TEXAS

Date: 11 June 1981

No. PZ-81-248 PA+B

Object: Gray Ware-Chalice? Funnel?? Material: Pottery

Square: J-1, Batt. 138

Photograph:

E. side - Dk. Brown

Level: Grayish / Lt. Gray
Mottled

Drawing:

Dimensions: L.,

H.,

W.,

Th., Rim: 0.7cm.

Technique: Max. preserved ht.

Body: 0.9cm.

Condition: Interior diameter of spout: 5.3cm.

Description: Condition: Fair encrusted and worn.

A)

(from PZ-81-244 PH)

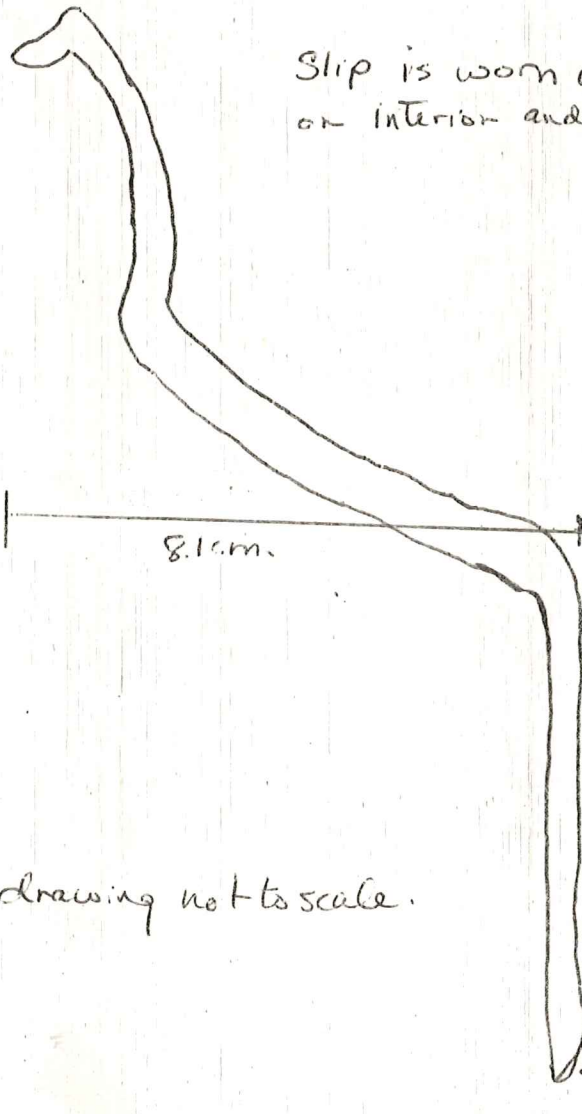

Slip is worn almost completely off on interior and exterior.

drawing not to scale.

finished edge

TEXAS

Date: 11 June 1981

No. PZ-81-248P-A+B (cont'd)

Object: Gray Ware - Chalice - ? Funnel ?? Material: Pottery

Square: J-1, Batt. 13B

Photograph:

E. Side - Dk. Brown

Grayish / Lt. Gray
Level / Mottled

Drawing:

Dimensions: L.,

H.,

W.,

Th.,

Technique:

Condition: Fair - encrusted + worn.

Description: B) does not join to A, but is same shape. This portion of the vessel comprises 7 frags. One frag. came from PZ-81-255 PL, and the others are from PZ-80-248P.

TEXAS

Date: 9-VI-81

No. PZ-81-249 T

Object: Terracotta votive plaque fragments Material: Terracotta

Square: Well Trench
S-Bulk N-3T

Photograph:

Level:

Drawing:

Dimensions: L.,

H.,

W.,

Th.,

Technique:

Condition: fair - weathered - fragmentary

reared

Description: From PZ-81-193 T

approx thickness
is 0.5 cm
munsell-

5YR
7/4

6 Fragments of votive plaque
the largest is composed of
7 fragments - head at bottom of
large fragment is
a menad from
satyr menad plaque.
although they do not fit
to large frag, the remaining
5 pieces ^{seen} have the
same characteristics
and have been put
with large frag. one of
the small frags. is a
part of a
satyr's
head.

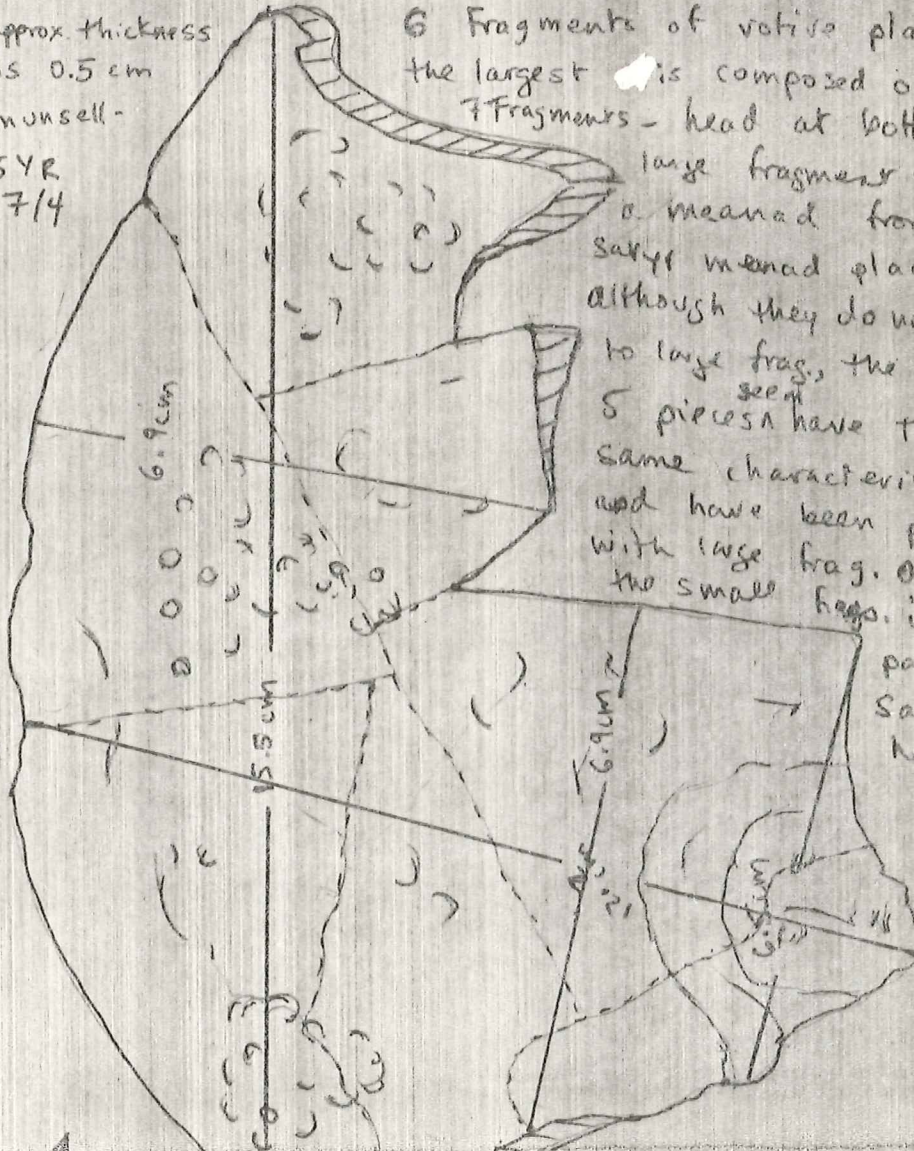

TEXAS

Date: 11 June 1981

No. PZ 81-252B

Object: Bone

Material: Bone

Square: Ramp Sect. A
K'-1/JI-1

Photograph:

Level: Batt. 13-17A

Drawing:

Dimensions: L.,

H.,

W.,

Th.,

Technique:

Condition:

Description:

(from PZ-81-251PT)

Bag 1

Ovis/Capra

2. Upper left molar (M₁ or M₂)

Large UnID

1. Mandible frag

UnID - 2 unid frags.

Bag 2

Bos taurus

3. Right Femur distal end - gnawed

4. Left Femur - shaft.

9. Right mandible - 9 frags - edentulous.

Equus caballus

1. Anterior 2nd phalanx - proximal end

2. Metatarsus IV Right.

TEXAS

Date: 11 June 1981

No. PZ-81-254P

Object: Rim + base of shallow burned ^{dish - coarseware} Material: Pottery

Square: ^{J-1 Sect. B} Ramp N. End
Ash Deposit + Under and
Level: Ceramic Deposit.

Photograph:

Drawing:

Dimensions: L., H., 5.9cm. W., Th., of Rim 0.9cm.
of base 0.9cm.

Technique: Max. Preserved Diam. of base 5.6cm.
Estimated Diam. of base: 32cm.

Condition: Fragmentary - Fair - paint is worn, vessel is slightly
an eroded

Description: (from) # PZ-81-290 PL

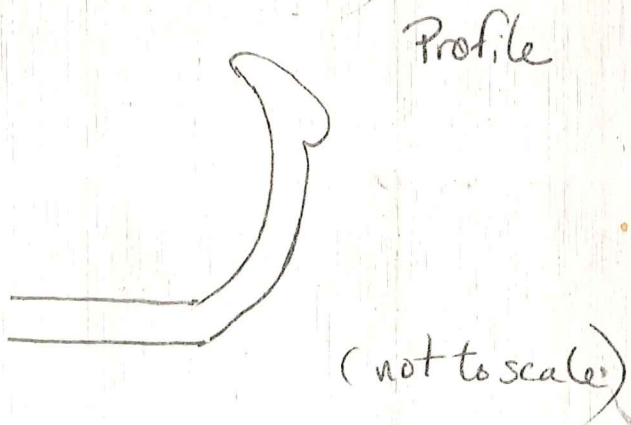

Very large shallow dish. Paint was applied over all of rim, exterior, and seems to have been applied over the entire interior. Preserved section comprises 7 sherds. There are burned spots over the interior and exterior of this vessel. The fabric is slightly gritty coarse ware.

* Does not join to PZ-81-315P

Munsell: interior - 5YR 7/6 (reddish yellow)
orange glaze - 2.5YR 5/6 (red)

TEXAS

Date: 11 June 1981

No. PZ-81-256B

Object: Bones

Material: Bone

Square: J'-1/K'-1
Batt. 18C Dk. Gray
Level: ^{To} Virgin

Photograph:

Drawing:

Dimensions: L.,

H.,

W.,

Th.,

Technique:

Condition:

Description:

Bos taurus

1. Left Frag - distal Frag.
- 3 Left edentulous mandible Frag
2. Mandible Frag - probably part of 3
4. ? Small Frag of horn core.

TEXAS

Date: 11 June 1981

No. PZ-81-257P

Object: Unglazed Unguentarium

Material: Pottery

Square: K'-1/J'-1
Sect. A Ramp

Photograph:

Level:

Drawing:

Dimensions: L.,

H.,

9.1 cm.

W.,

Th.,

Technique:

Condition: part of neck, and of base missing

Description:

miniature unglazed unguentarium with
long slender neck and slightly flaring foot.

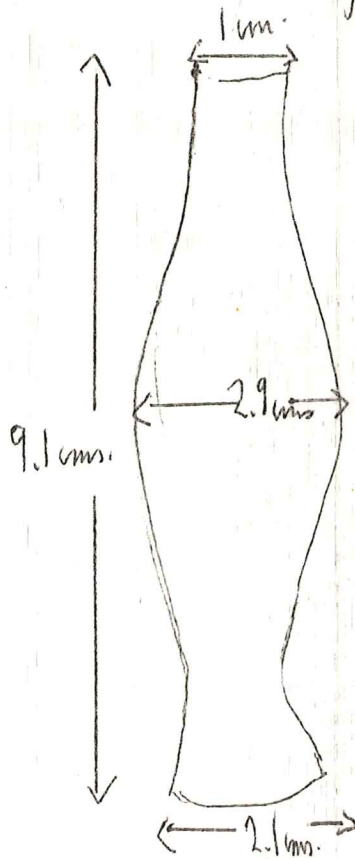

Munsell 5YR 7/4
pink.

no decoration.

TEXAS

Date: 11 June 1981

No. PZ-81-258 P

Object: Complete Profile of Gray Ware Bowl Material: Pottery

Square: K¹-1/J¹-1
Sect. A Ramp

Photograph:

Level:

Drawing:

Dimensions: L.,

H. (max. preserved) W.,

Th.,

Technique:

10.1 cm.

Condition:

est. diam. at rim : 14.6 cm

Description:

Fragment - Fair - encrusted, glaze very worn on exterior
(PZ-81-254 PL)

Deep bowl with incised stipple marks on exterior.
Stippling covers all of exterior except for a wide
band below the rim. The band is 3.1 cm wide

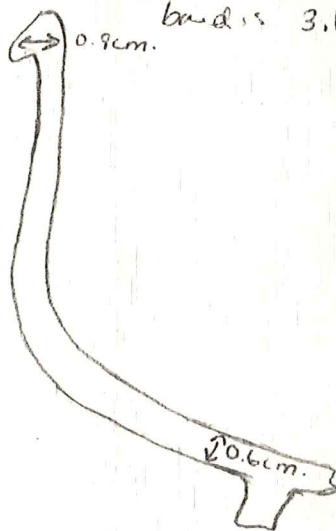

TEXAS

Date: 11, June 1981

No. PZ-81-259T

Object: 1 loom wt. (Round)

Material: Terracotta

Square: K1-1/J1-1
Sect. A Ramp

Photograph:

Level:

Drawing:

Dimensions: L.,

H.,

W.,

Th., 2.2cm.

Technique: Diameter - 7.7cm.

Condition: Fair - chipped, scratched, encrusted

Description: (from PZ-81-254PH)

Round loom weight has no stamp

Munsell: 5YR 7/6 (reddish yellow).

TEXAS

Date: 11 June 1981

No. PZ-81-260M

Object: Metal Slag

Material: Slag

Square: K'-1/J'-1
Sect. A Ramp

Photograph:

Level:

Drawing:

Dimensions: L.,

H.,

W.,

Th.,

Technique:

Condition:

Description:

TEXAS

Date: 11 June 1981

No. 92-81 - 261B

Object: Bone

Material: Bones

Square: J¹-1 Batt. 138
Dk. Brown-Glayish^{SP}

Photograph:

Level: Lt. Gray Mottled

Drawing:

Dimensions: L.,

H.,

W.,

Th.,

Technique:

Condition:

Description:

TEXAS

Date: 11 June 1981

No. PE-81-263P

Object: ^{UNGUENTARIUM} ~~Amphallos~~ - all but rim, orange glaze ^{interior} Material: Pottery

Square: J'-1 Batt. 18C

Photograph:

DE Gray Brown

Drawing:

Level: to Virgin

Dimensions: L., H., 10.7cm. (max. preserved) W., at widest part of body: 3.3cm. Th., 0.24t weh.

Technique: Diam. of foot (base) - 1.0cm

Condition: Fair - exterior encrusted, interior glaze worn

Description: (from PE 81-262Pd)

the foot or base is broken off unevenly ^{therefore there is} no certainty of the shape of the base. There are very small traces of glaze left at various points on the exterior.

Interior glaze is evenly preserved.

3.1cm

Munsell: 5YR 7/6 (reddish yellow)

interior glaze: 5YR 5/8 (yellowish red).

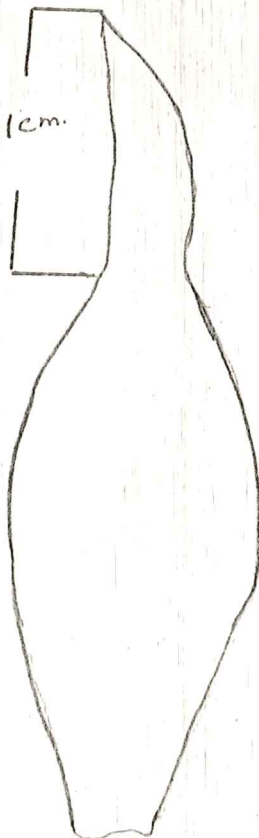

TEXAS

Date: 10-VI-81

No. PZ-81-264^PA,B,C

Object: 3 red figure body fragments Material: Pottery

Square: Palaeoethnica

Photograph:

Out of Context

Level:

Drawing:

Dimensions: L.,

H.,

W.,

Th.,

Technique:

Condition: fair.

Description:

Drawings to scale

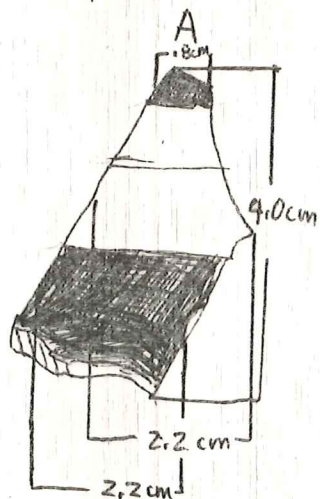

Munsell 5YR 7/4 pink
Thickness 0.55 cm

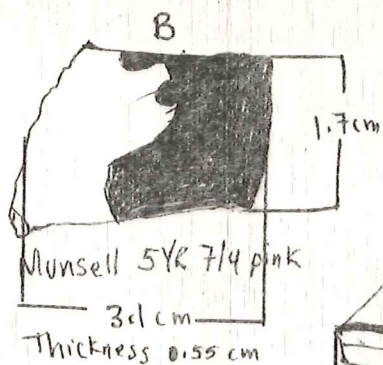

Munsell 5YR 7/4 pink
Thickness 0.55 cm

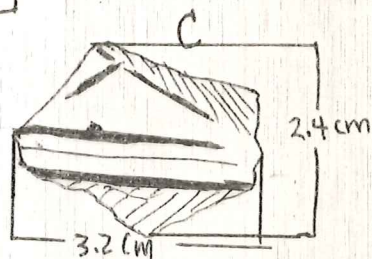

Munsell 2.5YR 6/6 light red
Thickness 0.6 cm

3 pieces of various design. Fragments
are probably red figure body sherds.

TEXAS

Date: 11 June 1981

No. PE-81-265P

Object: Gray Ware Bowl (3 feet on Flat Base) Material: Pottery

Square: J-1 Ramp
Seat: 3 feet on
Olive Ground to the
Level: Gray Sand.

Photograph:

Drawing:

Dimensions: L., H., max. preserved. W., Th. of body: 0.4 cm.

Technique: Diameter of base 7.7 cm. (7.6 cm.)

Condition: Fragmentary, slightly encrusted - Fair

Description: (from PE-81-269P)

This portion of a flat-bottomed, 3-footed bowl comprises 4 sherds.

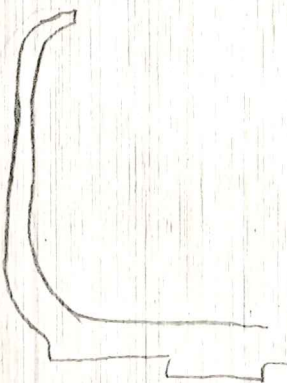

drawing not to scale.

TEXAS

Date: 11 June 1981

No. PE-81-266P

Object: Moulded Gray ware bowl - Rim + Body

Material: Pottery

Square: J1 - 1 Ramp
Sect. B Yellow/olive
Level: Brown to Dk. Gray

Photograph:

Drawing:

Dimensions: L.,

H., 6.5cm.

W.,

Th., of body: 0.4cm.
of rim: 0.2cm.

Technique:

(max. p. preserved)

Condition:

Fragmentary,
Fair - slip well worn on exterior + encrusted

Description: (from PE-81-267PH)

This portion of a moulded gray ware bowl comprises 5 fragments.

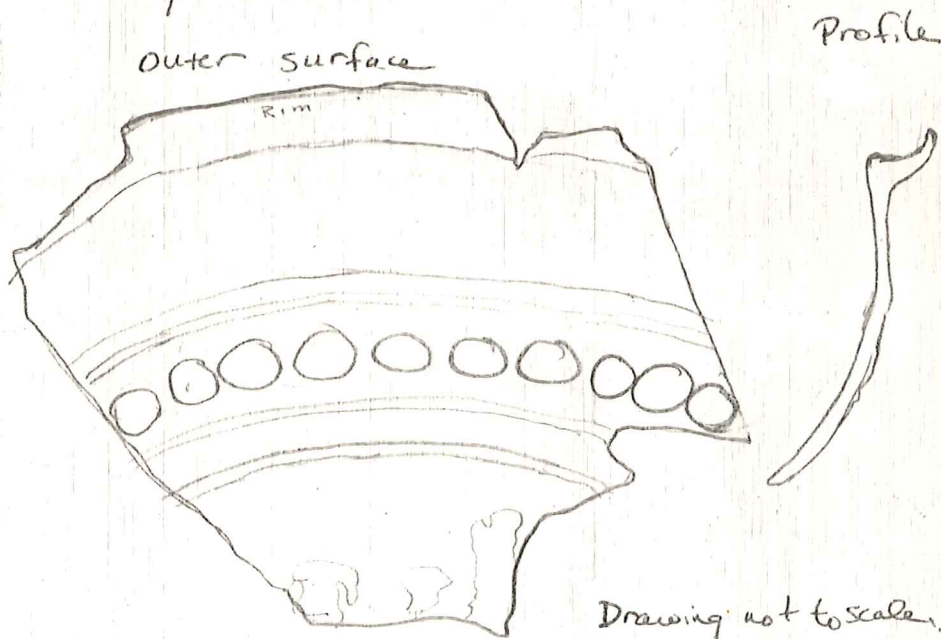

Slips very dark gray + well preserved on interior, and well worn on outside.

TEXAS

Date: 11 June 1981

No. PZ-81-268P

Object: Gray Ware Bowl

Material: Pottery

Square: J-1 Ramo
sect. B S. End Yellow
O.ve. Brown to dk. Gray

Photograph:

Level:

Drawing:

Dimensions: L.,

H., 8.3cm.

W.,

Th., of rim 0.4cm.

Technique: Dian. 18cm.

Condition: Fragmentary, Fair - encrusted, scratched, worn.

Description: (from PZ-81-267PL)

Profile

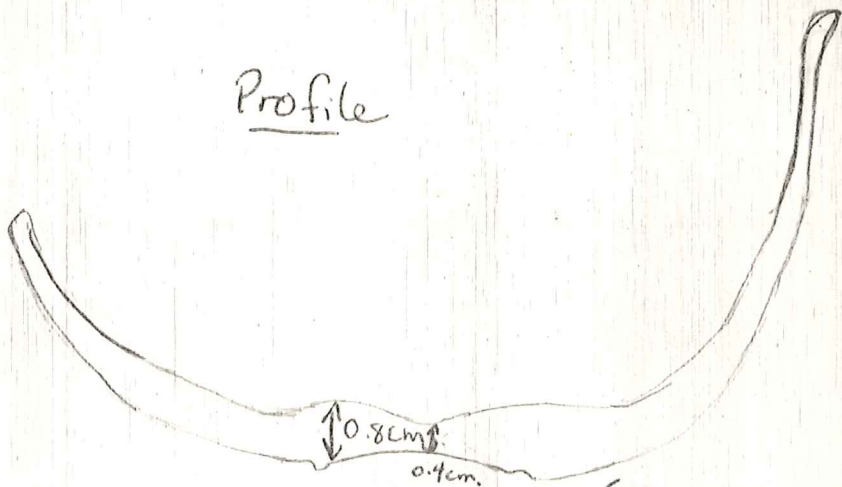

Base is flat, with (Drawing not to scale) groove separating it from rest of vessel

Exterior: slip completely worn off over most of the middle section of the bowl. There are about 4 incised lines, or perhaps 5 around the top edge near the rim. The incised lines form a band 1.2cm. wide.

Interior slip is uneven, but in better presentation than on outside.

TEXAS

Date: 11 June 1981

No. PZ-81-270B

Object: Bone

Material: Bone

Square: PZ-81

Photograph:

J 1 - 1 Ramp Sec. B

Level: Yellow-olive g. - dark grey sand

Drawing:

Dimensions: L.,

H.,

W.,

Th.,

Technique:

Condition:

Description:

Cervus elaphus - Left radius - proximal frag.

TEXAS

Date: 11-VI-81

No. PZ-81-272B

Object: Dog jaw

Material: Bone

Square: J-1 Ramp
Sec B N end of ramp
As h dog to Lt. Gray
Level:

Photograph:

Drawing:

Dimensions: L.,

H.,

W.,

Th.,

Technique:

Condition:

Description:

TEXAS

Date: 11 June 1981

No. PE-81-276P

Object: Rim + Part of Body of Gray Ware Plate Material: Pottery

Square: F 1-1 Sect B
Ramp S. End
Yellow to Dk. Gr
Level: Br.

Photograph:

Drawing:

Dimensions: L.,

H., ^{max. preserved}
5.3 cm.

W.,

Th. of rim 0.4 cm.
of body 0.6 cm.

Technique: max. Preserved diameter - at bottom 6.2 cm.

Condition: Good - slightly incrustated + scratched. Slip well preserved

Description: (from PE-81-273P)

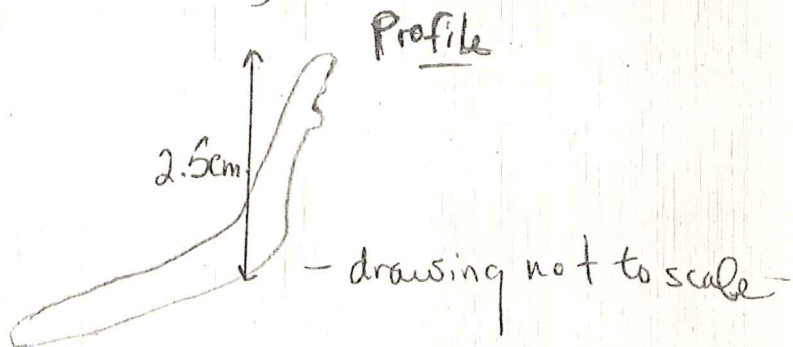

Slip is even on interior and unevenly dripped on exterior. There is a ridge or flange 0.7 cm. below the rim on the outside, and a much lower ridge 0.4 cm. below the rim - between the rim + the larger ridge.

TEXAS

Date: 11 June 1981

No. PE-81-277P

Object: Gray Ware neck, Rim + Strainer

Material: Pottery

Square: J¹-1 Sect. B
Ramp S. End

Photograph:

Level: Yellow to Dk. Gray Brown

Drawing:

Dimensions: L.,

H., max. preserved W.,
6.4cm.

Th., of rim: 0.4cm.

Technique: Diameter of rim = 5.6 Inner Diam. of rim, 4.0cm.

of body: 0.4cm.

Condition: Fragment in fair state of preservation

Description: (from PE-81-273P)

Frag. is encrusted slightly all over. 4 large strainer holes. There is a low raised band running around the base of the neck. Slip is very evenly applied to exterior, & dripped through strainer holes on interior.

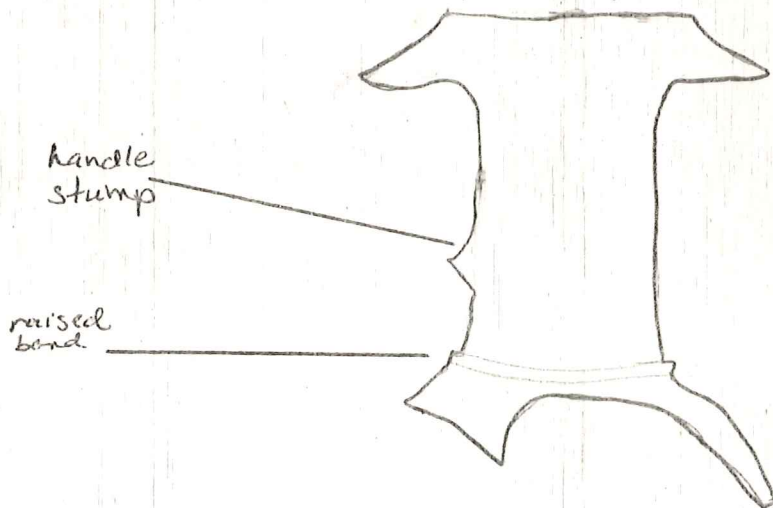

drawing not to scale.

Inner edge of lip is raised straight up 0.2cm. From there the rim slopes gradually out to the edge, and is 0.9cm. wide

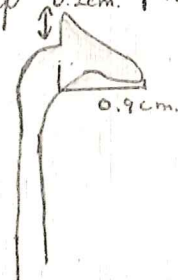

TEXAS

Date: 2 June 1981

No. PZ-81-278P

Object: Frag. Gray Ware Plate

Material: Ceramic

Square: West of US
French, J¹-1, Center
Batt. 12, yellow to

Photograph:

Level: gray soil

Drawing:

Dimensions: L.,

H., 6.5 cm

W.,

Th.,

Technique:

rim to base

Maximum diameter 13.0 cm
(base to rim edge)

Condition: Somewhat encrusted, fragmentary

Description: from PZ-81-46PL.

Fragmentary gray ware plate w/ wide slightly offset rim, the edge of which is not preserved. The interior of the vessel slopes gently upward from the base to the edge of the rim (inner edge) which rises vertically. The top portion of the rim lies at approximately a 90° angle from the vertical inner edge. The expanse of the rim is 2.5 cm at the greatest point. Because of the fragmentary nature of the edge of the rim it is difficult to determine the exact nature of the rim, if there was any, on the exterior of the vessel. The vessel slopes gradually upward from the round foot to the edge. There is a small dip, (1.5 cm) just below the outer edge of the vessel. Approximately 1/4 of the foot is preserved. The foot is round and ~0.7 cm in height. The glaze on the interior is black (center) tending to grayish black. The large portion of the rim is black & dark gray. The latter appears to have been black at one time. The exterior is black around the top and streaked black and gray below. Some of the glaze appears to have flaked off. The bottom portion of the bowl is gray w/ black glazed dribbled. The foot is gray w/ some traces of black glaze remaining. The clay is fine w/ a few inclusions. Compact

TEXAS

Date: 11 June 1981

No. PZ-81-280P

Object: 3 frags. moulded grayware ^{bowl} Material: Pottery

Square: J-1 Sect. B
Ramp N. End

Photograph:

Level: Ash & Ceramic Deposit Drawing:

Dimensions: L.,

H., 8.9cm.

W.,

Th., at base 0.6cm.

Technique: Diam. of base: 5.4cm. ext. diam at rim: 13.6cm. at rim 0.4cm.

Condition: Poor - very heavily encrusted, very little slip preserved

Description:

(from PZ-81-298PL)

One badly frag does not join. The other 2 form the complete profile. There is one satyr's head foot preserved, above which is a moulded leaf pattern. The moulded leaf pattern goes about half way up the bowl where there are circles of clay (moulded also) alternating with the leaf tips going around the bowl. Above this is a band with tiny circles in the middle. Next, a triple leaf pattern in a wide band encircles the vessel. This wide band is separated from the undecorated band above it by another narrow moulded band with no tiny circles in it. Above the plain band is the rim which flares out sharply and then up, forming an interior edge, much like rims made to receive lids. The interior was glazed at least as far down from the rim as the bottom of the plain band on the exterior.

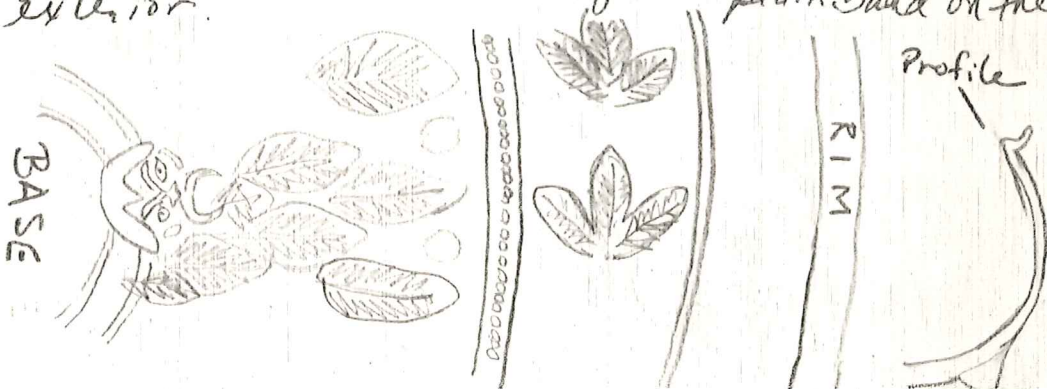

TEXAS

Date: 11 June 1981

No. PE-81-281P

Object: Kim, handle + body of ^{glazed semi-fine} thin ware Material: Pottery

Square: J-1 Bath. 18C

Photograph:

Dk. Gray Brown

Level: to Virgin

Drawing:

Dimensions: L.,

H.,

W.,

Th. of rim: 0.4 cm.

of body 0.3 cm.

of handle 0.6 cm.

Technique:

Fragmentary - comprising 3 sherds.

Condition:

Poor - paint almost all worn off, many scratches.

Description: (from PE-81-262 PL)

Munsell: Fabric - 7.5YR 7/4 (pink)
Glaze 5YR 7/8 (yellowish red)

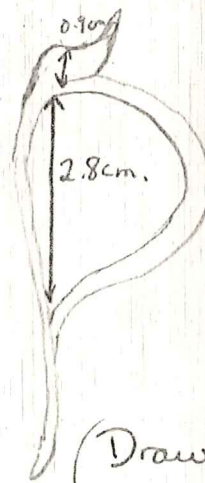

(Drawing not to scale)

TEXAS

Date: 19, June 1981 No. PZ-81-2825

Object: Column Capital Frag. Material: ^{calceolita} di Gravene

Square: N-W trench Photograph:

Cleaning level:

Level: Drawing:

Dimensions: L., H., W., Th.,

Technique:

Condition: Pitted + worn, fragmentary

Description:

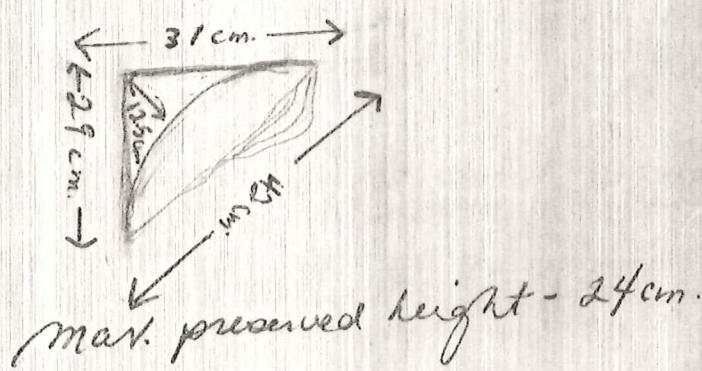

Drawn by architects 1981 called "Column Capital"

TEXAS

Date: 19 June 1981

No. PE - 81 - 283T-A

Object: Moulded Architectural Fragment

Material: Terra cotta

Square: Tile kiln from cleaning & restoration

Photograph:

Level:

Drawing:

Dimensions: L.,

H.,

W.,

Th.,

Technique:

Condition: Fair - heavily encrusted; paint is worn.

Description: Two moulded terracotta architectural fragments.

A) Munsell: - on back of fragment there are many shades - most predominant are: 2.5YR 6/8 (light red), 7.5YR 6/4 (light brown), 7.5YR 7/4 (pink).

Fragment has 2 finished edges and the corner where those edges meet preserved.

Spiral design is 1.5 cm. wide at beginning, on outside of spiral, and 0.3 cm. wide at most narrow point on inside.

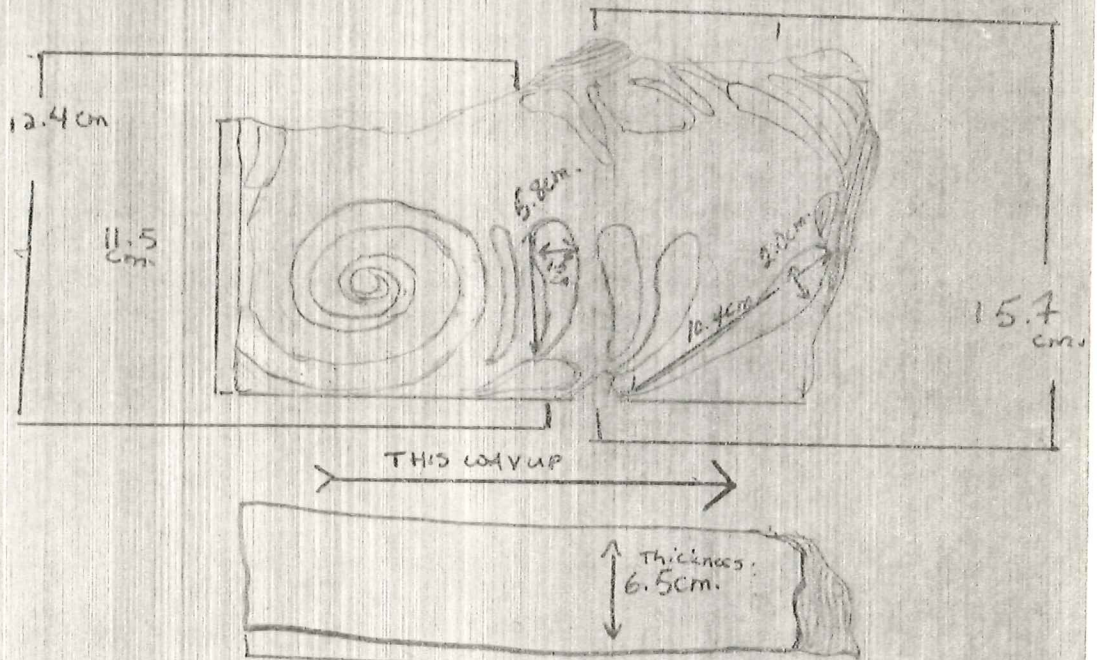

TEXAS

Date: 19 June 1981

No. PE-81-2837-B

Object: Moulded Architectural Fragment - ^{Cyrene} Material: Terra cotta

Square: Tile Kiln
- from cleaning
Level: restoration

Photograph:

Drawing:

Dimensions: L., H., W., Th.

Technique:

Condition: Fair - heavily encrusted, paint is worn.

Description: 5YR 8/1 (white) on worked edge.
B: Munsell: 10YR 8/4 (very pale brown) on chipped parts
10YR 7/8 (very pale brown) next to spirals.
• There are traces of black paint on both spirals.

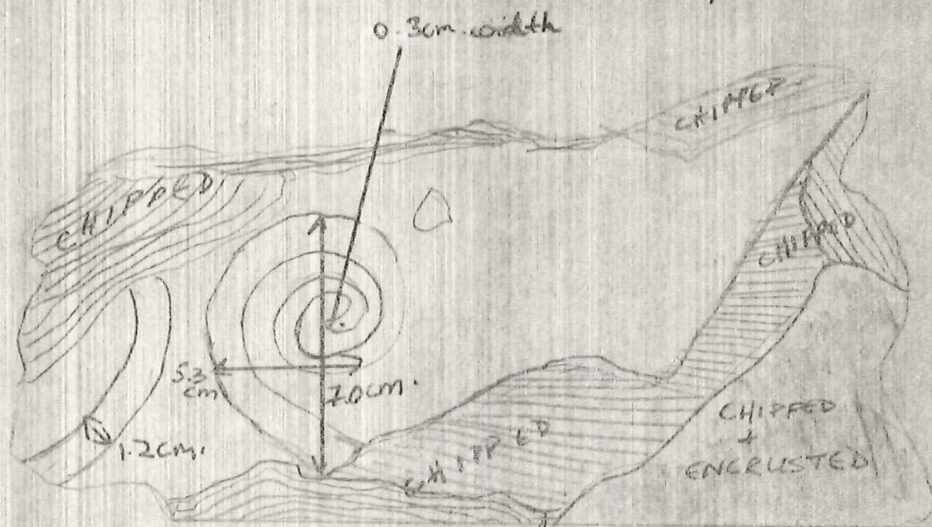

top is not a finished edge

flat, finished bottom

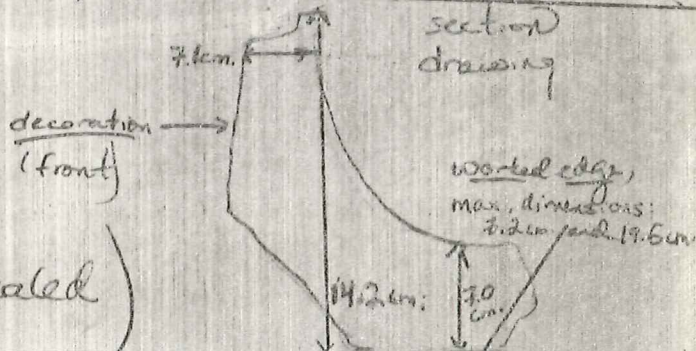

Note: These 2 fragments were found in the top of the wall of the kiln. They were part of the kiln structure.

TEXAS

Date:

11 June 1981

No.

PZ-81-

2848

Object:

Bones

Material:

Bone

Square: J'-1 Batt. 13B.

Photograph:

C. side Dk. Brown /

Lt. Gray

Drawing:

Level:

Dimensions: L.,

H.,

W.,

Th.,

Technique:

Condition:

Description:

TEXAS

Date: 12 June 1981

No. PE-81-285B

Object: Bone

Material: Bone

Square: J¹-1 Bot. 148
Dk. gray w. Sides

Photograph:

Level:

Drawing:

Dimensions: L.,

H.,

W.,

Th.,

Technique:

Condition:

Description:

TEXAS

Date: 15 June 1981

No. PE 81-286B

Object: BONES

Material: Bone

Square: J-1 Bat. 16D
w. Ceramic

Photograph:

Level: Deposit -

Drawing:

Dimensions: L.,

H.,

W.,

Th.,

Technique:

Condition:

Description:

TEXAS

Date: 11 June 1981 No. PZ - 81 287B

Object: Bones Material: Bone

Square: J-1 Batt. 180 Photograph:

Ok. Gray-Brown

Level: to Virgin Drawing:

Dimensions: L., H., W., Th.,

Technique:

Condition:

Description:

TEXAS

Date: 11 June 1981

No. PZ-81 - 288P

Object: Gray ware Fragment ? Lid or Base? Material: Pottery

Square: J-1 Sect B
Ramp S. end

Photograph:

Level: Yellow to Dk. Gr. Br.

Drawing:

Dimensions: L., H., max. preserved W., inner to outer Th., of rim. 0.4
Technique: 3.2cm. edge of rim: 1.1cm.

Condition: Fragment in Fair state of preservation

Description: (from PZ-81 - 273 Ph)

Encrusted on inside and out. Most of slip is worn away.

incised bands

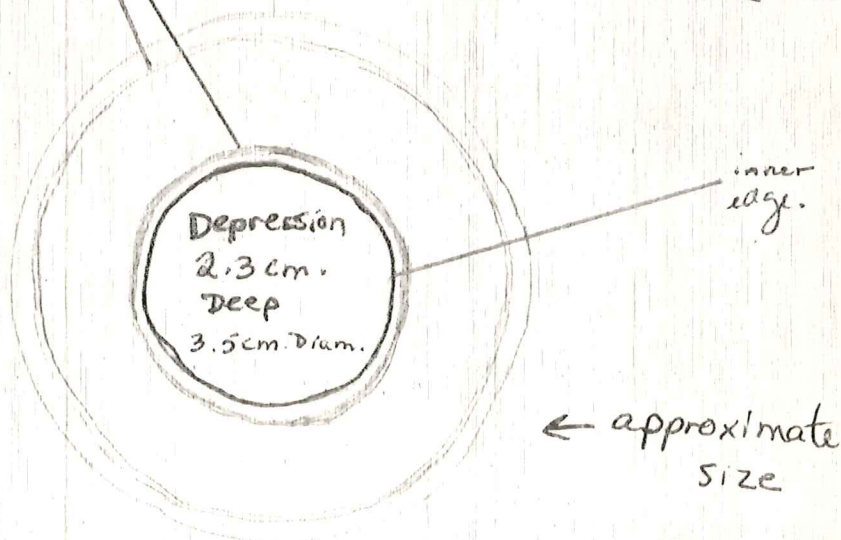
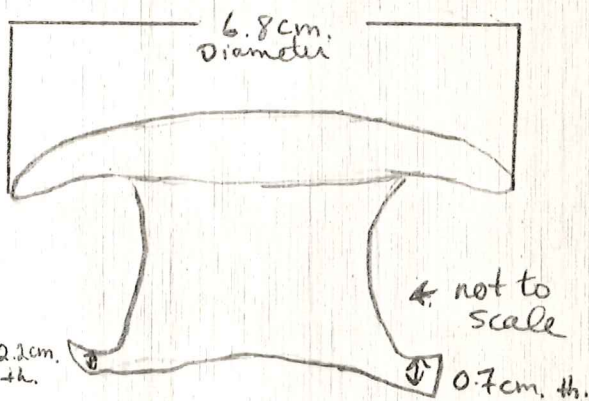

Top View

The depression gets narrower towards the bottom.

TEXAS

Date: 11 June 1981

No. PE-80-288P (cont'd)

Object: Gray Ware Fragment

{lid or base?}

Material: Pottery

Square: J-1 Sect. B

Photograph:

Rango S. End

Level: Yellow to Dk. Gr. Br.

Drawing:

Dimensions: L.,

H.,

W.,

Th.,

Technique:

Condition: Fragment

Description:

Refer to PE-80-270P for a Gray Ware
Strainer with similar proportions and shape.
Could this be an improperly made strainer
without strainer holes?

TEXAS

Date: 11-VI-81

No. PZ-81-289 B

Object: Bone

Material: Bone

Square: J-1 Sec. B lamp
S. end yellow to DK
sr Brown
Level:

Photograph:

Drawing:

Dimensions: L.,

H.,

W.,

Th.,

Technique:

Condition:

Description:

TEXAS

Date: 11 June 1981

No. PZ-81-291P

Object: Gray Ware Bowl

Material: Pottery

Square: J-1 Sect. B
Ramp S. and Yellow
to Dark Gray Brown
Level:

Photograph:

Drawing:

Dimensions: L.,

H., 7.6cm.

W.,

Th., of rim: 0.35cm
of body: 0.5cm.

Technique: Diam. of base: 3.7cm. Diam. of H. 8cm.

Condition: Fair - Slip worn near rim on exterior; Fragmentary.

Description: (from PZ-81-290 PL)

This portion of a deep grayware bowl comprises one large fragment - base and body - and 3 rim fragments. The base is a round one, formed by an incised, deep band, which separates the base from the body of the bowl. There are 2 incised lines forming a wider band around the mouth of the bowl.

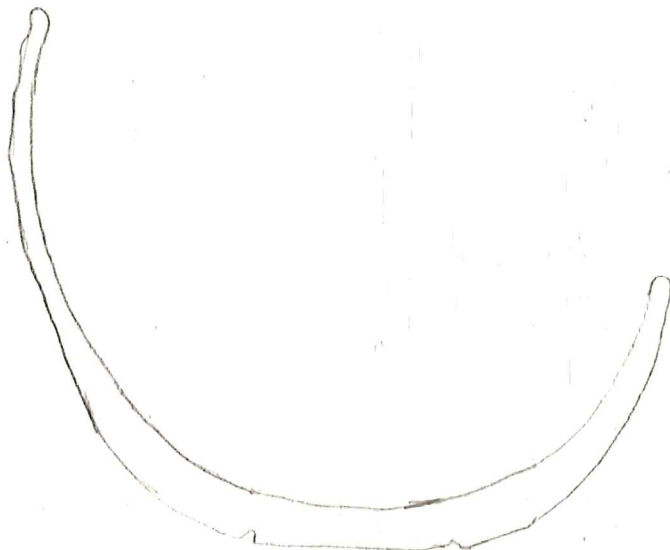

TEXAS

Date: 11 June 1981

No. PZ-81-292P

Object: Complete Profile, plus 2 rim sherds
Orange glazed Bowl

Material: Pottery

Square: J-1 Sect. B
Ramp S. and
Yellow to Dk.
Level: Gray Brown

Photograph:

Drawing:

Dimensions: L.,

H., 6.1 cm.

W.,

Th., near base

Technique:

Diam. 12.9 cm.

Diam. of base 4.9 cm.

0.7 cm.

Condition:

Fragmentary.

Th. at rim 0.3 cm.

Poor - most of slip is gone; slight encrustation all over.

Description:

(from PZ-81-290PL)

Complete profile and 2 rim sherds which do not join. Slip originally covered entire vessel, is preserved in only a few spots.

Munsell: 5YR 8/4 (pink) slip: 2.5YR 5/8 (red).
Fabric is powdery semi-fine dull ware. There is no decoration other than the slip.

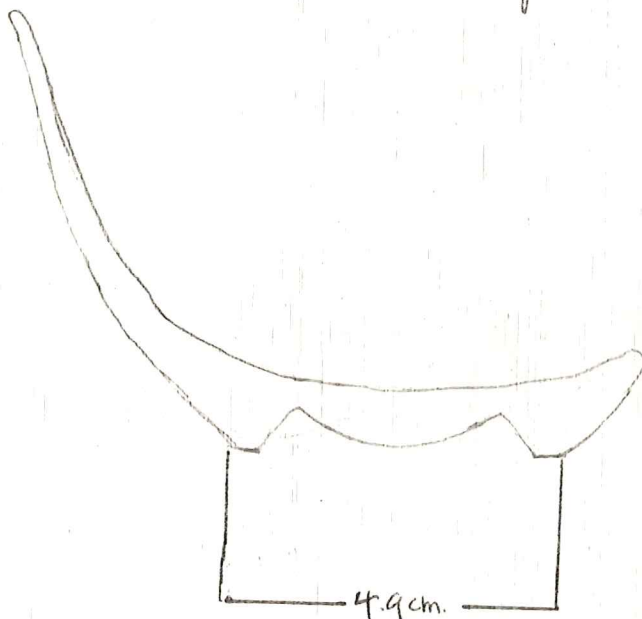

TEXAS

Date: 11-VI-81

No. PZ-81-293 B

Object: Bone

Material: Bone

Square: J¹-1 Section B
Ramp S. end yellow
to DK gray Brown
Level:

Photograph:

Drawing:

Dimensions: L.,

H.,

W.,

Th.,

Technique:

Condition:

Description:

TEXAS

Date: 11-VI-81

No. PZ-81-295M

Object: Slag

Material: Slag

Square: New Ramp
sect B J-1
yellow to brown

Photograph:

Level:

Drawing:

Dimensions: L.,

H.,

W.,

Th.,

Technique:

Condition:

Description:

14 chunks of slag

TEXAS

Date: 11-VI-81

No. PZ-81-296B

Object: BONE

Material: BONE

Square: New Ramp
Sec. B J'-1
Level: yellow to brown

Photograph:

Drawing:

Dimensions: L.,

H.,

W.,

Th.,

Technique:

Condition:

Description:

TEXAS

Date: 11 June 1981

No. PE-81-297P

Object: Rim Section of Glazed Fine Ware Bowl Material: Pottery

Square: J-1 Sect. B
Range M. End Ceramic
Level: Deposit.

Photograph:

Drawing:

Dimensions: L.,

H. (max. preserved) W.,

Th., of rim 0.3cm.

Technique:

5.2cm.

of body 0.4cm.

Condition: Fair. - Orange slip nearly gone. Fragmentary - 8 sherds

Description: (from) PE-81- (P) Chipped in several places

Exterior Decoration - 2 incised lines near rim - not carefully done. Upper part of bowl is orange glazed, below this the bowl is gray, with some orange discoloration in it in spots.

Munsell - fabric above gray: 5YR 7/6 (Reddish Yellow)
orange glaze: 10R 5/8 (Red).

Core of the vessel fabric is gray: Munsell: 2.5Y 4/6 (gray)

Interior - there is one lump of clay on the upper wall that was never smoothed out by the potter. The glaze is orange and gray blotchy on the interior.

Fabric is powdery semifine.

This bowl was a deep one. Estimated Diameter at mouth - 13cm.

TEXAS

Date: 11 June 1981

No. PZ-81-29TT

Object: Pyramidal Loom Wt.

Material: Terracotta

Square: J1-1 Sect. B

Photograph:

N. end Ramp

Level: Ash Ceramic Dept Drawing:

Dimensions: L.,

H., 6.4 cm.

W.,

Th., at top:

Technique:

Condition: Good - scratched + encrusted.

Description: (from PZ-81-298 PL)

Munsell: 5YR 7/6 Reddish Yellow

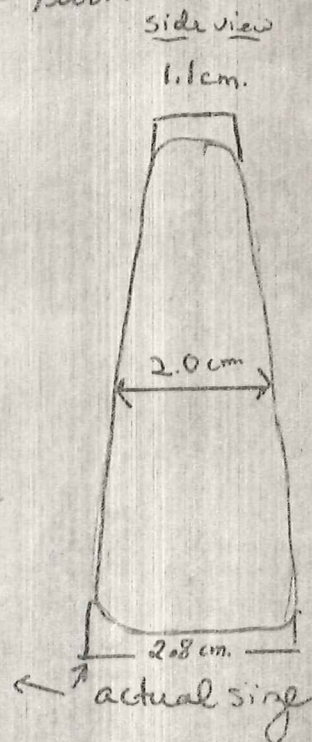
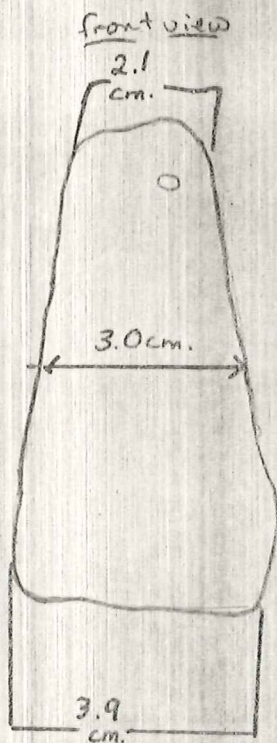

TEXAS

Date: 11-VI-81

No. PZ-81-300 P A, B

Object: two stamped ^{approximate} handles

Material: Pottery

Square: J1-1 Section B
N. end Ramp-Ash +
ceramic deposit
Level:

Photograph:

Drawing:

Dimensions: L.,

H.,

W.,

Th.,

Technique:

Condition: good but fragmentary

Description: From PZ-81-298 PL
2 stamped handles - Handles read
DAMOKRATHS -

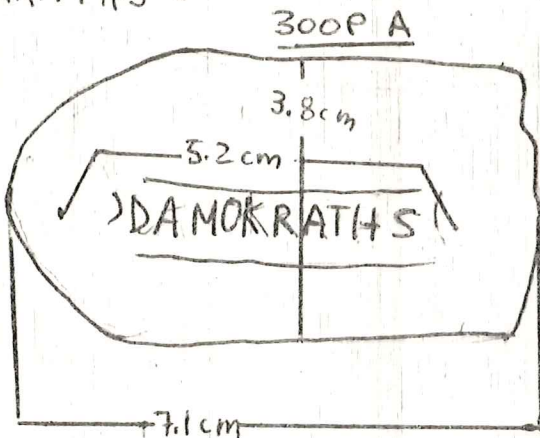

approx. thickness
2.4 cm

Munsell 5YR
7/4 pink

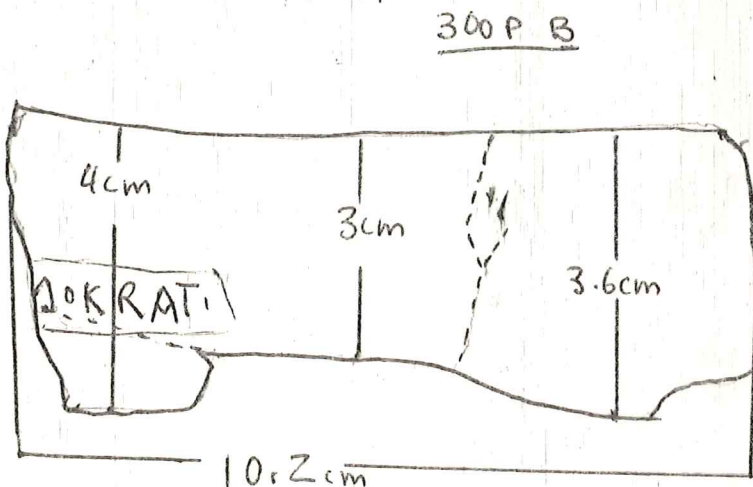

2.4 cm
approx. thickness

Munsell 5YR
7/6 reddish
yellow

TEXAS

Date: 11 June 1981 No. PE-81-301B

Object: BOXES Material: BONE

Square: J-1 Sect. B Photograph:

Ramp N. End
Level: Ceramic Deposit Drawing:

Dimensions: L., H., W., Th.,

Technique:

Condition:

Description: (from PE-81-298 PL)

TEXAS

Date: 11 June 1981

No. PZ-81-302P

Object: Large Coarse Ware Amphora

Material: Pottery

Square: J-1 Ramp
Sect. B N. End

Photograph:

Level: DE Gray/Brown

Drawing:

Dimensions: L.,

H.,

W.,

Th.,

Technique:

Condition:

Fragmentary - Fair to Poor

Description:

(from PZ-81-271 PL)

These are shreds making up this portion of a large coarse ware amphora from PZ-81-267 PL, and PZ-81-269 PL.

TEXAS

Date: 11 June 1981

No. PE-81-303B

Object: Boxes

Material: Boxes

Square: J-1 Sect. 3
Ramp N. End

Photograph:

Level: Ceramic Deposit

Drawing:

Dimensions: L.,

H.,

W.,

Th.,

Technique:

Condition:

Description:

(from PE-81-298 PL)

TEXAS

Date: 11 June 1981

No. PE-81-304P

Object: Large Coarseware Amphora <sup>NECK, RIM,
HANDLE +
SOME BODY</sup> Material: Pottery

Square: Ramp Sect. B
N. End Ash Deposit
Dark Gray Brown
Level: Light Gray 1-2

Photograph:

Drawing:

Dimensions: L., H., W., Th.,

Technique:

Condition: Fragmentary - Poor Composes 40 Shards

Description: 1 from PE-81-267 PL

There are shards in and/or with this amphora from
PE-81-253 PL (1 shard), PE-81-269 PL (5 shards),
PE-81-255 PL (1 shard), PE-81-271 PL (4 shards),
PE-81-274 PL (4 shards), PE-81-275 PL (1 shard),
PE-81-290 PL (3 shards), PE-81-298 PL (7 shards)

Neck + Rim section - only part of one handle preserved.
max. preserved height: 18.0cm. Interior diam. of lip: 14.9cm.
(Munsell: 10R 6/4 (pale red).) exterior diam. of lip: 15.7cm.
Thickness of neck: 0.9cm.
Thickness of handle:
2.5cm.
Width of handle at top
4.6cm.

TEXAS

Date: 11 June 1981

No. PZ-81-305P

Object: Misfired Amphora

Material: Pottery

Square: J'-1 Sect. B
N. end Ramp
Ash + Ceramic Deposit

Photograph:

Level:

Drawing:

Dimensions: L.,

H.,

W.,

Th. at rim:

0.6cm.

Technique:

Condition: In Fragments - Poor - NO Handles or handle stamps.

Description:

(from PZ-81-298 Pt)
PZ-81-275 Pt, PZ-81-269 Pt major

This vessel comprises many fragments. There are 3[^] (there are 4 sherds comprising a small rim section too) portions which do not join, and 18 sherds or

small joined groups of sherds which do not join either. The base section: 6 sherds - Body section: 11 sherds Neck + Shoulder Sect - 14 sherds. It is badly misfired and is black and red - varying shades over the surfaces of the vessel. The bottom

of the base has a large part of an air bubble missing - the remaining part is flaky and thin (0.7cm).

The interior and exterior of the vessel are mainly black. The core of it is red.

Munsell: exterior { 5YR 7/6 (pink)
5YR 5/1 (gray)
5YR 7/3 (pink)

core - 2.5YR 5/6 (red).

interior - 5YR 4/1 (dark gray)
5YR 7/6 (reddish)

Profiles of 3 major sections

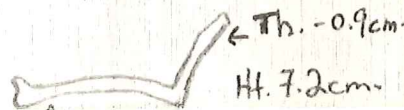
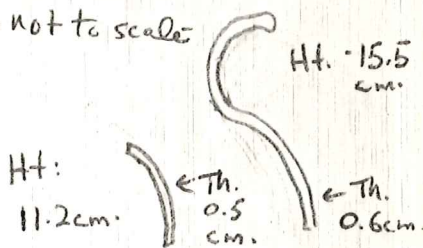

TEXAS

Date: 11-VI-81

No. PZ-81-306P

Object: large amphora neck

Material: Pottery

Square: J-1 section B
N. end Ramp
Ash and ceramic
Level: deposit

Photograph:

Drawing:

Dimensions: L.,

H.,

W.,

Th.,

Technique:

Condition: good but fragmentary

Description: From PZ-81-298 PL

One fairly large amphora neck and two handles.

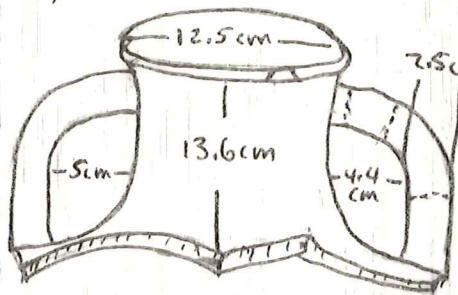

Munsell 5YR
7.8 reddish yellow

approx thickness, 9 cm

right handle of amphora is broken in 3 places ^{lip of} neck
is slightly chipped. Handles are decorated with
two incised lines - Material of vessel is porous,
coarse, sandy fabric

TEXAS

Date: 11-VI-81

No. PZ-81-307 P

Object: profile of semi-fine vessel

Material: Pottery

Square: J-1 Section B
Mend Ramp - Ash
and ceramic deposit
Level:

Photograph:

Drawing:

Dimensions: L.,

H.,

W.,

Th.,

Technique:

Condition: encrusted and fragmentary

Description: From PZ-81-298 PL

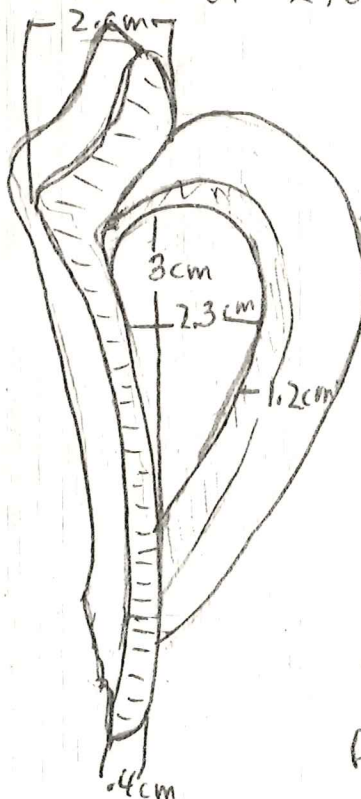

1 profile of semi-fine vessel.

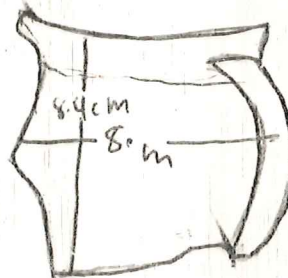

munsell. 10R 6/4 pale pink.
approx thickness .4 cm.

fabric of vessel is hard.
vessel was well crafted.

TEXAS

Date: 11-VI-81

No. PZ-81-308P

Object: large Amphora handle and part of rim Material: Pottery

Square: S-1 Section B
N. end Ramp
Ash + Ceramic deposit
Level:

Photograph:

Drawing:

Dimensions: L.,

H. (max. preserved) W.,

Th. of rim: 2.9cm.
(at widest part)
if neck: 0.9cm.
if handle: 2.1cm.
of body: 0.8cm.

Technique:

24.2cm.

Condition: Encrusted, comprises 7 sherds

Description: (From PZ-81-298 PL)

Munsell: 5YR 7/6 (reddish yellow).

Fabric is coarse with small inclusions.

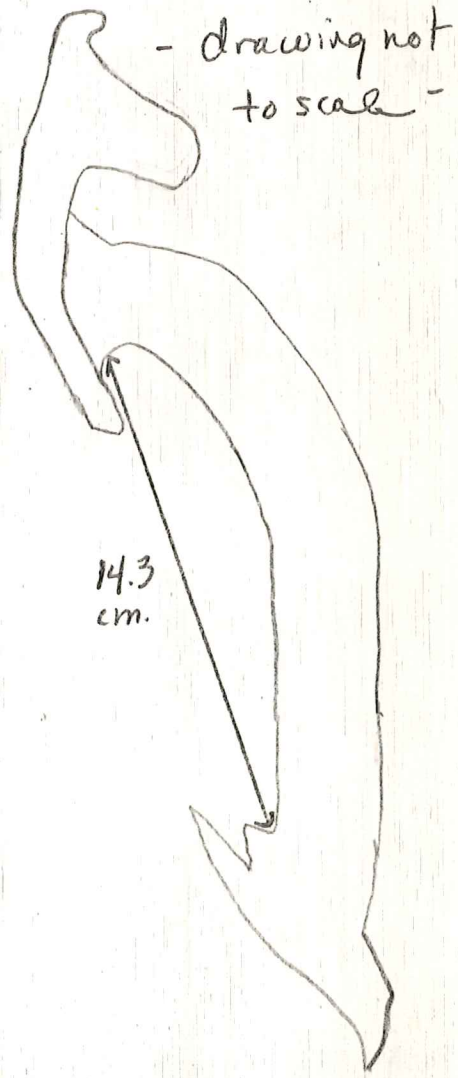

TEXAS

Date: 11-VI-81

No. PZ-81-309 P

Object: cook ware dish

Material: Pottery

Square: J'-1 Section B
N. end Ramp. Ash
and ceramic deposit
Level:

Photograph:

Drawing:

Dimensions: L.,

H.,

W.,

Th.,

Technique:

Condition:

Description: From PZ-81-298 PL

Fragmented base of cookware flat dish in
6 piece. Unfortunately there is not a complete
profile. Munsell 5YR 7/8 to 6/8 reddish yellow

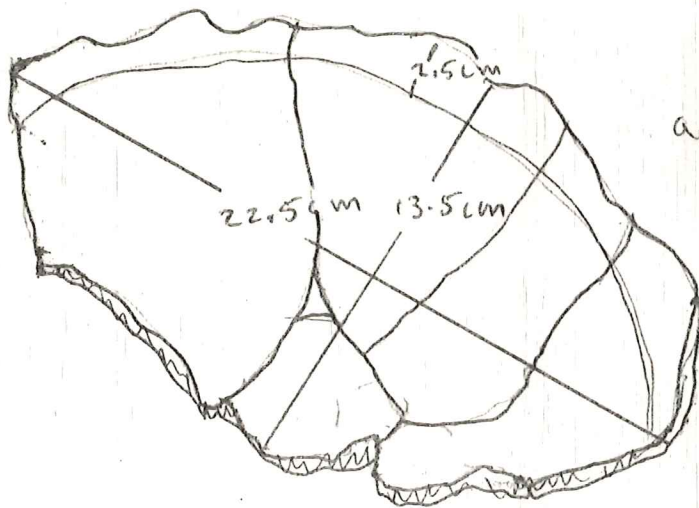

approx thickness
0.5 cm

TEXAS

Date: 11-VI-81

No. PZ-81-310 P

Object: Red fig. pottery fragment

Material: Pottery

Square: Ramp Section B
J1-1 southend in
yellow olive brown
Level:

Photograph:

Drawing:

Dimensions: L.,

H.,

W.,

Th.,

Technique:

Condition: clear but fragmentary

Description:

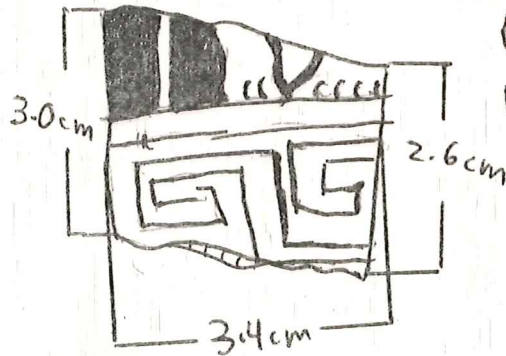

1 red figure pottery
fragment.

Munsell 5YR 7/4 pink

approx thickness 0.5 cm

TEXAS

Date: 11-VI-81

No. PZ-81-311 P

Object: light fabric Pottery fragment

Material: Pottery

Square: J¹-1/K¹-1
But 18C DK Gray
to Virgin
Level:

Photograph:

Drawing:

Dimensions: L.,

H.,

W.,

Th.,

Technique:

Condition:

Description:

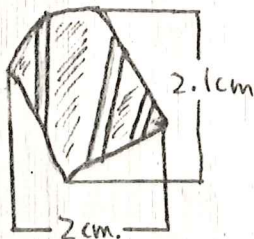

One pottery sherd with
traces of colored slip.
approx. thickness 0.3cm
back of sherd munsell
10YR 8/4 very pale brown

sherd is decorated with 3 incised
lines.

TEXAS

Date: 11-VI-81

No. PZ-81-312P

Object: grayware lamp

Material: pottery

Square: J-1 Sect. B
Ramp N. end above
ash deposit.

Photograph:

Level:

Drawing:

Dimensions: L.,

H.,

W.,

Th.,

Technique:

Condition: good

Description:

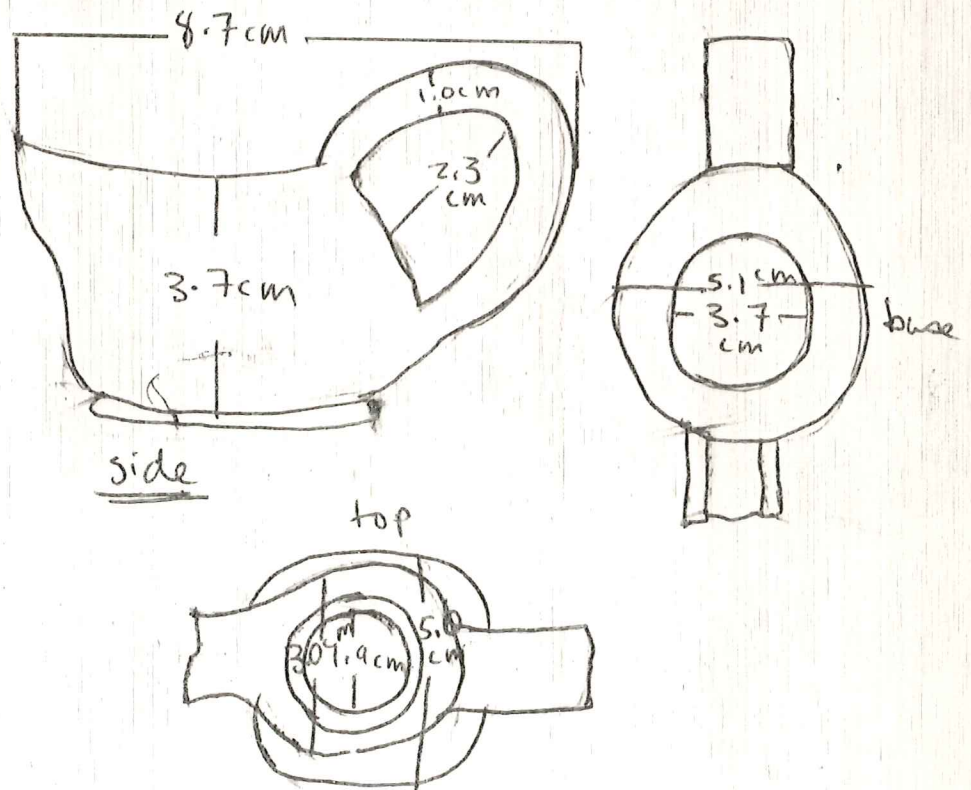

1 gray ware lamp with chipped spot -
slip is slightly irregular

TEXAS

Date: 11-VI-81

No. PZ-81-313P

Object: Red fig. pottery fragment - Rim Material: Pottery

Square: New Ramp
J-1 yellow/olive
brown

Photograph:

Level:

Drawing:

Dimensions: L.,

H.,

W.,

Th.,

Technique:

Condition: fragmentary and chipped.

Description:

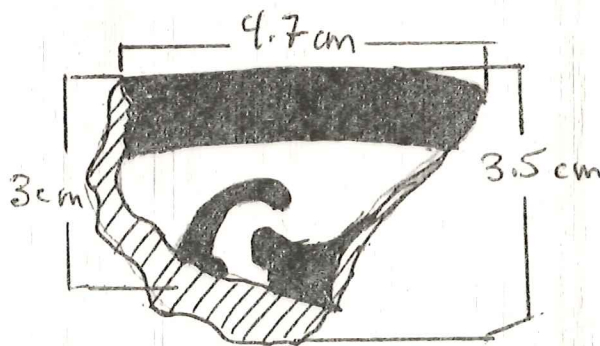

1 red figure pottery
fragment probably
a rim.
design seems to
suggest an ivy
pattern

approx thickness 0.7 cm

munsell 5YR 7/4-7/6 pink to reddish
yellow

TEXAS

Date: 11 June 1981

No. PZ-81 - 314P

Object: Small Coarse Ware ^{part of neck - handle + body} Jero-Anplina - Material: Pottery

Square: J¹-1 Batt. 18C

Photograph:

Dk. Grey Brown
Level: to Virgin

Drawing:

Dimensions: L.,

H., max. preserved
15.7 cm. W.,

Th., 0.6 cm. - body
1.2 cm. handle

Technique:

Condition: Fair - Fragmentary + encrusted - 7 sherds

Description: (from PZ-81 - 262 PK - P4II)

Munsell: 5YR 7/6 (Reddish Yellow) -

2 raised bands form the decoration around the base of the neck.

The handle has 2 raised ridges on the outside. Inside has root marks, or some strange encrustation pattern all over. Some carbonized material remains on the interior of 2 pieces making up this section.

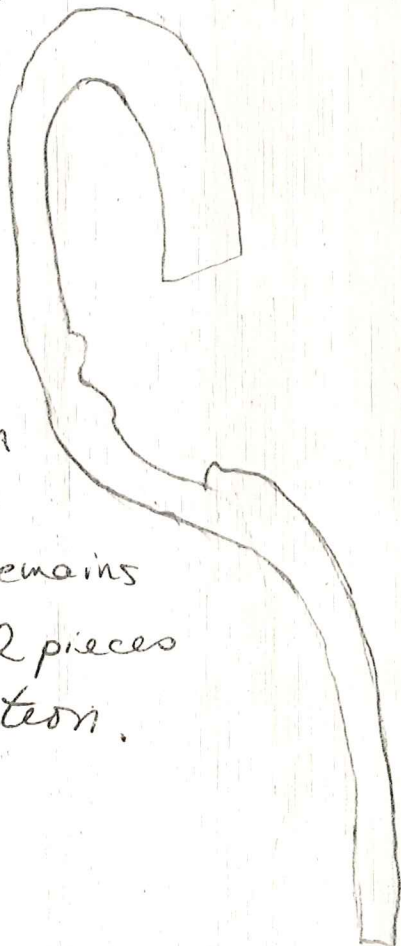

TEXAS

Date: 11 June 1981

No. PZ-81-315P

Object: Rim of Shallow Coarse Ware Dish ^{w/ lead clamps.} Material: Pottery

Square: J-1 N. End
Sect. B. Ramp Ashtr

Photograph:

Level: Ceramic Deposit

Drawing:

Dimensions: L.,

H., max. preserved W.,
5.7 cm.

Th. of rim: 2.9 cm
at max. point.
of body 0.7 cm.

Technique:

Condition: Fair - eroded, slip worn

Description: Munsell: interior - 5YR 6/8 (reddish yellow)
exterior - same as interior
glaze - 2.5YR 5/8 (red)

Glaze remains on outside of rim only. There is a piece of a lead clamp which is not attached to the fragment

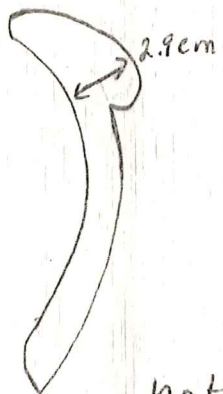

- not to scale -

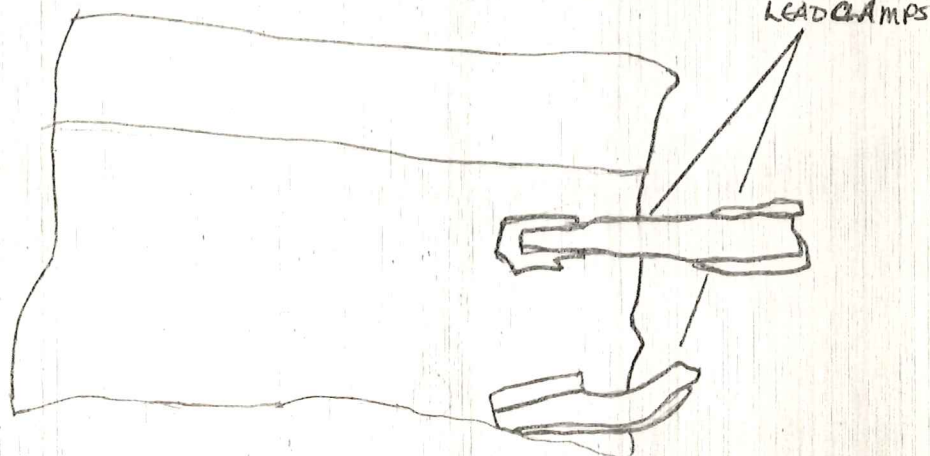

* Does not join with PZ-81-254P

TEXAS

Date: 11-VI-81

No. PZ-81-316T

Object: Terracotta votive fragment

Material: Terracotta

Square: J¹-1 Bath 13 B

Photograph:

E side, gr-brown
lt gray-grayish

Drawing:

Level: mottled

Dimensions: L.,

H.,

W.,

Th.,

Technique:

Condition: weathered - fragmentary

Description:

one weathered terracotta votive fragment
possibly showing satyr's hoof.

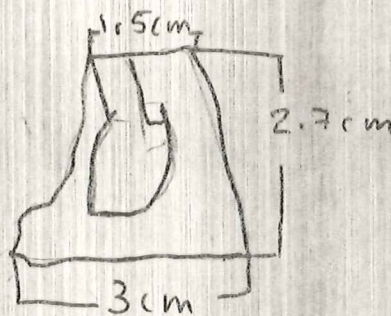

approx thickness
0.6 cm

Munsell
5YR 7/6 reddish
yellow

TEXAS

Date: 11-VI-81

No. PZ-81-317 M

Object: BRONZE coin

Material: BRONZE

Square: New Ramp
J-1 Sect. B just
above ceramic deposit
Level:

Photograph:

Drawing:

Dimensions: L.,

H.,

W.,

Th.,

Technique:

Condition: encrusted.

Description:

Very small piece of bronze, flat on one
side and curved above.

Diameter 1.05 cm

Thickness 0.25 cm

TEXAS

Date: 11-01-81

No. PZ-81-318 SS

Object: Charcoal chunk

Material: Charcoal

Square: J-1 Ramp Sect.

Photograph:

B at Trench. S. end

of ramp yellow to Dkg/b

Drawing:

Dimensions: L.,

H.,

W.,

Th.,

Technique:

Condition:

Description:

1 chunk of charcoal

TEXAS

Date: 12-VI-81

No. PZ-81-319 B

Object: Bones

Material: Bone

Square: J1-1 Bath 16B
w. Ceramic Deposit

Photograph:

Level:

Drawing:

Dimensions: L.,

H.,

W.,

Th.,

Technique:

Condition:

Description:

TEXAS

Date: 12-VI-81

No. PZ-81-320 B

Object: Bones

Material: Bone

Square: J-1 BaH 13B

Photograph:

West 1/2

Level: Gray Brown

Drawing:

Dimensions: L.,

H.,

W.,

Th.,

Technique:

Condition:

Description:

TEXAS

Date: 11-VI-81

No. PZ-81-321 P

Object: large Storage Amphora - fragment of neck and handle
Material: Pottery

Square: J'-1 Section B
N. end Ramp
Ash + Ceramic deposit
Level:

Photograph:

Drawing:

Dimensions: L., H., W., Th.,

Technique:

Condition: very fragmentary and worn

Description: From PZ-81-298 PL

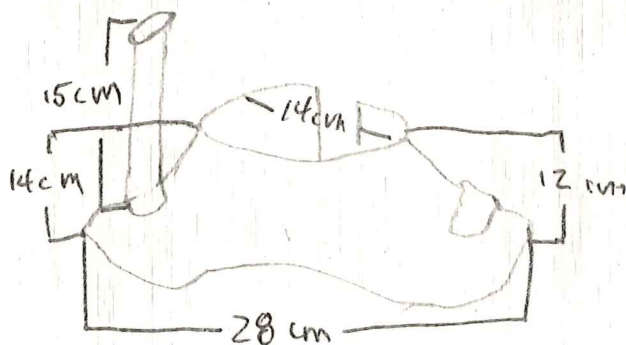

approx thickness
1.5 cm

Munsell
5YR 8/2 pinkish
white

1 fragment from PZ-81-271 PL

2 fragments from PZ-81-290 PL

1 frag. from PZ-81-414 PL

After adding more sherds to neck and below,

max. preserved ht. 27.5 cm.

max. lower dia. is same as above

As yet we have found no rim sherds.

TEXAS

Date: 11-VI-81

No. PZ-81-322 P

Object: Neck of storage amphora

Material: Pottery

Square: K¹-1/J¹-1
Section A Ramp

Photograph:

Level:

Drawing:

Dimensions: L.,

H.,

W.,

Th.,

Technique:

Condition: fragmentary

Description:

from PZ-81-253 PL

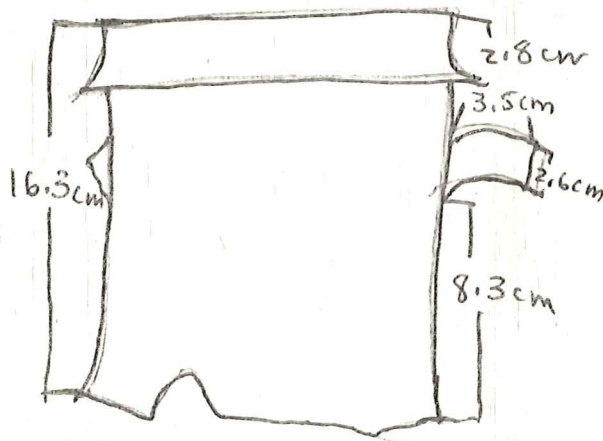

diameter 11.5cm

thickness: 1cm

Munsell

5YR 7/6-7/8

reddish yellow

2 fragments from PZ-81-262 PL

1 fragment from PZ-81-271 PL

1 fragment from PZ-81-298 PL

TEXAS

Date: 12-VI-81

No. PE-81-324B

Object: Boxes

Material: Bones

Square: J¹-1 Bath 14B

Photograph:

Ceramic Deposit

Level:

Drawing:

Dimensions: L.,

H.,

W.,

Th.,

Technique:

Condition:

Description:

TEXAS

Date: 12 June 1981

No. PE-81-325B

Object: Bone

Material: Bone

Square: T-1 Ball
13B West 1/2

Photograph:

Level: Grayish Brown

Drawing:

Dimensions: L.,

H.,

W.,

Th.,

Technique:

Condition:

Description:

TEXAS

Date: 11 June 1981

No. PE - 81 - 226P

Object: Gray Ware Plate - ^{exteri} profile

Material: Pottery

Square: J-1 Sect. B Ramp
S. end Yellow to Dk.
Gray Brown
Level:

Photograph:

Drawing:

Dimensions: L., H., 4.1cm. W., of rim, 3.0cm. Th., of rim, 0.4cm.

Technique: Max Preserved Diam. 10.9cm. (about 1/2)
Est. Diam. of Base 5.9cm. Max. Preserved Diam. of base: 2.9cm. of body: 0.6cm.

Condition: Good - slightly encrusted - Slip is evenly preserved.

Description: Plate diameter is preserved almost to the center point. Base is a ring foot. The rim is raised 0.9cm. from the upper slope of the body. (from PE - 81 - 290 PL)

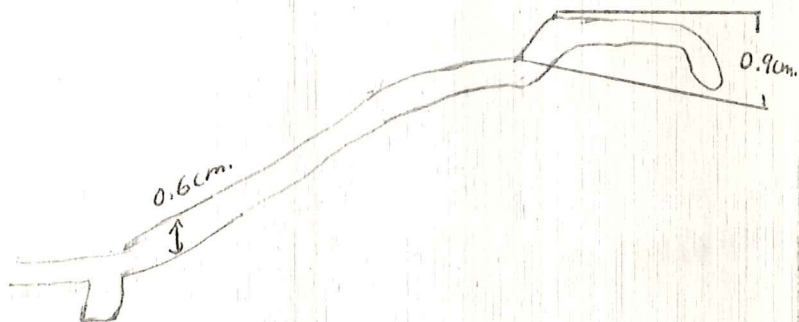

TEXAS

Date: 12 June 1981

No. PE-81-3277

Object: Gray Ware Plate - almost complete

Material: Pottery

Square: J'-1 Batt. 14B
w. Ceramic Deposit

Photograph:

Level:

Drawing:

Dimensions: L.,

H., 6.1cm.

W.,

Th., of rim: 0.4cm.
of body: 0.7cm.

Technique: Diam. of ring foot 7.4cm. Diam. of plate 32.4cm

Condition: - Poor extremely heavily encrusted + worn.

Description:

Comprises 15 sherds. - Fragmentary.

Munsell - core: 5YR 7/4 (pink).

exterior of plate: 10YR 6/3 (pale brown).

Profile

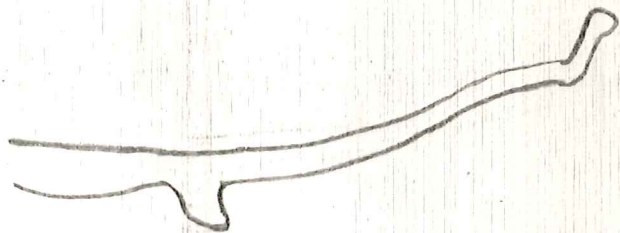

(not to scale)

One sherd from PE-81-

J'-1 Batt. 14B

Ceramic Dep.

12-VI-81

TEXAS

Date: 15 June 1981

No. PZ-81-328B

Object: Bones

Material: Bone

Square: J-1 Batt. 16D
Cerami Deposit

Photograph:

Level:

Drawing:

Dimensions: L.,

H.,

W.,

Th.,

Technique:

Condition:

Description:

TEXAS

Date: 15 June 1981

No. PZ-81-329B

Object: Bore S

Material: Bore

Square: J'-1 Batt. 16D

Photograph:

Ceramic

Level: Deposit

Drawing:

Dimensions: L.,

H.,

W.,

Th.,

Technique:

Condition:

Description:

TEXAS

Date: 11 June 1981

No. PZ-81-330P

Object: ² Parts of Cookware Vessel ^{Rim + Handle} Body Material: Pottery

Square: J'-1 Ramp section
S. end yellow olive brown to
dark gray

Photograph:

Level:

Drawing:

Dimensions: of large section - H. (max. preserved) 12.5cm. W. of handle 5.9cm. Th. of rim: 0.5cm
Technique: of body: 0.5cm
of handle: 1.2cm

Condition: Encrusted, Fragmentary - badly burned - Poor

Description: (from PZ-81-269 PL and PZ-81-267 PL)

profile
not to scale

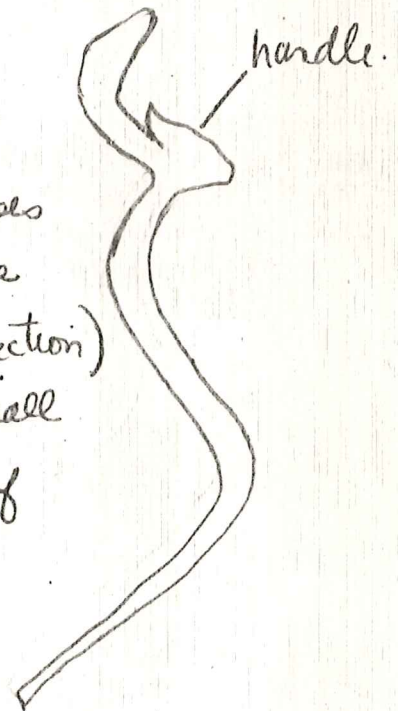

This portion of cook-pot comprises one section of 2 sherds, and the larger section (profile is of larger section) of 11 sherds. The handle is small and looks like 3 small balls of clay were applied to the top shoulder and finger-printed.

The interior and exterior of both sections is mottled black, brown, and dark orange brown. The three colors are Munsell:

5YR 2.5/2 (dark reddish brown), 5YR 4/3 (reddish brown) and 2.5YR 6/6 (light red).

Dimensions of small section: max. preserved height: 14.9cm.
width 7.1cm.

TEXAS

Date: 12 June 1981

No. 72-81-331B

Object: Bones

Material: Bone

Square: J'-1 Bath,
14 B
Ceramic Deposit

Photograph:

Level:

Drawing:

Dimensions: L.,

H.,

W.,

Th.,

Technique:

Condition:

Description:

TEXAS

Date:

12 June 1981

No. PE-81-332B

Object: Bones

Material: Bone

Square: J1-1 Batt. 15B

Photograph:

W. side

Level: Gray Br. / Dk. Gr.

Drawing:

Dimensions: L.,

H.,

W.,

Th.,

Technique:

Condition:

Description:

TEXAS

Date: 22 June 1981

No. P2-81-333B

Object: Boxes

Material: Bone

Square: NW Trench

Photograph:

Ball. 6
Level: Red-Brown

Drawing:

Dimensions: L.,

H.,

W.,

Th.,

Technique:

Condition:

Description:

TEXAS

Date: 22 June 1981

No. PE - 81 - 334 B

Object: BONES

Material: Bone

Square: N W Trench

Photograph:

Bath. 8

Level: Br. - SA w/ gravel

Drawing:

Dimensions: L.,

H.,

W.,

Th.,

Technique:

Condition:

Description:

TEXAS

Date: 12 June 1981

No. PE-81-335 P

Object: Gray Ware Theater-Mask Foot of Large Bowl Material: Pottery

Square: J 1-1 Between
Ball 13B and

Photograph:

Level: 16 D inclusive

Drawing:

Dimensions: L.,

H. (max. preserved) W.,

Th. of body: 2.7cm.

Technique:

5.3cm.

Condition:

Poor - worn + heavily encrusted

Description: (found PE-81-415 PL)

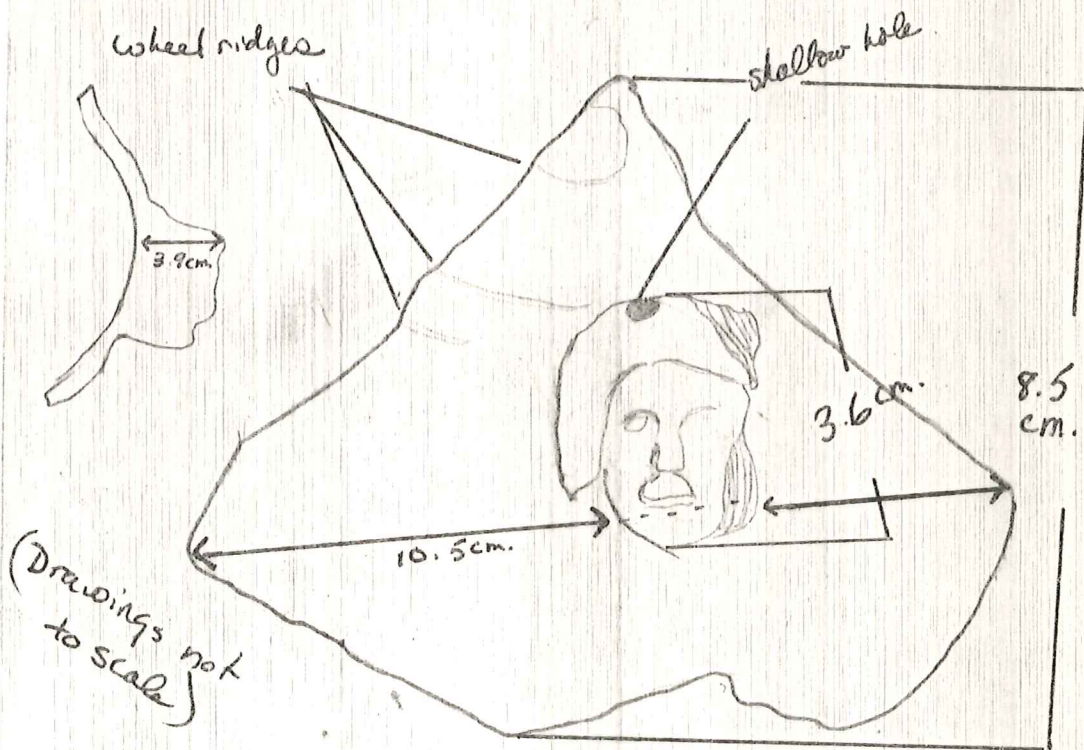

no slip present; There is a large black, carbonized spot on the interior. The features on the head are not very clearly discernable, due to wearing and encrustation.

TEXAS

Date: 12-VI-71

No. PE-81-3368 A+B

Object: 2 frags black glazed lid or rim Material: Pottery

Square: J¹-1 Batt. 14B
W. 1/2 Gray Brown

Photograph:

Level:

Drawing:

Dimensions: L.,

H.,

W.,

Th.,

Technique:

Condition: Fair - glaze worn, slightly encrusted very incomplete

Description: A+B do not join.

One large and one small piece of black glaze lid or rim. (Perhaps a plate??).

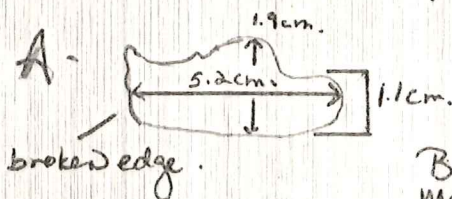

Munsell: 5YR 6/4 (light reddish brown).

Bottom not glazed.
Max. preserved diameter: 5.2 cm.

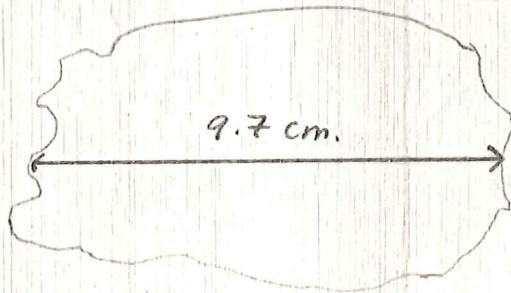

Top view
not to
scale

profile - not to scale

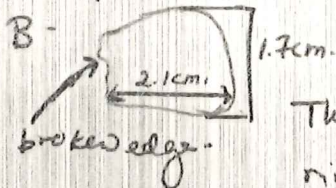

Munsell: 5YR 7/4 (Pink)
Core: 5YR 6/2 (pinkish gray).

This piece looks most like an upright rim of a large vessel or a lid edge. It is glazed on all sides but the broken side.

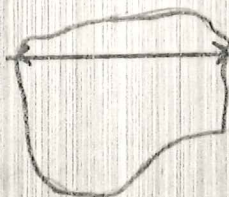

top view
actual size

TEXAS

Date: 12 June 1981

No. PZ-81-337P

Object: one body sherd - black glaze

Material: Pottery

Square: J-1 Btl. 15B

Photograph:

Ceramic W. Deposit

Level:

Drawing:

Dimensions: L.,

H.,

W.,

Th., 0.3cm.

Technique: Max. Dimensions : 2.9cm. diagonally, 2.9cm. across.

Condition: glaze is well worn. - good

Description: Munsell 5YR 7/6 (reddish yellow).

This small body sherd has very clear wheel ridging and striations on the interior and a black wave pattern on the interior.



TEXAS

Date: 12 June 1981

No. PZ-81 - 338 P-A+B

Object: Profile of Moulded Gray Ware Bowl ^{and one body sherd.} Material: Pottery

Square: J1-1 Batt. BB
Gray Brown, w/2

Photograph:

Level:

Drawing:

Dimensions: L., of A. H., max. preserved W., 7.2cm. Th., of body 0.5cm.

Technique: Thickness at highest point of moulding: 0.2cm
Condition: Fragmentary slightly worn. B. does not join
Description: A -

This piece is unusual because it is heavily decorated and has a red core. It also appears to have been very carefully covered with the usual gray slip. The core is Munsell: 5YR 6/6 (reddish yellow).

Billy Goat frieze

flying w/cape figure

dolphin

goat?
donkey?

profile - not to scale.

Satyr's head base

these bands also in relief

Palmette

Satyr's face.

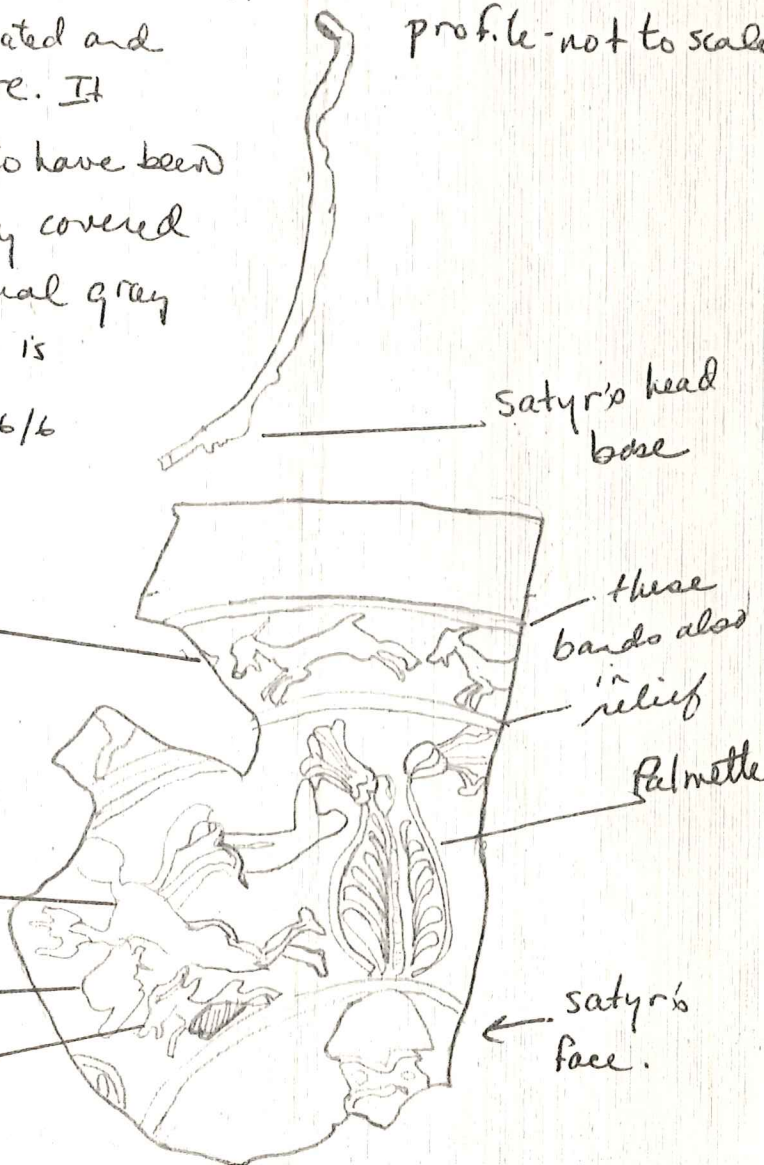

TEXAS

(cont'd)

Date: 12 June 1981

No. PE - 81 - 338 P-A+B

Object: Body sherd of moulded gray ware
section of moulded gray ware bowl.

Material: Pottery

Square: J-1 Batt. 38

Photograph:

Level: Gray Brown, W. 1/2

Drawing:

Dimensions: L., H., W., Th.,

Technique:

Condition:

Description:

B - thickness 0.3cm.

approximate size

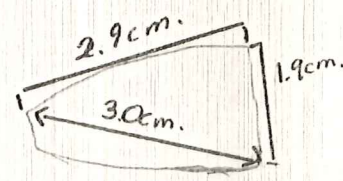
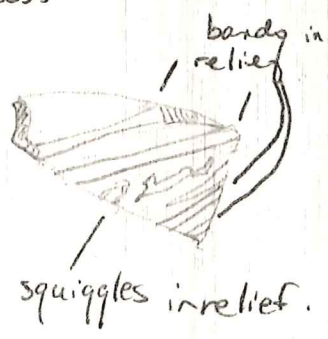

B is probably not part of the same vessel as A - the decoration seems different, and it does not have a red core.

TEXAS

Date: 12 June 1981

No. PZ-81-340P

Object: Thymateion = ^{Complete} Gray Ware Shape Material: Pottery

Square: J1-1 Batt. 138

Photograph:

W. - 1/2 Gr. Br.

Level:

Drawing:

Dimensions: L., H., 2.6 cm. W., of rim 3.0 cm. Th., of rim 2.2 cm. of bottom 2.3 cm.

Technique: Diam. at bottom 6.0 cm. Diam. at top 5.8 cm.

Condition: chipped on rim, slightly encrusted, slip worn - Fair

Description: (from PZ-81-339 PL)

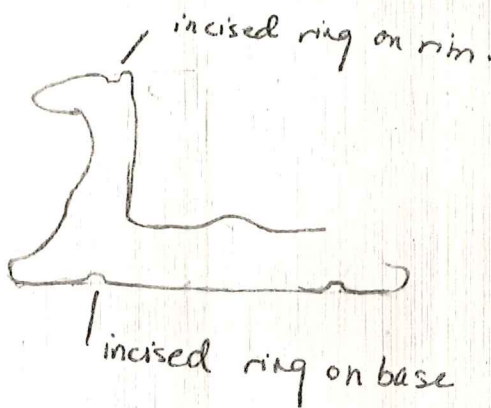

This object was slipped evenly on inside and outside.
Wheel marks are very obvious on this piece

TEXAS

Date: 12 June 1981

No. PZ-81-341P

Object: Gray Ware deep bowl

Material: Pottery

Square: J¹-1 Batt. 13B

Photograph:

w. 1/2 Gr.-Br

Level:

Drawing:

Dimensions: L.,

H., 8.4cm.

W.,

Th., of rim: 0.4cm.
of body: 0.7cm

Technique: Diam. at rim. 12.9cm.

Condition: Fragmentary - comprises 6 sherds, slightly encrusted -

Description: Basic Gray ware bowl. Deep, sides Fair curve in slightly near rim. Rim has 2 incised bands around it. Slip of the top 3.8cm. has worn away evenly, and to a greater degree than the slip below. Interior slip has a few drip marks. One blob of unsmoothed clay remains on interior near rim. There are some dots, probably air bubbles (7) near the base on the interior. Base is formed by an incised band separating it from sides of the bowl.

TEXAS

Date: 15 June 1981

No. PZ-81- 342B

Object: Boxes

Material: Bone

Square: J-1 Bath .160

Photograph:

S. end

Level: Gray to Virgin

Drawing:

Dimensions: L.,

H.,

W.,

Th.,

Technique:

Condition:

Description:

TEXAS

Date: 12-VI-81

No. PZ-81-345 P

Object: ^{Rim, neck, handle, shoulder} Storage Amphora neck ^{coarse} ware Material: Pottery

Square: J-1 Butt 16 B
West Ceramic Dep

Photograph:

Level:

Drawing:

Dimensions: L., H. (max. preserved) 21.5cm, W., max. pt. on rim. 1.7cm, Th., of handle: 2.4cm, of body: 0.5cm.

Technique: Diam. at rim: 12.9cm.

Condition: fragmentary, slightly encrusted comprises 13 frags.

Description: (From # PZ-81-344 PL)

Munsell; interior: 10R 6/4 (pale red)
exterior: 5YR 7/6 (reddish yellow).

This amphora-rim, neck, handle and beginning of shoulder is very similar in shape + size to PZ-81-347 P.

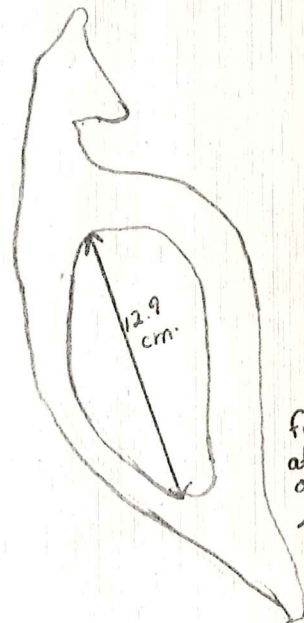

deep
finger-print
at base
of handle

TEXAS

Date: 12-VI-81

No. PZ-81-346 P

Object: 2 handled jug - coarseware

Material: Pottery

Square: J'-1 Batt. 16B
West Ceramic Deposit
Level:

Photograph:

Drawing:

Dimensions: L.,

H., (max. preserved),
13.9cm

Th., of handle:
1.8cm

Technique: interior diam. at rim - 8.2cm.

of rim: 1.0cm.

Condition: Good but fragmentary, (comprises 6 pieces.)

of body: 0.5cm.

Description: from # PZ-81-344 PL

Munsell: 5YR 7/6 (reddish yellow)

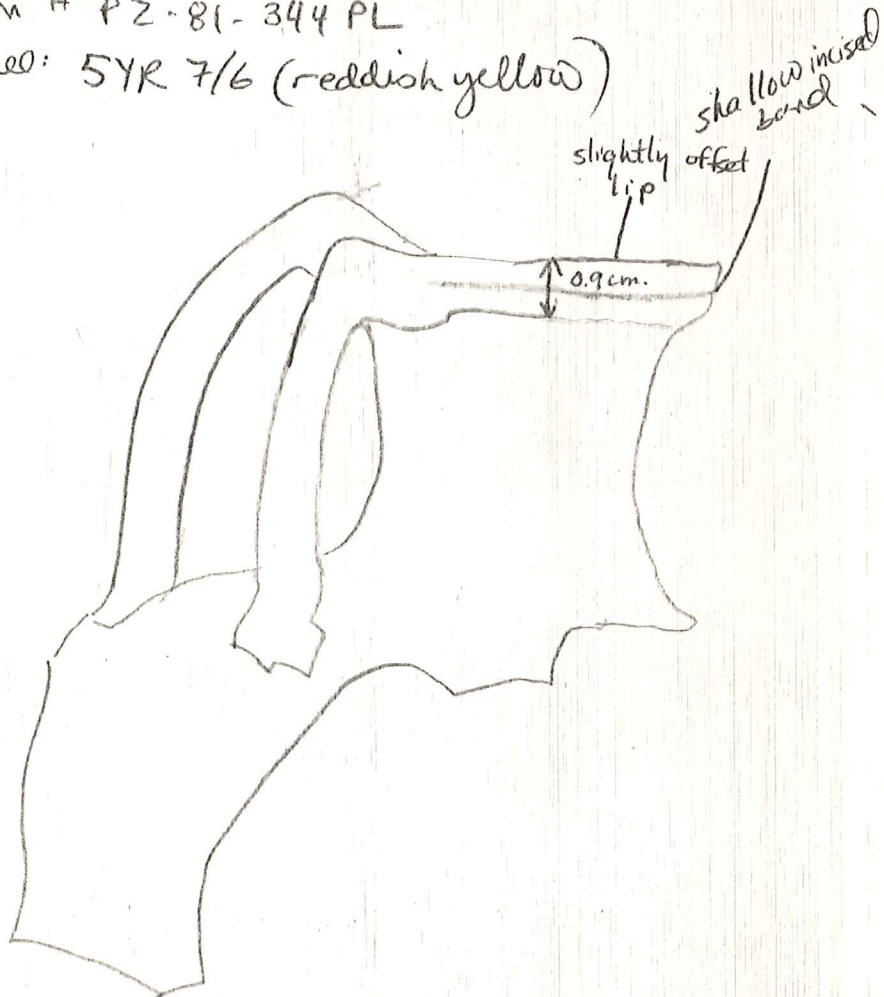

There are irregular bumps of clay
on the inside of the vessel, at the

TEXAS

Date: 12-VI-81

No. PZ-81-347 P

Object: Storage amphora neck - ^{coarse} ware Material: Pottery

Square: J1-1 Butt 16B

Photograph:

West Ceramic Deposit

Level:

Drawing:

Dimensions: L.,

H., max. preserved W.,
20 cm.

Th., of rim: 0.9
at mouth - cm.
at widest part
of rim:
2.5 cm.

Technique:

Condition: fragmentary - comprises 4 sherds - encrusted

Description: from # PZ-81-344 PL

Munsell: ext.: 5YR 7/6 (reddish yellow)
core: 5YR 6/4 (light reddish brown)

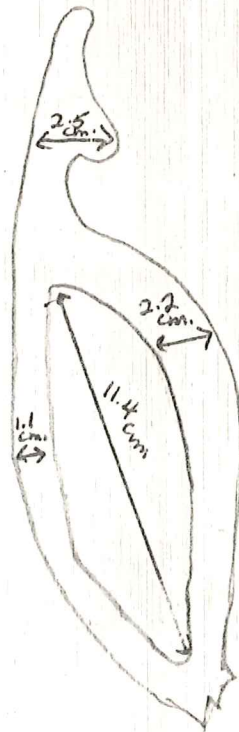

TEXAS

Date: 12 - VI - 81

No. PZ-81-349 P

Object: Gray ware neck

Material: Gray ware

Square: Bat 16 D
West Ceramic Dep

Photograph:

Level:

Drawing:

Dimensions: L.,

H., (preserved)
11.3

W.,

Th.,

Technique:

diameter at rim: 4.35 mm

Condition: fragmentary

diameter at shoulder: 7.2 mm

Description: from PZ-81-348 PL

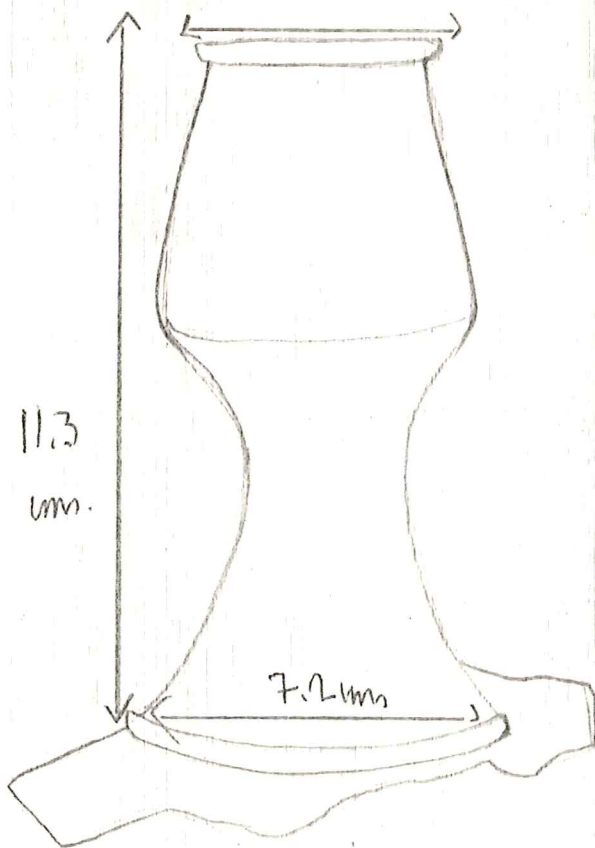

The bulb-shaped mouth of this vessel wells out gently from the out-turned rim and is offset from the neck, which wells out again down to the shoulder, from which it is divided by a raised band. The shoulder seems to have been fairly horizontal, but little of it is preserved.

TEXAS

Date: 12-VI-81

No. PZ-81-350 P

Object: orange glaze neck & rim ^{semi-fine} ^{dull ware} Material: Pottery

Square: Batt 16D

Photograph:

West Ceramic Deposit Level:

Drawing:

Dimensions: L.,

H., (max preserved) W.,

Th., of neck - 2.6cm.

Technique:

8.8cm.

at lip:
with part of rim:

Condition: Worn, weathered and fragmentary - floor - comprises 14 shreds

Description: (from PZ-81-348 PL)

Munsell: fabric: 5YR 7/6 (reddish yellow).
glaze: 2.5YR 5/8 (red).

unusual, glazed
area - seems to have
finger impressions

NOT TO SCALE

Profile



The orange glaze covered all the areas which were visible, and dripped down inside the neck. The interior of the neck has very prominent wheel ridges

TEXAS

Date: 12-VI-81

No. PZ-81-351 P

Object: Banded neck - black glaze

Material: Pottery

Square: Balt 16D

Photograph:

West Ceramic Dep
Level:

Drawing:

Dimensions: L.,

H.,

W.,

Th., at top: 1.1cm.

Technique:

at bottom

Condition: weathered and worn - poor; - along good - vessel encrusted.
1.6cm.

Description: From # PZ-81-348 PL

Munsell: fabric 5YR 7/1 (reddish yellow)
: red glaze 10R 6/8 (red).

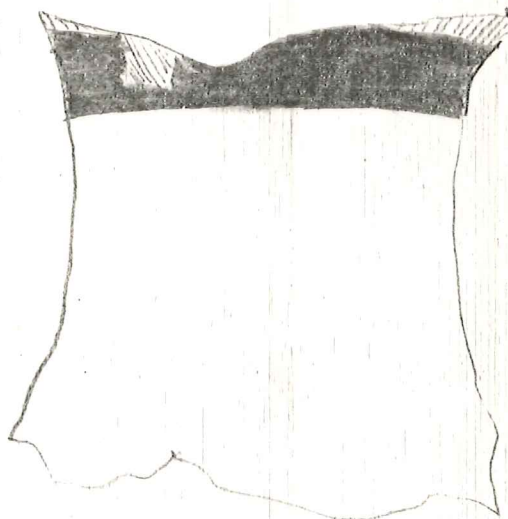

There are some blackish brown marks, with
and on the incrustations on the exterior.
The red glaze was applied only on the
outside beneath the black glaze.

TEXAS

Date: 12-VI-81

No. PZ-81-352 P

Object: table ware lid - coarseware

Material: Pottery

Square: Butt CG D
West Ceramic Dep

Photograph:

Level:

Drawing:

Dimensions: L.,

H., 3.7cm.

W.,

Th., at edge.
0.6cm.

Technique: diam., 9.8cm. diam. of knob: 2.1cm.

Condition: good but chipped + encrusted

Description: (From # PZ-81-348 PL)

Munsell: underside: + top - 5YR 7/4 (pink),

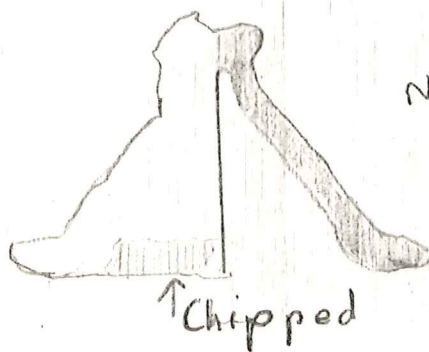

NOT TO SCALE

TEXAS

Date: 12-VI-81

No. PZ-81-353P

Object: coarse ware neck - short + narrow - Material: Pottery

Square: Balt 16 D

Photograph:

West Ceramic Dep

Level:

Drawing:

Dimensions: L.,

H., (max. preserved) W.,

Th. of handle:
3.2cm.

Technique: interior diam. at rim: 4.5cm.
5.2cm.

Condition: encrusted - fragmented - worn - Poor

Description: (From # PZ-81-348 PL)

Fabric has small white inclusions.

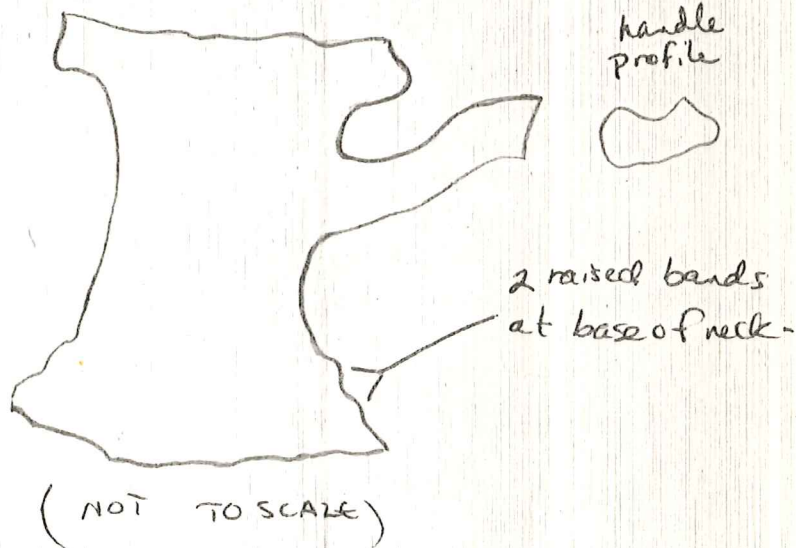

Munsell: fabric: 2.5YR 6/8 (light red),
glaze: 2.5YR 4/8 (red)

Glaze remains in small patches on rim and handle. There is no trace of glaze on the interior

TEXAS

Date: 12-VI-81

No. PZ-81-354 P

Object: coarse ware neck and handle

Material: Pottery

Square: BAH 16 D
West Ceramic Dep.
Level:

Photograph:

Drawing:

Dimensions: L.,

H., (max preserved) W.,

Th., of handle
1.6cm.

Technique: Interior diam. at rim: 8.5 cm.

of Rim: 0.9

Condition: worn and fragmentary-encrusted - Good

of body: 0.6cm.

Description: From # PZ-81-348 PL

also see PZ-81-353P for similar smaller neck.

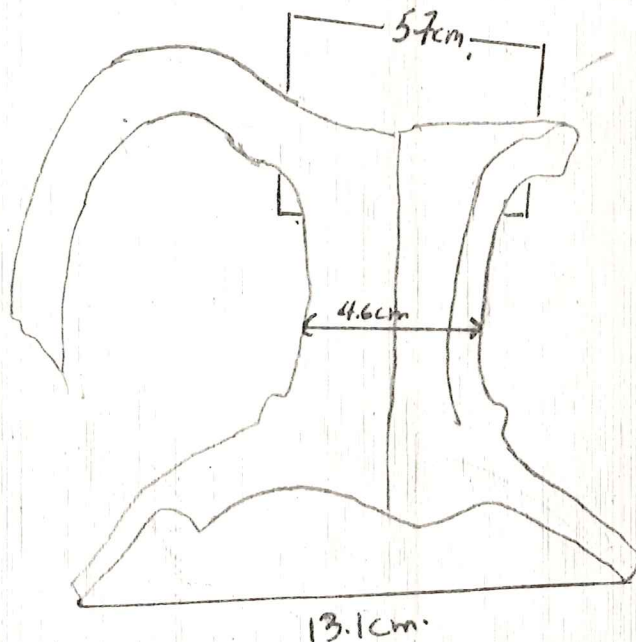

Munsell: 5YR
7/8 (reddish yellow)

TEXAS

Date: 12 June 1981

No. PE-81 - 355P

Object: Thin Coarse Ware Narrow Neck Jug Material: Pottery

Square: J'-1 Batt. 13B
W. 1/2 G.C.-Br.

Photograph:

Level:

Drawing:

Dimensions: L.,

H.,

W.,

Th.,

Technique:

at neck 0.5 cms.
body 0.45 cms.

Condition: fragmentary but otherwise good.

Description: (from PE-81-339P)
(+ 2 pieces from PL 359.)

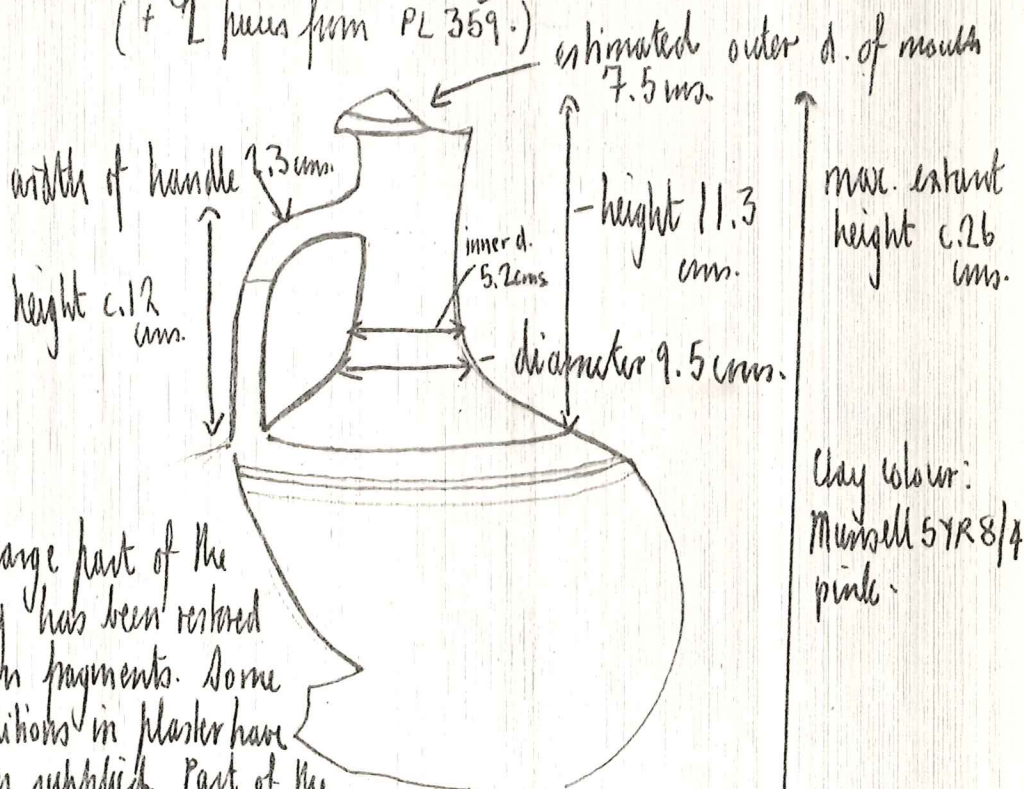

a large part of the jug has been restored from fragments. Some additions in plaster have been supplied. Part of the ring base survives separately (glued from 3 fragments) and there are four loose fragments which have not been attached.

This jug is of an extremely elegant shape, with a long, narrow neck, slightly flaring mouth with down-turned rim, gently sloping shoulders which are sharply offset from the bulbous, swelling body, and small foot (int. diameter c. 9.7 cms). The shoulder is decorated with incised bands, and there are traces of orange red glaze adhering to it + to the lower neck. Fabric is coarse but thin + the vessel is carefully worked.

TEXAS

Date: 12 June 1981

No. PE-81 356P

Object: Body sherd of moulded ^{gray} ware Material: Pottery

Square: J¹-1 Bath. 13.9
W. 1/2 Gr.-Br.

Photograph:

Level:

Drawing:

Dimensions: L.,

H.,

W.,

Th., 0.6cm.

Technique:

Condition: Good - slip well preserved, sherd is not scratched

Description: (from PE-81-339P)

Moulding is well preserved.
There are 2 very full,
rounded leaves
on this body frag.
The leaves most
resemble oak leaves.

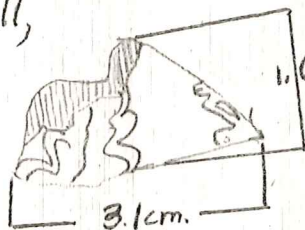

actual size

TEXAS

Date: 12 June 1981

No. PZ-81-357P

Object: Gray-ware bowl rim fragments

Material: Pottery

Square: J¹-1
W. Ceramii deposit

Photograph:

Level: Batt 16D

Drawing:

Dimensions: L.,

H., from rim to base 2.4.

W.,

Th., 0.35 - 0.55 mm.

Technique:

Condition:

fragmentary, worn.

Description:

from PE-81-348PL

The fragment comes from a large, flat bowl, with short, off-set rim.

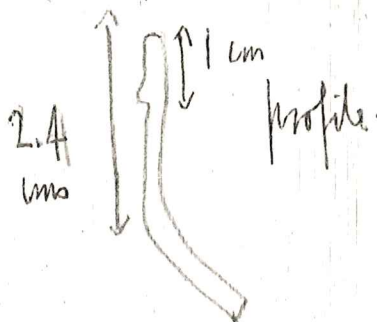
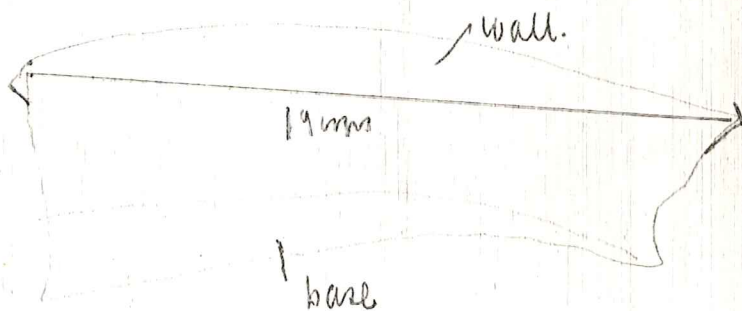

TEXAS

Date: 12 June 1981 No. PZ-81-358P

Object: Gray-ware bowl fragments Material: Pottery

Square: J1-1 Photograph:

W. ceramic deposit

Level: Batt 16 D Drawing:

Dimensions: L., H., from rim to base, W., Th., of base
4.65 0.65 mm
of wall

Technique:

Condition: fragmentary + unsorted.

0.37 mm

Description: (from PZ-81-348P2)

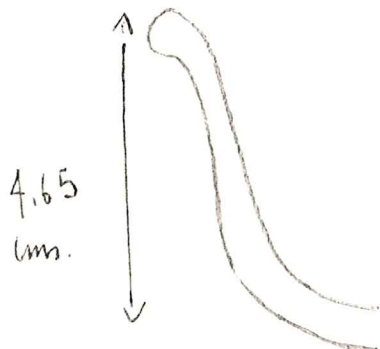

fragment of shallow bowl with flat base and short, out-flared rim.

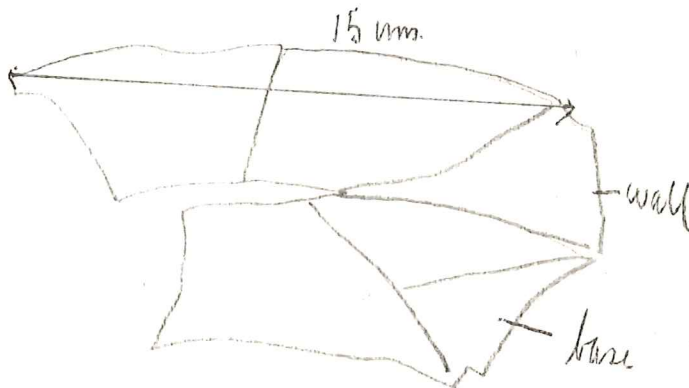

TEXAS

Date: 30 June 1981

No. PE-81-360P

Object: body sherd Archaic red figure Material: Pottery

Square: well trench
Batt. 1 M1-5

Photograph:

Level: Area of Archaic
Spring

Drawing:

Dimensions: L.,

H.,

W.,

Th., 0.4cm.

Technique:

Condition: Friable, but in good condition

Description: sherd is glazed solid black on interior. Interior wheel ridging is distinct. The figure seems to have both arms spread out, front and back. He is very likely an athlete.

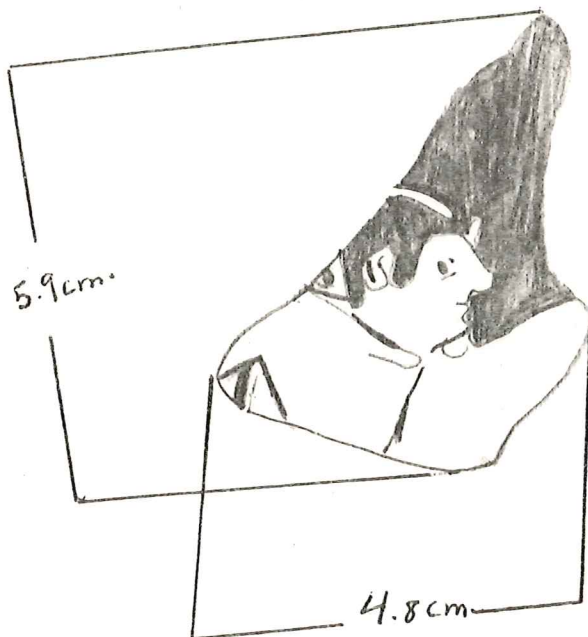

(actual size)

Munsell: 5YR 5/6 Yellowish Red.

TEXAS

Date: 12 June 1987

No. PZ-81-361P

Object: Base of gray ware bowl, moulded

Material: Ceramic

Square: J¹-1 Butt 14B
Ceramic deposit

Photograph:

Level:

Drawing:

Dimensions: L.,

Estimated d. of base if complete i. b. 7 mm.

H.,

W.,

Th., at edge, 0.2 mm

Technique:

Condition: Worn and cracked.

Description:

(from PZ-81-359 PL)

About two thirds of the base is preserved. Within two raised ridges the decoration consists of a central motif, around which are set three natyr heads which form the feet of the vessel, and three rays of leaves, which overlap the raised ridges. The natyr are shown grinning, and one of them appears to have leaves in his hair.

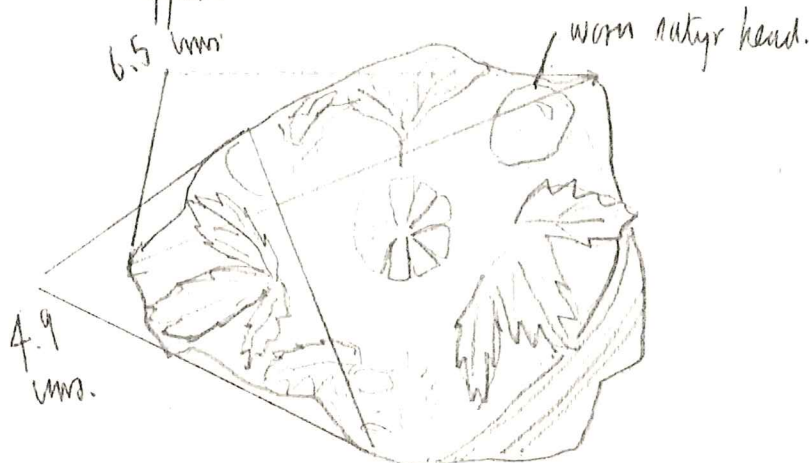

TEXAS

Date: 12 June 1981

No. PZ-87-362T

Object: Tile fragment

Material: Terraotta.

Square: J1-7 Batt 14B
ceramic deposit

Photograph:

Level:

Drawing:

Dimensions: L.,

H.,

W.,

Th. mmc.

Technique:

Thickness 2.2mm
at thin

Condition: Fair - mounted in parts.

Description:

(from PZ-87-359 PL)

raised border,

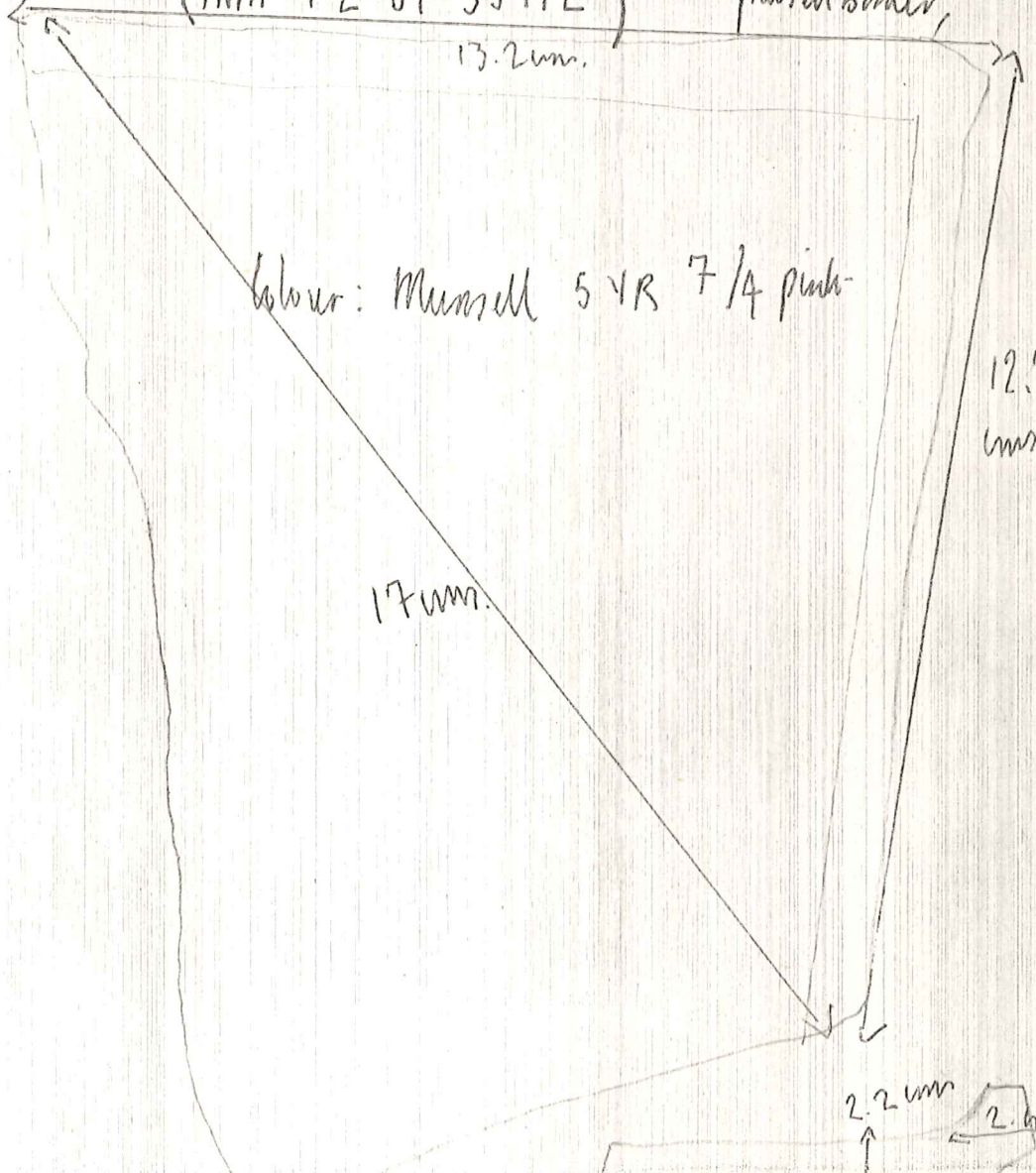

TEXAS

Date: 12 June 1981

No. PZ-81-363T

Object: Tile fragment

Material: Terra Cotta

Square: J-1 Batt 14 B
Ceramic deposit.

Photograph:

Level:

Drawing:

Dimensions: L., 17.5 cm

H., 1

W., 16 cm

Th., 3.4 on rim
1.6 elsewhere.

Technique:

Condition: chipped and with some excavation.

Description:

(from 359 PL)

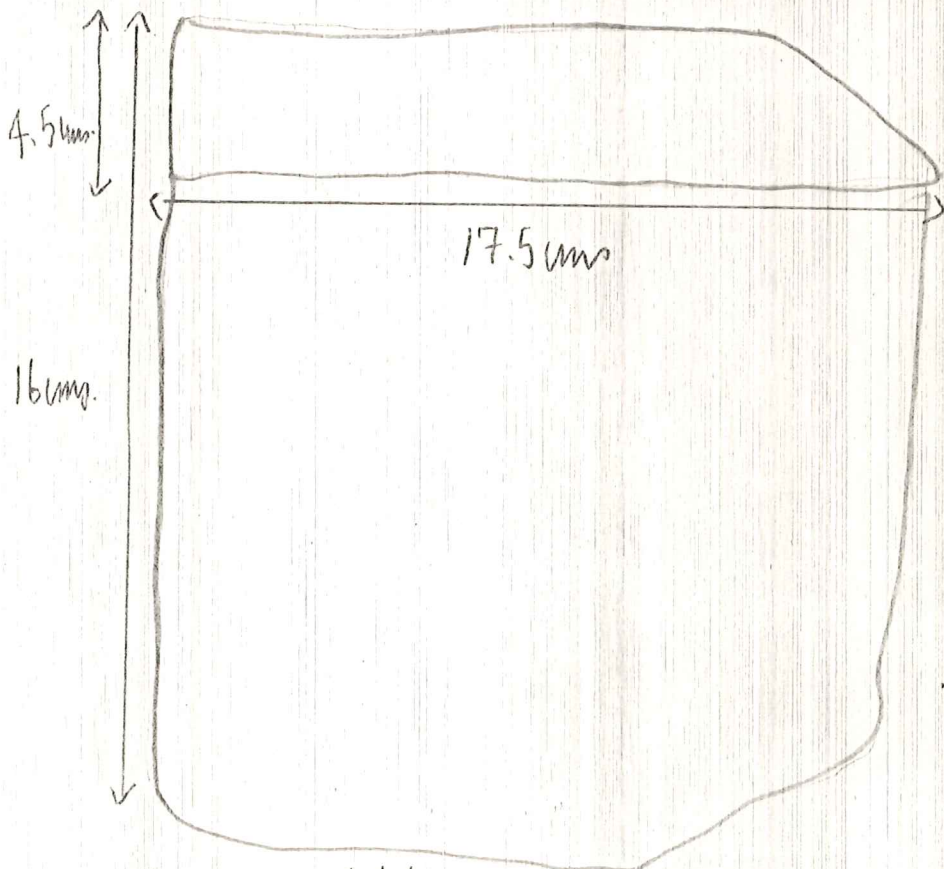

Probably a tomb tile. Raised rim along one edge only.

TEXAS

Date: 30 June 1981

No. PZ-81-364 P

Object: Votive Cup ^{semi-fine.}
fabric-worn orange slip Material: Pottery

Square: Well Trench
Bott. 2 M¹-5

Photograph:

Level: Area of Archaic
Spring

Drawing:

Dimensions: L.,

H., 3.7cm.

W.,

Th., at rim: 0.3
cm.

Technique: Diam. of base: 2.8cm.

of handle: 0.6
cm.

Condition: Encrusted; slip well worn. Cracked - Fair.

Description: This little vessel is cracked through the rim
on 2 sides. Vessel mouth is not round. Max. diam.
is 3.8cm. Min. diam. is 3.1cm. Slip is best
preserved on and around handles.

Munsell: fabric: 5YR 8/4 (pink).

Slip: 5YR 6/8 (reddish yellow).

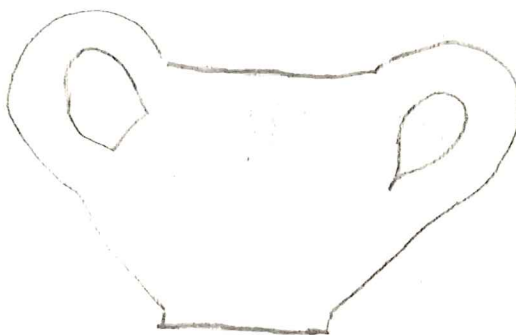

TEXAS

Date: 12 June 1981

No. PE-81-366B

Object: Bones

Material: Bone

Square: J¹-1 Batt. 14B
w. 1/2 Gs. B2.

Photograph:

Level:

Drawing:

Dimensions: L.,

H.,

W.,

Th.,

Technique:

Condition:

Description:

TEXAS

Date: 12 June 1981

No. 72 - 81 - 367 ~~M~~

Object: Metal Slag Chunks

Material: Metal Slag

Square: J¹-1 Batt. 14B

Photograph:

w. 1/2 Oz. - Br.

Level:

Drawing:

Dimensions: L.,

H.,

W.,

Th.,

Technique:

Condition:

Description:

TEXAS

Date: 12th June 1981

No. PZ-81-368P

Object: Storage jar neck, handle + shoulder

Material: Pottery

Square: J-1 Buth 14B
Ceramic deposit

Photograph:

Level:

Drawing:

Dimensions: L.,

H., Total height 21.5
cms

W., Diameter of
neck 10.2cm

Th., of body 0.8cm
of neck 1.1cm

Technique:

Condition:

Height to base of
handle 17cms.

Description:

(from 359 PL)

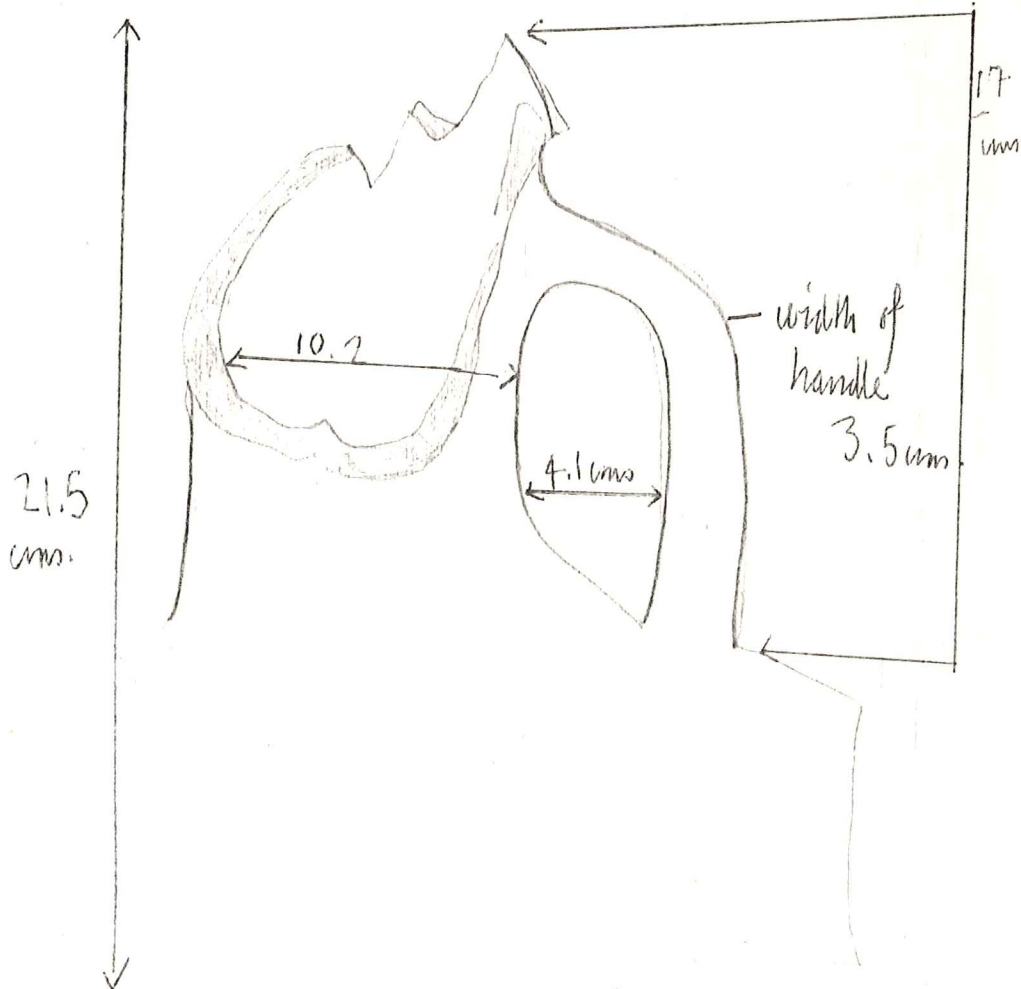

TEXAS

Date: 12-11-81

No. PZ-81-370B

Object: Bone

Material: Bone

Square: J¹-1 Box 14 B
East 1/2 grey Br/Dk
Level: Sr-Br.

Photograph:

Drawing:

Dimensions: L.,

H.,

W.,

Th.,

Technique:

Condition:

Description:

From # PZ-81-369 PL

TEXAS

Date: 12 June 1981 No. PZ-81-371P

Object: Gray Ware lamp ^{no spout} ^{no handle} Material: Pottery

Square: J¹-1 Batt. 158 Photograph:
New Deposit Drawing:
Level: SE Square

Dimensions: L., 0 H., 3.7cm. W., Th., abs. spout:
Technique: Diam. of base - 3.9cm 0.7cm

Condition: Poor - worn, handle + spout missing
Description:

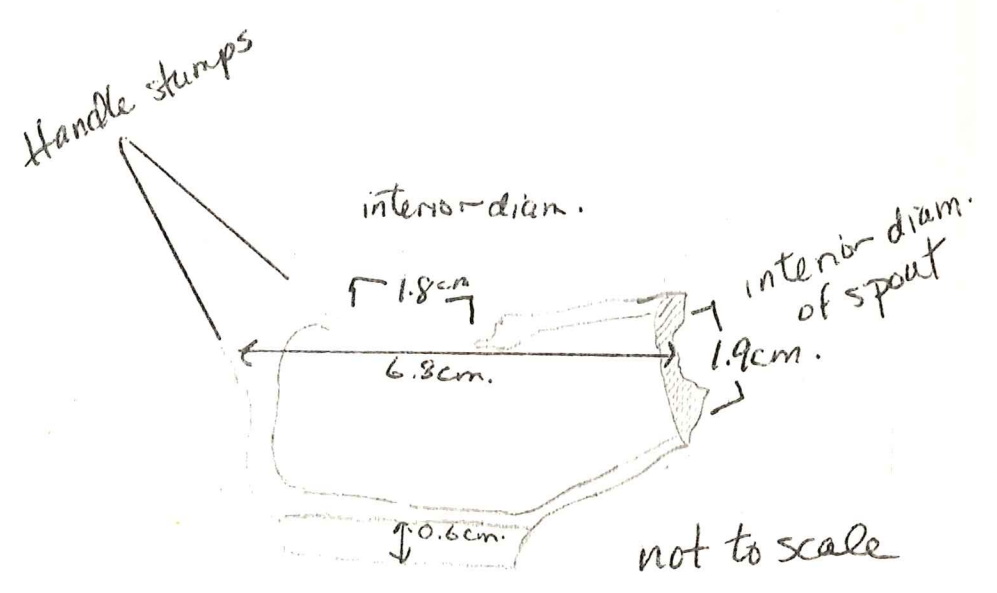

TEXAS

Date: 12-VI-81

No. PZ-81-37ZM

Object: 2 pieces of slag

Material: Slag

Square: J'-1 Bath 14 B

Photograph:

Level: East 1/2
Grey Brown/DK SL BR

Drawing:

Dimensions: L.,

H.,

W.,

Th.,

Technique:

Condition:

Description: From # PZ-81-369 PL

One big and one small piece of slag

TEXAS

Date: 12-VI-81

No. PZ-81 - 373 P.A+B

Object: Gray Ware Bowls

Material: Pottery

Square: J-1 Box 14B

Photograph:

Ceramic Deposit

Level:

Drawing:

Dimensions: L.,

H.,

W.,

Th.,

Technique:

Condition: Poor-chipped and deteriorating.

Description: 15 Fragments. Not all are from same vessel. 3 sherds are from a shallow bowl (A) the 12 sherds in the worst condition are from a deep bowl (B). B's frags are darker gray as well.

A - max preserved ht: 5.4cm.
thickness: 0.6cm.
thickness of rim: 0.3cm.



B - Thickness: 0.3cm. max. preserved diam: 8.5cm.



Ring-foot base
diam. - 5.3cm.

TEXAS

Date: 12-VI-81

No. PZ-81-374 P

Object: Orange + Gray ware Deep bowl

Material: Pottery

Square: J-1 BAH 14B
gray brown dk sr Br

Photograph:

Level:

Drawing:

Dimensions: L.,

H.,

W.,

Th.,

Technique:

Condition: fair

Description: from PZ-81-369 PL

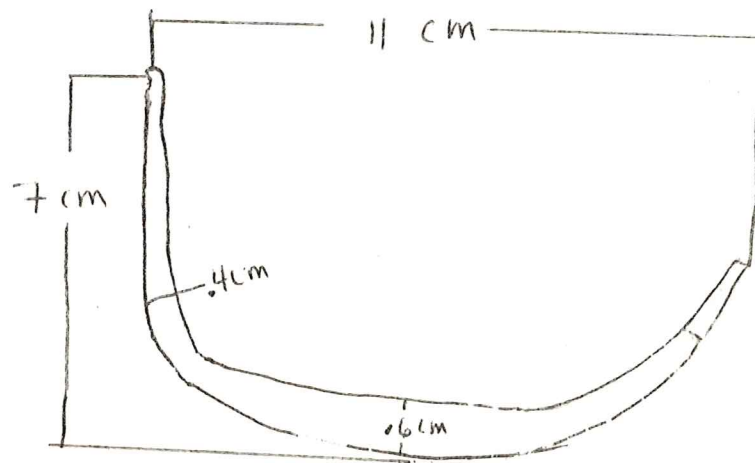

Deep orange and gray glazed bowl with
incised base - slip irregular.

TEXAS

Date: 12 June 1981

No. PZ-81-375P

Object: Body sherd - black glaze Red Figure? Ivy Leaf? Pallyn ???
Material: Pottery

Square: J¹-1 Batt. 13B

Photograph:

Gray-Brown

Level: S. West Side

Drawing:

Dimensions: L.,

H.,

W.,

Th., 0.5cm.

Technique:

Condition: Slightly excavated - red glaze worn. Good

Description: Solid black glaze on inside. Black design on red on outside:

Munsell: Red glaze: 10R 5/8 (red).

Core: 5YR 7/6 (reddish yellow).
4.1cm.

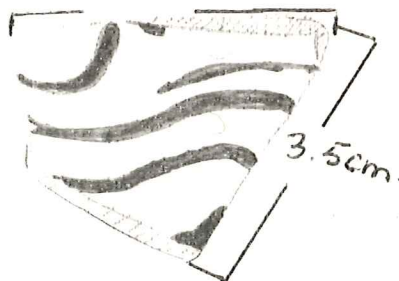

TEXAS

Date: 12 June 1981

No. PE - 81 - 376P

Object: Small Coarse Ware Mortarium.

Material: Ceramic

Square: J¹-1 Batt. 148

Photograph:

Ceramic Deposit

Level:

Drawing:

Dimensions: L.,

H., 15.8cm.

W.,

Th.,

Technique:

Condition: Rough + encrusted. - Good.

Description: (from PE - 81 - 359P).

One half of it remains. The fabric has large dark inclusions.

Munsell - fabric: 5YR 7/6 (reddish yellow).

inclusions: 5YR 5/4 (reddish brown).

There are some blackened spots on the interior, at the rim and near the bottom.

There are faint grinding marks.

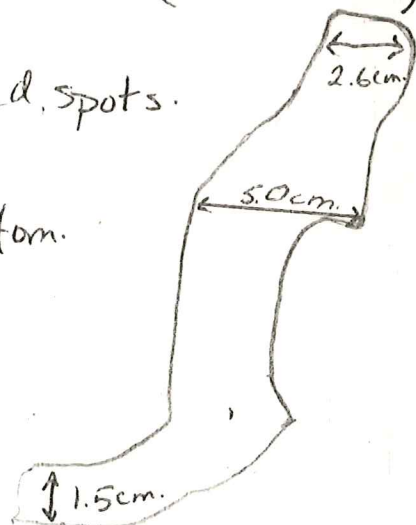

TEXAS

Date: 12-VI-81

No. PE-81- 378B

Object: Bones

Material: Bone

Square: J¹-1 Bath. 14B

Photograph:

E. 1/2

Level: Gr-B.

Drawing:

Dimensions: L.,

H.,

W.,

Th.,

Technique:

Condition:

Description:

TEXAS

Date: 12 June 1981

No. PE-81-379M

Object: Slag

Material: Metal Slag

Square: J-1 Batt. 14B

Photograph:

E. 1/2 Gr-B:

Level:

Drawing:

Dimensions: L.,

H.,

W.,

Th.,

Technique:

Condition:

Description:

TEXAS

Date: 12-VI-81

No. PE-81 - 380M

Object: Slag

Material: Metal Slag

Square: J'-1 Batt. 13B

Photograph:

Q. 1/2 Grayish

Level: Brown

Drawing:

Dimensions: L.,

H.,

W.,

Th.,

Technique:

Condition:

Description:

TEXAS

Date: 24 June 1981

No. PZ-81-38355

Object: Soil Sample

Material: Varied

Square: N W Trench
Ceramic Dep.

Photograph:

Level:

Drawing:

Dimensions: L.,

H.,

W.,

Th.,

Technique:

Condition:

Description:

TEXAS

Date: 19 June 1981

No. PE-81-384M

Object: Metal Slag

Material: Slag

Square: NW Trench
Batt. 5
Mottled Burnt Red
Level: ctr. Trench

Photograph:

Drawing:

Dimensions: L.,

H.,

W.,

Th.,

Technique:

Condition:

Description:

TEXAS

Date: 1 July 1981

No. 72-81-385P

Object: Italo? Corinthian ^{Bowl} ^{Shed}

Material: Pottery

Square: Well Trench
Spring Sect. 2

Photograph:

Level:

Drawing:

Dimensions: L.,

H. (max. preserved) W.,
5.5 cm.

Th. on base: 0.2 cm
ct. of shed: 0.4 cm

Technique:

Condition: Good - Design very legible. Slight encrustations.

Description: From a squat lekythos?

Munsell: fabric - exterior 2.5Y 8/2 (white) Profile - not to scale.
- interior 5YR 8/4 (pink)
paint colors - 10YR 4/4 (dark yellowish brown - gold in drawing)
10R 4/6 (red) = red pen in drawing.

Cows and rosettes in 3 colors (including black). Details etched into the surface.

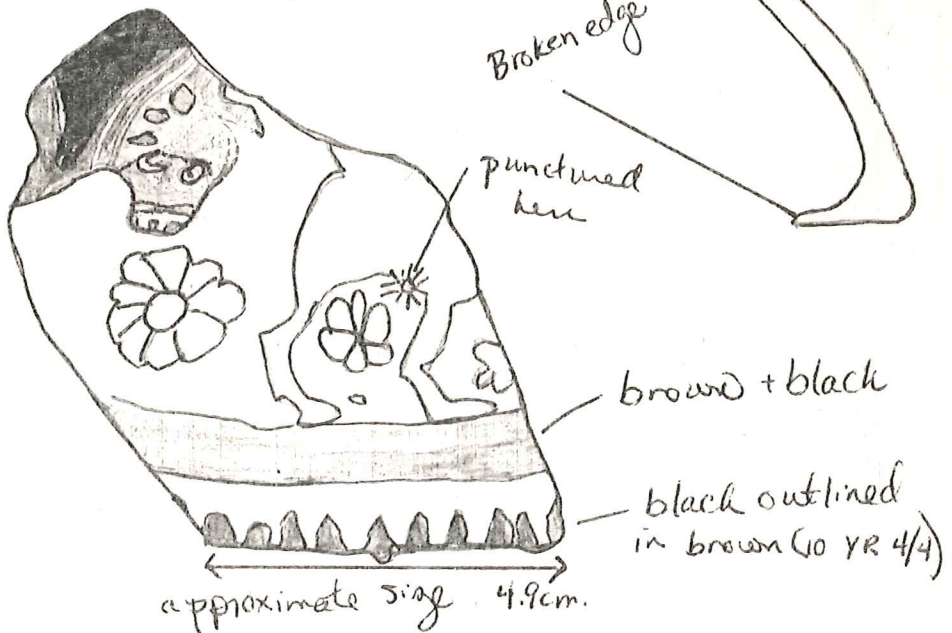

TEXAS

Date: 19 June 1981

No. 72-81-386B

Object: Bones

Material: Bones

Square: NW Trench

Photograph:

Batt. 5
Mottled Burnt Red

Drawing:

Level: Ctr. Trench

Dimensions: L.,

H.,

W.,

Th.,

Technique:

Condition:

Description:

TEXAS

Date: 23 June 1981 No. PE-81-387M

Object: ^{Roman} Republican Coin Material: Metal - Bronze

Square: NW Trench Photograph:

Batt. 9 W.

Level: Yellow Brown Drawing:

Dimensions: L., H., W., Th., 0.4cm.

Technique: Diam. 2.8cm.

Condition: Barely legible - Poor

Description:
Design of Ships prow on one side, having an "MA"
above it. Possibly an "O" next to the "A".

Other side: ? Standing Zeus? Stick Figure,
which is said or thought to be a Zeus.

Weight 0.19650

Semis of 148 B.C.?
of Crawford RRC 215

TEXAS

Date: 12 June 1981

No. PE - 81 - 388P

Object: Gray Ware ^{neck,} handle, and ring foot Material: Pottery

Square: J1-1 Bath. 14B
Ceramic Dep.

Photograph:

Level:

Drawing:

Dimensions: L.,

H.,

W.,

Th.,

Technique:

Condition: Poor-fragmentary + worn + encrusted

Description: These 3 fragments do not join.

They are small, and not very complete shapes

There are also 2 chips - tiny.

TEXAS

Date: 12 June 1981

No. PZ-81-389M

Object: Bronze Coin

Material: Bronze

Square: J-1 Batt.

Photograph:

15B dk. gray w.

Level: S. side
9m. N-X.3E

Drawing:

Dimensions: L.,

H.,

W.,

Th.,

Technique:

Condition: Illegible.

Description:

Coin is illegible.

Max. Diam. is 3.2cm.

Th. is 0.4cm. at ctr.

TEXAS

Date: 12 June 1981

No. PZ-81-390B

Object: Bones

Material: Bone

Square: J-1 Batt. 15B

Photograph:

W. Ceramic Dep.

Level:

Drawing:

Dimensions: L.,

H.,

W.,

Th.,

Technique:

Condition:

Description:

TEXAS

Date: 12 June 1981

No. PZ-81-391B

Object: Boxes

Material: Bone

Square: J-1 Box 15B

Photograph:

New Deposit

Level: Cer.

Drawing:

Dimensions: L.,

H.,

W.,

Th.,

Technique:

Condition:

Description:

TEXAS

Date: 12 June 1981

No. PZ-81 - 392B

Object: Boxes

Material: Bone

Square: J¹ - 1 Batt. 15B
Gray - Br/Dk. q. br

Photograph:

Level:

Drawing:

Dimensions: L.,

H.,

W.,

Th.,

Technique:

Condition:

Description:

TEXAS

Date: 12 June 1981

No. PE - 81 - 393 P

Object: Gray Ware Trefoil Oenochoe Material: Ceramic

Square: J^o - 1300.HH

Photograph:

SE Deposit

Level:

Drawing:

Dimensions: L.,

H., max. 15.7cm. W.,

Th., of handle:

Technique: Diam. of base: 6.2cm.

0.6cm.
of rim 0.4cm.

Condition: Good - Freshly Chipped. Comprises 37 sherds.

Description:

Slip is well preserved. Applied $\frac{2}{3}$ of the way down from mouth on exterior. On interior, slip goes down only $\frac{1}{2}$ way on neck - interior not slipped. 2 incised bands decorate the base of the neck. There is an incised band, wider than the 2 at neck-base around the inside of the trefoil mouth. Handle is a strap handle with 2 raised ridges. Foot is a ring. Overall-shape is squat and round.

There are 5 body sherds which do not join accompanying this vessel.

TEXAS

Date: 12 June 1981

No. PE-81-394B

Object: Bones

Material: Bone

Square: J1-1 Batt. 158

Photograph:

W. 1/2 W. Dep.

Level: Dk. Gray

Drawing:

Dimensions: L.,

H.,

W.,

Th.,

Technique:

Condition:

Description:

TEXAS

Date: 1 July 1981

No. PZ-81-395 P

Object: Red Figure Body Sherd

Material: Pottery

Square: Well Trench
Spring Sect. 2

Photograph:

Level: NW Corner

Drawing:

Dimensions: L.,

H.,

W.,

Th., 2.3cm.

Technique:

Condition:

Description: Fabric-body + core - unsealed: 5YR 6/4 (light reddish brown).

Nude, seated? male. The sherd is in a good state of preservation. There is one deep, V-shaped scratch. Glaze is even on back.

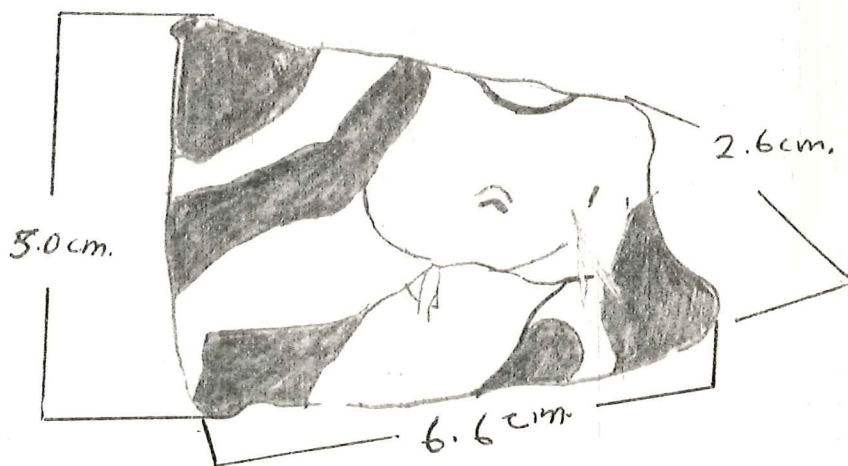

Approximate size.

TEXAS

Date: 12 June 1981

No. PZ-81-396 MA+B

Object: Metal 2 - frags. of rails Material: Slag-Iron

Square: J-1 Bath-15B

Photograph:

W. side Gray-Brown

Level: Dk. Gray

Drawing:

Dimensions: L.,

H.,

W.,

Th.,

Technique:

Condition: poor, fragmentary + rusted - no heads preserved.

Description:

A - diam: 1.2cm.

length: 5.2cm.

B. diam. 1.2cm.

length 5.8cm.

TEXAS

Date: 12 June 1981

No. PZ-81-397m

Object: Metal frag. - flat and thin

Material: S. Iron

Square: J-1 Batt. 15B
w. ceramic
deposit

Photograph:

Level:

Drawing:

Dimensions: L.,

H.,

W.,

Th., max. 1.0cm.
min. 0.4cm.

Technique:

Condition: Heavily corroded - Poor

Description:

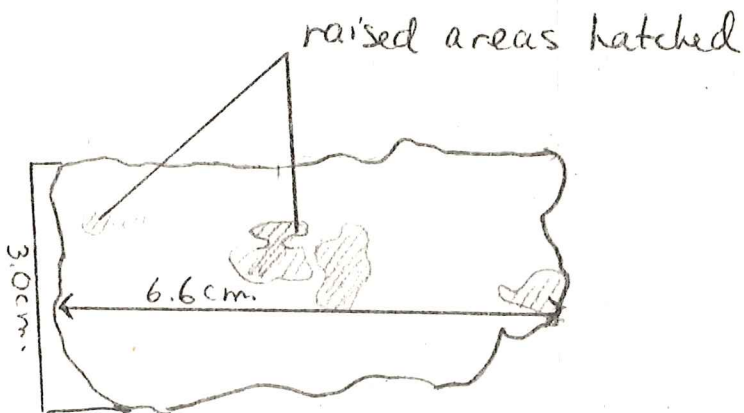

Not certain what this was - but it's
not slag.

TEXAS

Date: 15 June 1981

No. PZ-81-398 m

Object: Metal slag

Material: Slag

Square: J-1 Batt. 15B
New Deposit-CER.

Photograph:

Level:

Drawing:

Dimensions: L.,

H.,

W.,

Th.,

Technique:

Condition:

Description:

TEXAS

Date: 19 June 1981 No. PZ-81-399 M^{A,B,C}.

Object: Metal slag, nail frag, projectile point? Material: slag Iron

Square: NW Trench
Red- Br- SA
E. to center
Level: Batt. 5

Photograph:

Drawing:

Dimensions: L., H., W., Th.,

Technique:

Condition:

Description: A - looks like slag.

B - Was an iron nail - very lumpy and corroded; gray clay clinging to it

max. preserved ht: 4.9cm.

max. preserved diam. of head: 3.3cm.

C - looks like 1/2 a spear point

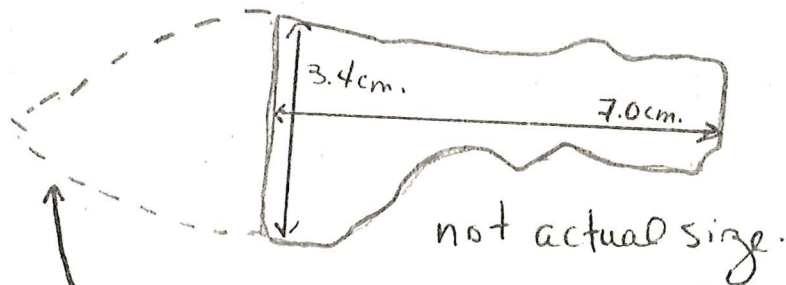

dotted lines are an extrapolation from the existing portion of the object.

It appears to be iron, very bumpy and rusted.

TEXAS

Date: 24-VI-81

No. PZ-81-400P

Object: Amphora

Material: Pottery

Square: NW Trench
Ceramic Deposit

Photograph:

Level: level 2

Drawing:

Dimensions: L.,

H.,

W.,

Th.,

Technique:

Condition: excellent. Fragmented

Description:

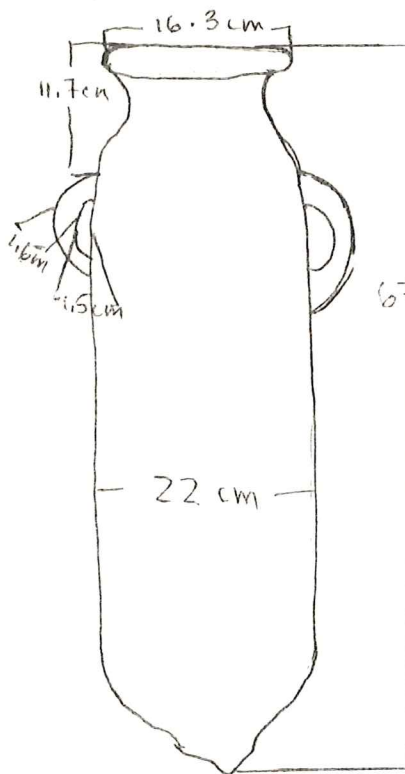

Large storage amphora of a type frequently used for holding oil. The shape is common to amphorae found in Palestine as well as in Carthage where they date from the late 2nd - early 1st century B.C. John Hayes says that due to its short neck, this amphora is an early example from this period.

approx. thickness 0.6 cm.

Munsell 5YR 8/2 pinkish white

TEXAS

Date: 23 June 1981

No. PZ-81-401m

Object: Metalslag

Material: Slag

Square: NW Trench
Batl. 9 W. Ramp
Yellow Br./Br.
Level:

Photograph:

Drawing:

Dimensions: L.,

H.,

W.,

Th.,

Technique:

Condition:

Description:

TEXAS

Date: 12 June 1981

No. PZ-81-402B

Object: Boxes

Material: Boxes

Square: I 1 - 1 Batt. 15B
W. side W. Dep.

Photograph:

Level: Dk. Gray

Drawing:

Dimensions: L.,

H.,

W.,

Th.,

Technique:

Condition:

Description:

TEXAS

Date: 19 June 1981

No. PZ-81-403B

Object: Boxes

Material: Bone

Square: NW Trench
Batt. 5 Red-Br. Sil
E. to Ctr.
Level:

Photograph:

Drawing:

Dimensions: L.,

H.,

W.,

Th.,

Technique:

Condition:

Description:

TEXAS

Date: 23 June 1981

No. PZ-81-404B

Object: Bones

Material: Bone

Square: NW Trench

Photograph:

Batt. 10 N. side

Level: to Tile Fall

Drawing:

Dimensions: L.,

H.,

W.,

Th.,

Technique:

Condition:

Description:

TEXAS

Date: 12th June 1981

No. PZ-81-405P

Object: Moulded gray ware fragment

Material: Ceramic

Square: J-1 Butt 14B

Photograph:

Level: Dark gray old deposit

Drawing:

Dimensions: L.,

H.,

W.,

Th.,

Technique:

Condition: Very worn and weathered - fragmentary

Description:

(from 382PL)

One gray ware fragment. decoration is vaguely visible and thus indistinguishable.

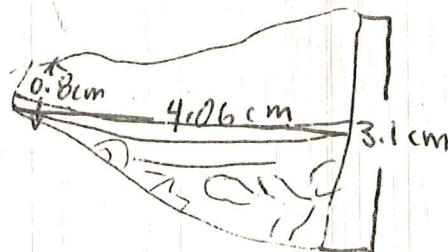

approx thickness
0.3 cm

TEXAS

Date: 12 June 1981

No. PZ-81-407P

Object: Moulded gray ware rim

Material: Pottery

Square: J-1 Bath, SB
New Deposit. Cer

Photograph:

Level:

Drawing:

Dimensions: L.,

H.,

W.,

Th.,

Technique:

Condition: worn - fragmentary

Description: from # PZ-81-406 PL

gray ware rim with moulded circular decoration

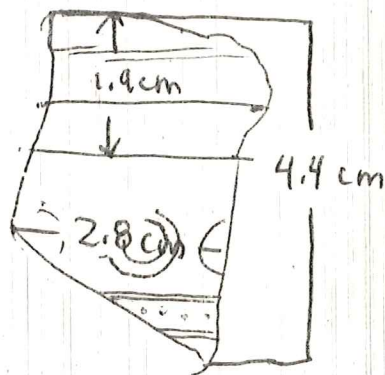

approx. thickness
0.4 cm

TEXAS

Date: 12 June 1981

No. PZ-81-408T

Object: Circular loom wt.

Material: Terracotta

Square: J¹-1 Bat. 15B
new deposit -
Cer

Photograph:

Level:

Drawing:

Dimensions: L.,

H.,

W.,

Th.,

Technique:

Condition: good but chipped

Description: From # PZ-81-406 PL

One circular loom wt. of Munsell 5YR
7/4 pink - wt. has one centrally placed
hole at the top the back of the wt.
is severely chipped.

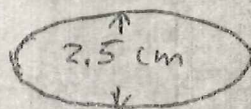
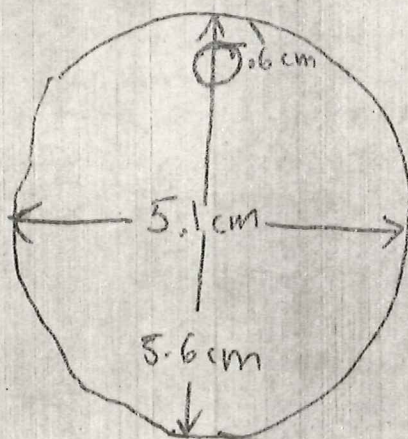

TEXAS

Date: 12-VI-81

No. PZ-81-410T

Object: loom wt - Stamped

Material: TerraCotta

Square: J-1 Batt 15B

Photograph:

West-side

Level: gray Brown - Dk gray

Drawing:

Dimensions: L.,

H.,

W.,

Th.,

Technique:

Condition: very good but slightly encrusted.

Description: From PZ-81-409 PL

1 circular loom wt. with 2 holes. Center of loom wt. is stamped with star-like design.

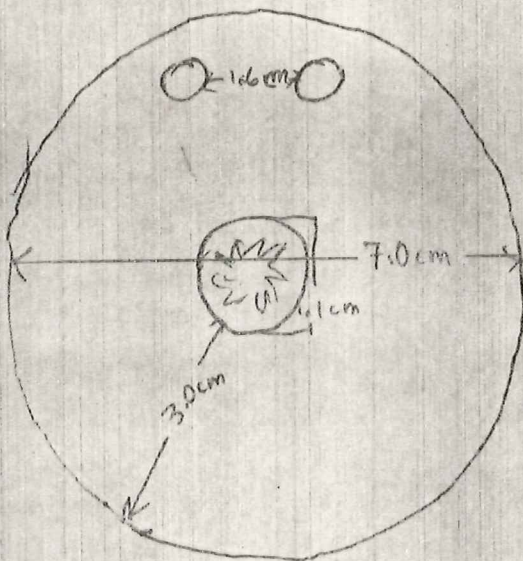

approx. thickness
1.8 cm

Munsell 5YR
7/6 reddish yellow

TEXAS

Date: 12-VI-81

No. PZ-81-411 M

Object: lead repair clamp

Material: lead

Square: J^L-1 Butt 15 B
West-Side
Sr - Br - Dk Gray
Level:

Photograph:

Drawing:

Dimensions: L.,

H.,

W.,

Th.,

Technique:

Condition: corroded

Description:

from # PZ-81-409 PL

1 lead clamp probably used for repair

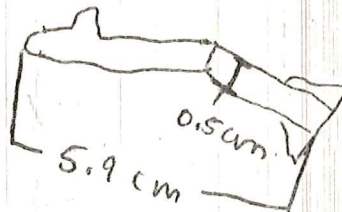

TEXAS

Date: 12-VI-81

No. PZ-81-416P

Object: 1/2 of gray ware spout

Material: Pottery

Square: J-L Between
Batt 13B + 16D
Level: inclusive

Photograph:

Drawing:

Dimensions: L.,

H.,

W.,

Th.,

Technique:

Condition: worn + broken

Description: from # PZ-81-415 P2

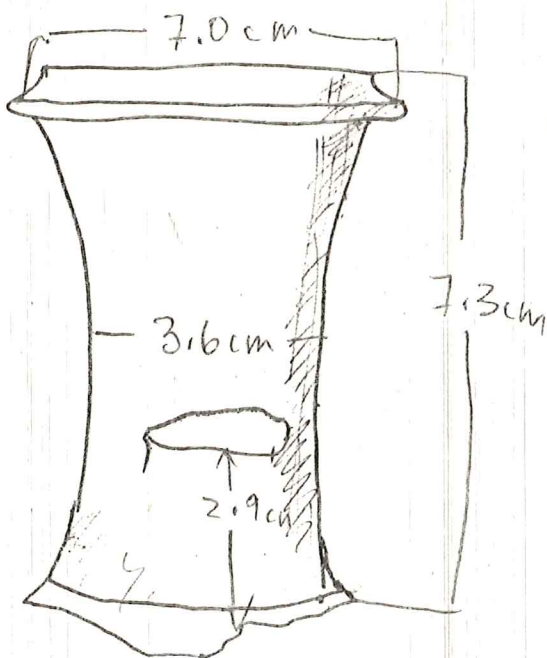

1/2 of gray ware spout - 3 straining holes remain
at bottom - base of handle is still attached
to preserved side.

TEXAS

Date: 12-VI-413 PL

No. PZ-81-417 P

Object: deep gray ware bowl (profile)

Material: Pottery

Square: J1-1 Bath. 15B
w. side / w. deposit
DK Gray
Level:

Photograph:

Drawing:

Dimensions: L.,

H.,

W.,

Th.,

Technique:

Condition: very worn - fragmentary

Description: From PZ-81-413 PL

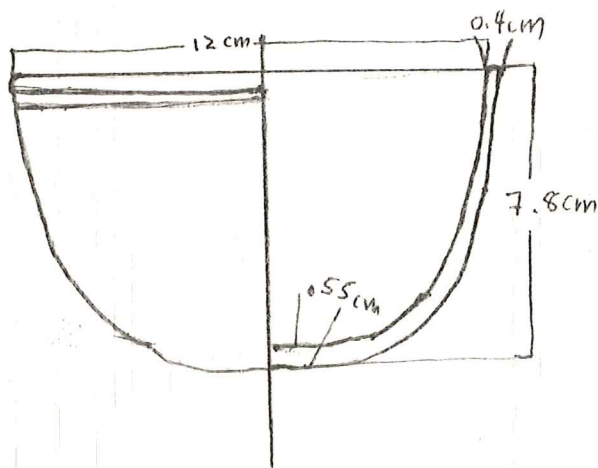

gray ware bowl with rounded base and two incised lines at upper rim.

TEXAS

Date: 12-VI-81

No. Pz-81-418P A+B

Object: 2 Gray ware moulded rims

Material: Pottery

Square: J1-1 Between
tuff 13B + 16D inc.

Photograph:

Level:

Drawing:

Dimensions: L.,

H.,

W.,

Th.,

Technique:

Condition: good

Description:

from # Pz-81-415 PL

2 Gray ware moulded rim fragments with ivy
leaf design

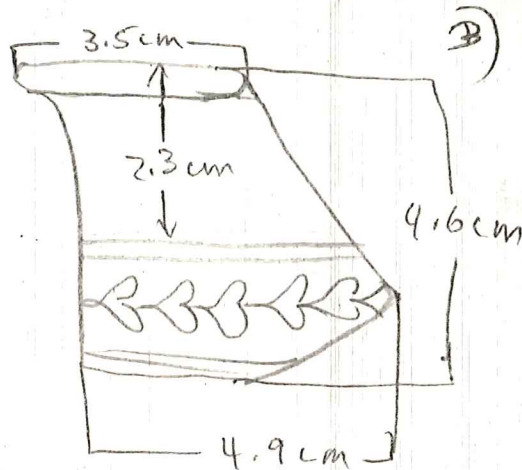
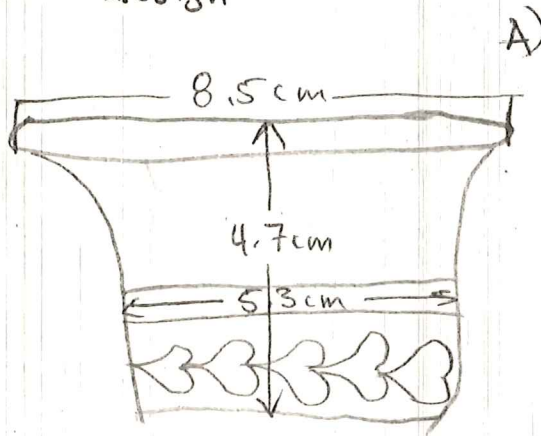

TEXAS

Date: JUNE 27, 1981

No. P2-81-425B

Object: Lots of Bones Material: Bone

Square: N.W. Trench
Batt 5 Bone + ceramic
Level: cone.

Photograph:

Drawing:

Dimensions: L., H., W., Th.,

Technique:

Condition:

Description:

TEXAS

Date: 1 July 1981

No. PZ-81-428T

Object: Terracotta loom wt

Material: Terracotta

Square: Backhoe Trench

Photograph:

Level:

Drawing:

Dimensions: L.,

H.,

W.,

Th.,

Technique:

Condition: Good -

Description:

Terracotta loom - Centers of both front and back seem to have been etched -

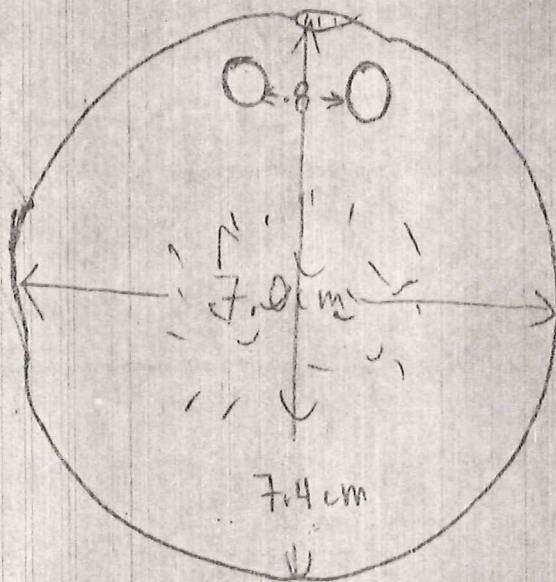

approx thickness 2.0cm

Munsell 5YR
7/3 pink

TEXAS

Date: 2 July 1981

No. PZ-81-429 B5

Object: 2 shells

Material: shell (aragonite)

Square: Well Trench

Photograph:

M'-6 B, 2

Level: Olive grey

Drawing:

Dimensions: L.,

H.,

W.,

Th.,

Technique:

Condition: fair.

Description:

pleistocene
2 shells embedded in original soil -
Munsell 5Y 8/1 white

TEXAS

Date: 15-VI-81

No. PZ-81444P

Object: moulded gray ware bowl

Material: Pottery

Square: J-1 Batt 16)
Ceramic Concen-
Level: tration

Photograph:

Drawing:

Dimensions: L.,

H.,

W.,

Th.,

Technique:

Condition: fragmentary but good

Description: (plus 1 frag (body sherd) from PZ-81-4/9PL)

Moulded gray ware bowl in many pieces -
at bottom, less are formed of two wheel-like
discs.

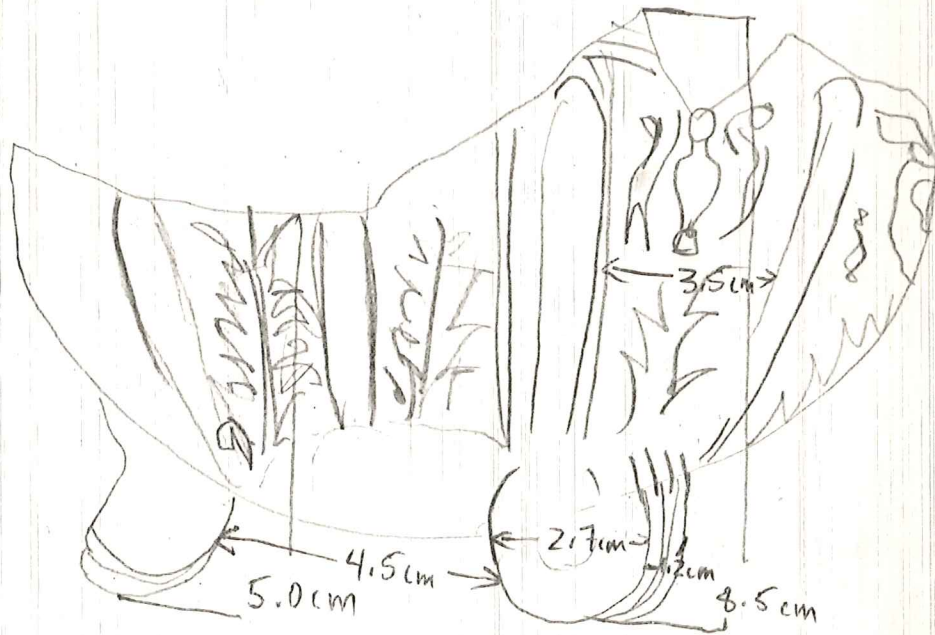

approx. thickness

The 7 chips seem to belong to bowl 0.4 cm

TEXAS

Date:

No. PZ -81 -445

Object:

Material:

Square:

Photograph:

Level:

Drawing:

Dimensions: L.,

H.,

W.,

Th.,

Technique:

Condition:

Description:

TEXAS

Date: July 1, 1981

No. P2-81-450B

Object: Bones

Material: Bone

Square: NW Trench
Batt. 7 of Ceramic
Dep. + Southern Bone
Level: Concentration.

Photograph:

Drawing:

Dimensions: L.,

H.,

W.,

Th.,

Technique:

Condition:

Description:

TEXAS

Date: 16 June 1981

No. PZ-81-452T

Object: Pan Tile Frag.

Material: Terracotta

Square: A. W. French
Tile, Lga. Rock +
undis

Photograph:

Level:

Drawing:

Dimensions: (L., max. preserved) H.,

W., (max. preserved) Th., at raised

Technique: 15.2cm.

13.0cm. edge: 6.0cm

Condition:

Fragment - encrusted + worn

inside: 2.5cm

Description:

Munsell: Core 5YR 7/4 (pink)

Outside 10YR 8/4 (very pale
brown)

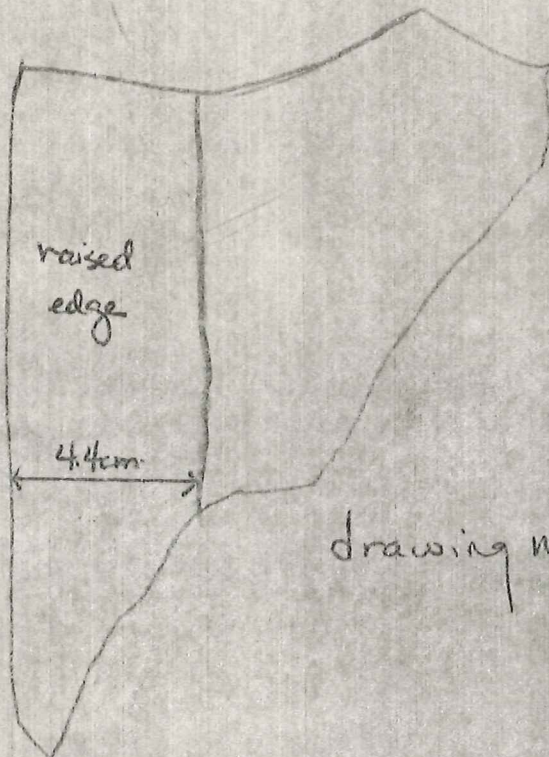

drawing not to scale

TEXAS

Date: 17-VI-81

No. PZ-81-453T

Object: pyramidal loom wt.

Material: Terracotta

Square: NW Trench
Batt. 2 in front of
tile fall

Photograph:

Level:

Drawing:

Dimensions: L.,

H.,

W.,

Th.,

Technique:

Condition: good but encrusted

Description:

From # PZ - 81 - 438 PL

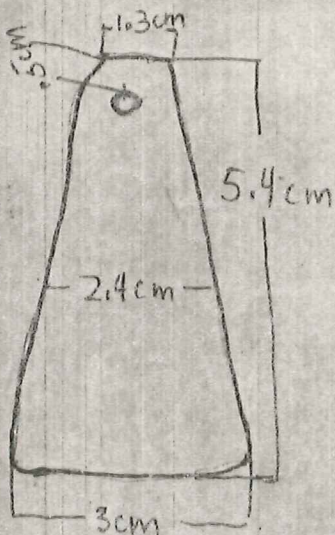

Small slightly chipped
pyramidal loom wt. of
Munsell 5YR 7/3 pink.

TEXAS

Date: 15 June 1981

No. PE-81-454 P

Object: Gray Ware Strainer neck

Material: Pottery / Ceramic

Square: J-1 Batt. 16D

Photograph:

Ceramic Concentration

Level: *

Drawing:

Dimensions: L.,

H., 6 cms

W., 7.1 cms at rim,

Th., 0.3 cms

Technique: gray ware.

Condition: mounted, and about one-third of the rim is missing.

Description:

(from PE-81-423 PL).

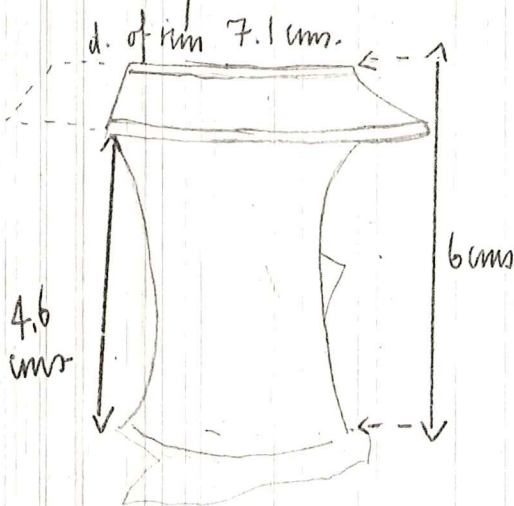

Rim and neck of gray-ware strainer. A large fragment of the rim is missing, and only very small parts of the shoulders survive. The rim is wide and down-turned. There are five holes in the wall between the neck and the shoulders, two of which have run together. Only the base of the handle remains.

TEXAS

Date: 24-June 1981

No. PZ-81-4555

Object: S.S. 3 (Soil Sample)

Material: ~~§~~ Varied

Square: NW Trench
Ceramic Dep.

Photograph:

Level:

Drawing:

Dimensions: L.,

H.,

W.,

Th.,

Technique:

Condition:

Description:

TEXAS

Date: 24 June 1981

No. PZ-81-462B

Object: Bones

Material: Bone

Square: NW Trench
Level 2
Ceramic Dep.
Level:

Photograph:

Drawing:

Dimensions: L.,

H.,

W.,

Th.,

Technique:

Condition:

Description:

TEXAS

Date: 19 June 1981

No. PZ-81-472M

Object: Metal Slag.

Material: Slag

Square: NW Trench

Photograph:

Batt. 5

Level: E. to Ctr.
Yellow SA

Drawing:

Dimensions: L.,

H.,

W.,

Th.,

Technique:

Condition:

Description:

TEXAS

Date: 19 June 1981

No. PE-81-473B

Object: Bones

Material: Bone

Square: NW Trench
Batt. 5 E. to ctr.

Photograph:

Level: Yellow SA

Drawing:

Dimensions: L.,

H.,

W.,

Th.,

Technique:

Condition:

Description:

TEXAS

Date:

19 June 1981

No. PZ-81-474B

Object:

Bones

Material: Bone

Square:

NW Trench
Batt. 5 Red-Brown

Photograph:

Level:

SA E. to Ctr.

Drawing:

Dimensions: L.,

H.,

W.,

Th.,

Technique:

Condition:

Description:

TEXAS

Date: 19-VI-81

No. PZ-81-475P

Object: fragment of shallow mortarium with ^{SPQR} Material: Pottery

Square: NW Trench
Batt. 5
Mottled brown + red
Level: center trench

Photograph:

Drawing:

Dimensions: L., H., W., Th.,

Technique:

Condition: chipped - fragmentary but good -

Description: From PZ-81-459 PL

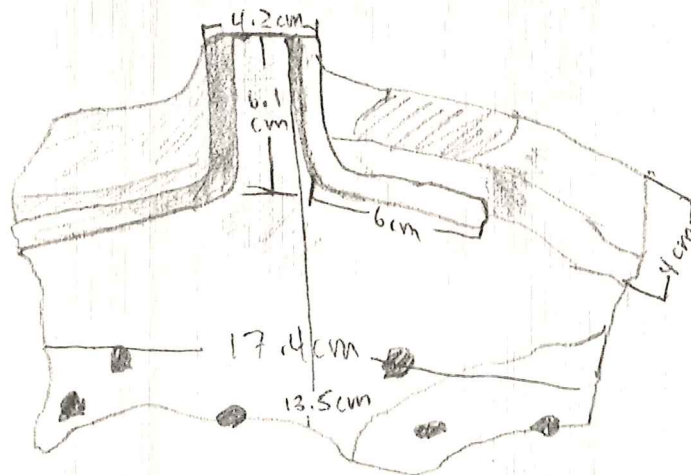

Approx. thick.
1.5 cm

Munsell 5YR 7/4 pink

fragment from large - shallow circular mortarium with
SPQR. Chips of lava or iron have been
inserted into the hollow of the bowl.

TEXAS

Date: 16 June 1981

No. PZ-81-476T

Object: [redacted] Cylindrical Loom Wt. Material: Terracotta

Square: NW Trench

Photograph:

Batt. 2

Level: Cleaning

Drawing:

Dimensions: L.,

H., 4.9 cms.

W.,

Th.,

Technique:

Condition: slightly chipped and considerably encrusted.

Description:

(from PZ-81-431 PL)

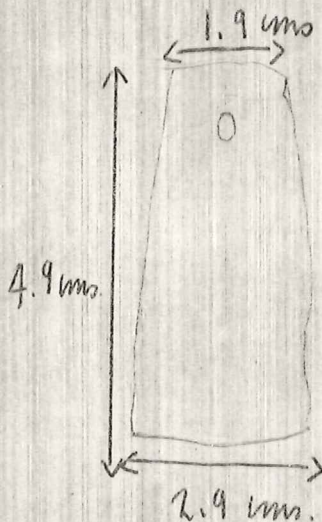

Colour of clay:
Munsell 7.5 YR 8/4
pink
with darker red spots.

The weight is cylindrical in shape, tapering from top to bottom. Holes pierced through near top. The sides are smooth.

TEXAS

Date: 15 June 1981

No. PE-81-477B

Object: Boxes

Material: Bone

Square: J1-1 Batt. 15B

Photograph:

Tile + coarse

Level: Concentration

Drawing:

Dimensions: L.,

H.,

W.,

Th.,

Technique:

Condition:

Description: (from PE-81-419 PL)

TEXAS

Date: 22 June 1981

No. PZ-81-478M

Object: 2 pieces of metal

Material: Iron

Square: NW Trench

Photograph:

Batt. 7 Brown

Level: Sand w/
gravel

Drawing:

Dimensions: L.,

H.,

W.,

Th.,

Technique:

Condition: Very corroded

Description:

(from PZ-81-466 PL)

TEXAS

Date: 22 June 1981

No. PZ-81-479M

Object: Iron frag. of nail?

Material: Iron

Square: NW Trench

Photograph:

Batt. 6 Red

Level:

Brown

Drawing:

Dimensions: L., 5.8cm. H.,

W.,

Th.,

Technique: (metal preserved).

Condition: very corroded - Poor

Description:

Diam. at ends: 1.5cm.
1.3cm.

TEXAS

Date:

22 June 1981

No.

PZ-81-480M

Object:

2 chunks slag, 1 elongated piece

of iron

Material: Metal

Square: NW Trench

Batt. 7 Brown

Sand w/ gravel

Level:

Photograph:

Drawing:

Dimensions: L.,

H.,

W.,

Th.,

Technique:

Condition:

Unaltered.

Description:

(from PZ-81-468PH).

TEXAS

Date: 22 June 1981

No. PZ-81-481B

Object: Boxes

Material: Boxe

Square: N W Trench
Batt. 6 W. end
Reg - Brown to
Level: Olive Yellow

Photograph:

Drawing:

Dimensions: L.,

H.,

W.,

Th.,

Technique:

Condition:

Description:

TEXAS

Date: 19 June 1981

No. PZ-81-482T

Object: Round loom wt.

Material: Terracotta

Square: NW Trench
Batt. 5 mottled
burnt red Ctn
Level: Trench

Photograph:

Drawing:

Dimensions: L.,

H.,

W.,

Th. at base, 1.9
mm

Technique:

Condition: chipped and eroded

Description:

(from PZ-81-459PL)

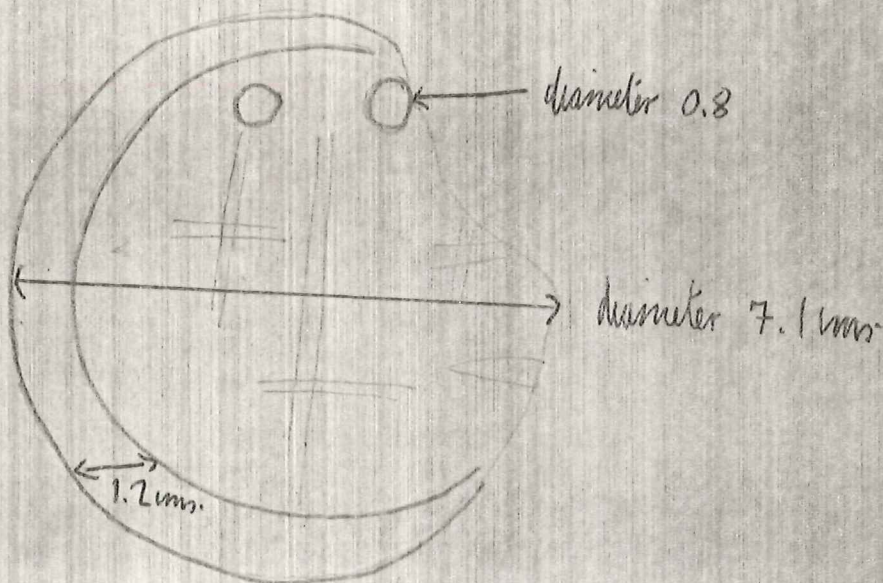

The loom weight has a raised border and, on
on both sides.
one side, a pattern of lines crossing at 90°
angles.

Clay color: Munsell 2.5YR 6/8 light red on decorated
side
" 7.5YR 7/4 pink on plain side.

TEXAS

Date: 19 June 1981

No. PZ-81-483P

Object: 2 chunks ceramic slag

Material: Ceramic

Square: NW Trench
Batt. 5 E. toctr.

Photograph:

Level: Yellow SA

Drawing:

Dimensions: L.,

H.,

W.,

Th.,

Technique:

Condition:

Description:

TEXAS

Date: 15 June 1981

No. PZ-81-484B

Object: Bones

Material: Bone

Square: J1-1 Ball.

Photograph:

Level: 17D. to Virgin

Drawing:

Dimensions: L.,

H.,

W.,

Th.,

Technique:

Condition:

Description: (from PZ-81-427 PL)

TEXAS

Date:

No. PE-81-486

Object:

Material:

Square:

Photograph:

Level:

Drawing:

Dimensions: L.,

H.,

W.,

Th.,

Technique:

Condition:

Description:

TEXAS

Date:

No. PZ-81-496-OPEN

Object:

Material:

Square:

Photograph:

Level:

Drawing:

Dimensions: L.,

H.,

W.,

Th.,

Technique:

Condition:

Description:

[Handwritten scribbles]

TEXAS

Date: 11th June 81

No. PZ-81-497P

Object: large coarse-wave amphora

Material: pottery

Square: W. ext. of NS trench
J'-1 ramp section B, S end,
yellow olive br- dk gray-
Level: + see below.

Photograph:

Drawing:

Dimensions: L.,

H.,

W.,

Th.,

Technique:

Condition: fragmentary.

Description:

(from 3 PL's: mostly from PZ-81-267 - see above,
also from PZ-81-269, J'-1 ramp section B,
N end, dark gray-brown
and from PZ-81-271, J'-1 ramp section B,
N end, dark gray brown).

Most of the neck and the handles, and the shoulders, have
been restored in one piece. Two fragments
from the body survive separately.

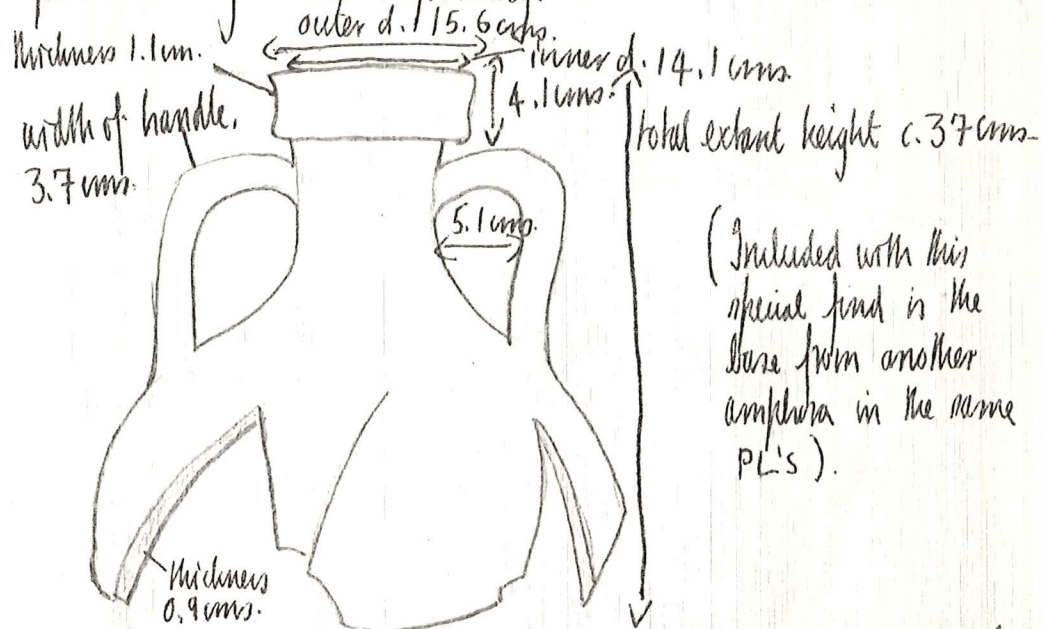

This amphora has a concave rim and tubular handles, rising from the shoulders, which curve gradually into the bulbous body.

TEXAS

Date: 12 June 1981

No. PE-81-498P

Object: very large coarse ware amphora ^{rim} ^{handle} _{body} Material: Ceramic

Square: J 1 - 1 Batt.
14B Ceramic Dep.

Photograph:

Level:

Drawing:

Dimensions: L.,

H.,

W.,

Th.,

Technique:

Condition: good but fragmentary

Description:

(from PE-81-359PK)

One very tall necked amphora of a porous buff fabric. On the pinkish interior there are red inclusions in the fabric which John Hayes says may suggest that it came from Apulia. Since we have had numerous fragments of this fabric, vessels may have been of local manufacture.

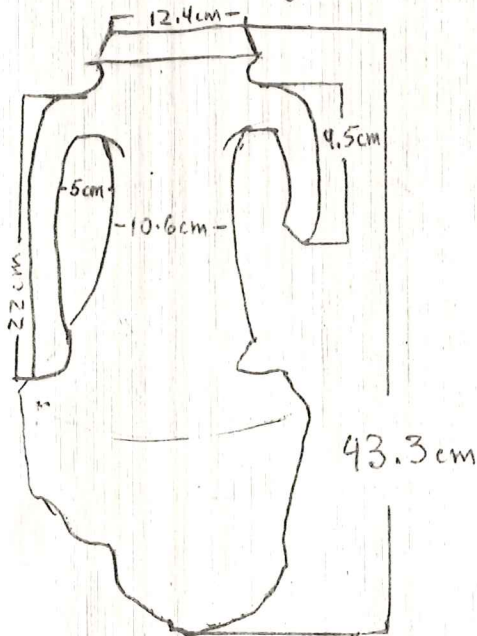

approx. Thick. 1.5 cm

munsell - exterior 10 YR 8/1 white

interior 7.5 YR 8/2

TEXAS

Date: 12 June 1981

No. PE-81-499P

Object: Badly misfired, deformed amphora ^{rim, neck, handles} Material: Ceramic

Square: J¹-1 Batt. 148
Ceramic Deposit

Photograph:

Level:

Drawing:

Dimensions: L.,

H.,

W.,

Th.,

Technique:

Condition: Good but misfired.

Description: (from PE-81-359 PL) } 1 extra body sherd.
(from PE-81-343 PL)
(from PE-81-414 PL)

1 misfired amphora neck with
bulging neck rim and handles.

Munsell =

exterior ranges from
5Y 8/4 pale yellow
to 5Y 6/2 light olive gray
interior is of

2.5 YR N3 - very
dark gray.

The ruptured parts are
also of this color.

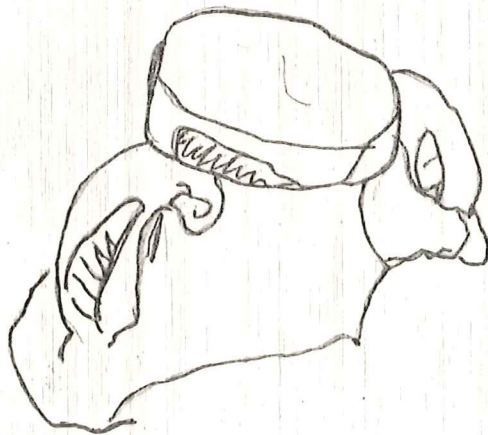

diameter of neck

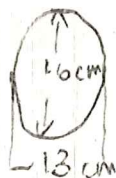

max height of ^{preserved.} object 14.5cm.

max. thick. of neck 3.5cm

min. thick of neck 2.4cm

max thick. of body 2.8cm

min. thick. of body .9cm

thickness of handles

range from 2.4cm to
3.5cm.

Date: June 26, 1981

No. P2-81-518B

Object: Bone

Material: Bone

Square: NW Trench
Ceramic Depo.
Batt. 5 Level 4
Level:

Photograph:

Drawing:

Dimensions: L.,

H.,

W.,

Th.,

Technique:

Condition:

Description:

TEXAS

Date: 12 July 1981

No. PZ-81-519P

Object: Coarse ware amph. neck + rim.

Material: Ceramic

Square: J¹-1 Batts
14B + 15B

Photograph:

Level:

Drawing:

Dimensions: L.,

H.,

W.,

Th.,

Technique:

Condition: fragmentary encrusted

Description:

Munsell 7.5YR 7/6 (reddish yellow)
(from PZ-81-382 PL + PZ-81-412 PL)

One unexceptional coarse ware amphora neck
with 2 handle shvs.

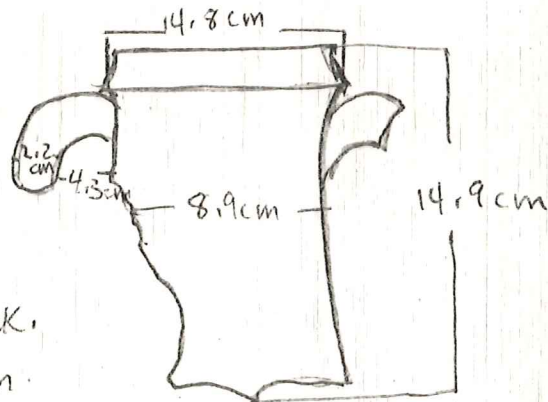

approx. thick.
0.7 cm.

TEXAS

Date: 12 June 1981

No. PZ-81-520P

Object: Rim, neck handle of narrow neck jug. Material: Ceramic

Square: T 1 - 1 Between
13 at 13 B + 160
Level: inclusive

Photograph:

Drawing:

Dimensions: L.,

H.,

W.,

Th.,

Technique:

Condition:

Description: (from PZ-81-339PK, PZ-81-382PK, and PZ-81-415PK)

Munsell: 5YR 7/6 reddish yellow

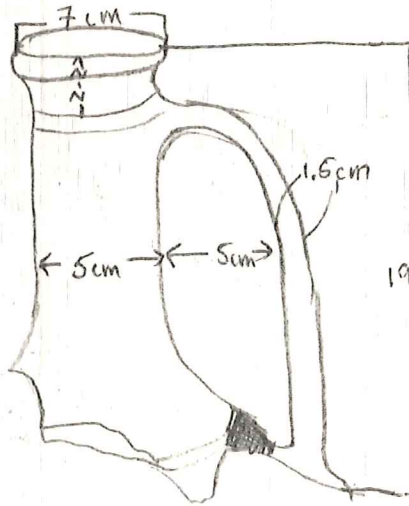

restoration.

Neck and handle of a narrow necked jug with offset rim. At the top of neck, two incised lines circle the neck where the handle joins.

For similar neck with body see PZ-81-355 P

TEXAS

Date: 27 June 1981

No. PZ-81 521B

Object: Boxes

Material: Box

Square: NW trench
Batt. 6

Photograph:

Level: Level 4

Drawing:

Dimensions: L.,

H.,

W.,

Th.,

Technique:

Condition:

Description:

TEXAS

Date: 27-VI-81

No. P2-81-521B

Object: Boxes

Material: Bone

Square: NW Trench
Ceramic Dip

Photograph:

Level: BATH Level 4

Drawing:

Dimensions: L.,

H.,

W.,

Th.,

Technique:

Condition:

Description:

TEXAS

Date: 25 July 1981

No. PZ-81-522P

Object: Gray Ware Plate

Material: Ceramic

Square: NW Trench

Photograph:

Ceramic Dep.
level 3

Drawing:

Dimensions: L.,

H., ~7.2 cm

W.,

Th., 0.4 cm (rim)

Technique:

Diameter ~32.0 cm

to

Diameter of foot 7.3 cm

0.6 cm (body)

Height of foot 1.5 cm

Condition: $\frac{2}{3}$ of the vessel is preserved; chipped and encrusted

Description: Large gray ware plate w/ tall ring foot and a hawk's beak rim. The lower portion of the plate is round in profile, as a bowl; the upper portion up to the rim is horizontal. The base is divided into two equal sections by a sharp ridge. Glaze is medium gray w/ mottled olive and some light gray. The exterior $\frac{1}{3}$ (lower) has a dribble pattern. Clay is fine and compact.

TEXAS

Date: 25 June 1981

No. P2-81-524P

Object: Jug mouth, handles, and portion of shoulder Material: Ceramic

Square: NW Trench
Level 1, Batt. 3

Photograph:

Level:

Drawing:

Dimensions: L., H., 7.8 cm W., Th., 0.3 cm (rim)

Technique: Diameter - interior 7.1 cm exterior 11.25 cm
to 0.35 (bottom of preserved body)

Condition: Fragmentary, 1/3 is preserved. Somewhat encrusted on both the interior and exterior.

Description: Mouth, ribbon handles (2) and shoulder portion of a jug. The vessel has a horizontal rim and necking bands which divide the neck from the body of the vessel. See P2-81-573P for a similar jug. The glaze on the exterior is a medium black. The majority of it has flaked off as has the olive gray glaze of the interior.

TEXAS

Date: 25 June 1981

No. PZ-81-525M

Object: Part of Seal ring

Material: BRONZE?

Square: N10 Trench
Ramp Beta
Yellow BR

Photograph:

Level:

Drawing:

Dimensions: L.,

H.,

W.,

Th.,

Technique:

Condition: fragmentary and encrusted.

Description:

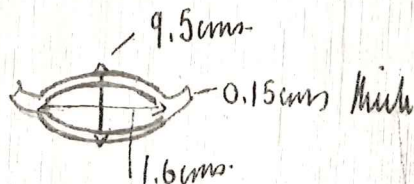

average thickness 0.2cms

The loss of the ring and the starts of the arms only have survived. There are no obvious indications of any provision for the attachment of a seal-stone, though the loss is hollowed out to some extent, ^{inside of a raised rim.} If it originally possessed its own pattern in relief, this is no longer visible.

The ring is fragmentary and fragile, and bluish-green in colour.

TEXAS

Date: 25 June 1981

No. PE-81-528P

Object: large Coarse Ware Amph.

Material: Ceramic

Square: NW Trench
Ceramic Dep

Photograph:

Level: 1 Butt 3

Drawing:

Dimensions: L.,

H., max preserved W.,

Th., of body

Technique: interior-dian, inside of neck base: 10.9cm

34.0cm.

1.0cm.

at min. 1.8cm

Condition: Fragmentary - Neck to shoulders almost complete

Description: Sixteen fragments nine chips.

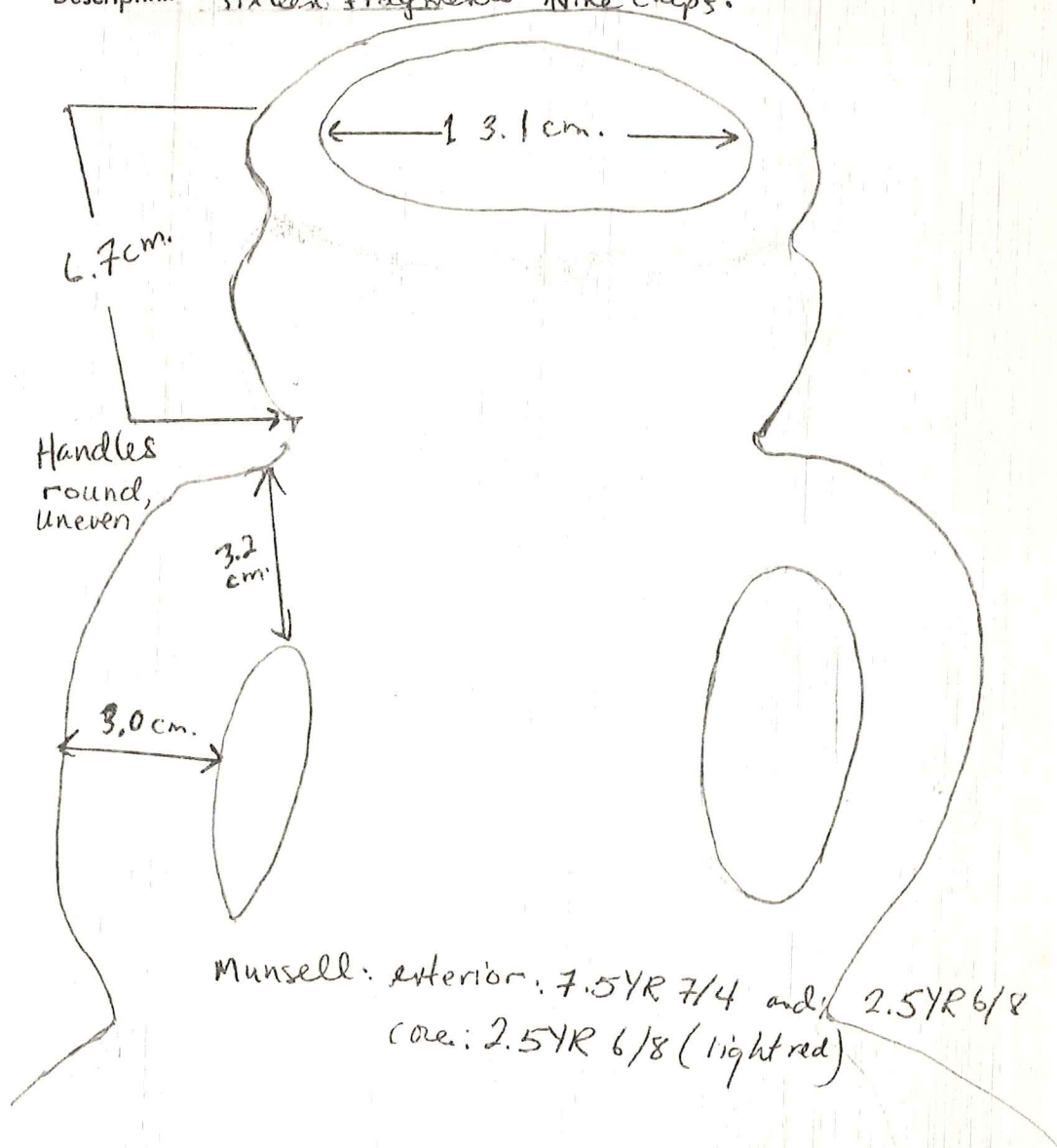

TEXAS

Date: 24-June 1981

No. PZ-81-5298

Object: BONES

Material: Bone

Square: NOT RECENT
BATT. 15
TO DEPOSIT

Photograph:

Level:

Drawing:

Dimensions: L.,

H.,

W.,

Th.,

Technique:

Condition:

Description:

TEXAS

Date: 25 June 1981

No. PZ-81-530P

Object: Gray Ware Plate

Material: Ceramic

Square: N W TRENCH

Photograph:

Bath. 3
Level 1

Level:

Drawing:

Dimensions: L.,

H., 6.8 cm

W.,

Th., 0.4 cm
(rim)

Technique:

Diameter 7.8 cm

to

Condition:

Diameter of foot 7.7 cm

0.9 cm

Height of foot 0.35 cm

(base)

Description:

(from PZ-81-527 PL)
(and PZ-81-623 PL)

Large, slightly sloping gray ware plate w/ a ring foot. The rim, round at the top, is a concave band. The vessel has been misfired so that the interior ranges in color from blue/black to green w/ a black center delineated from the interior by its color and incision lines. The exterior ranges from olive/gray and medium black to a beige where the vessel, if it were a pyramidal banded vase, would be light gray.

TEXAS

Date: 12 July 1981

No. PZ-81-532 P

Object: black stage rim or base

Material: pottery

Square: J^v-1

Photograph:

Box: 15 B

Level: W. Side Gray Br.

Drawing:

Dimensions: L.,

H.,

W.,

Th.,

Technique:

Condition: Fragmentary but good

Description: From # PZ-81-404 PL

1 piece from PZ-81-415 PL

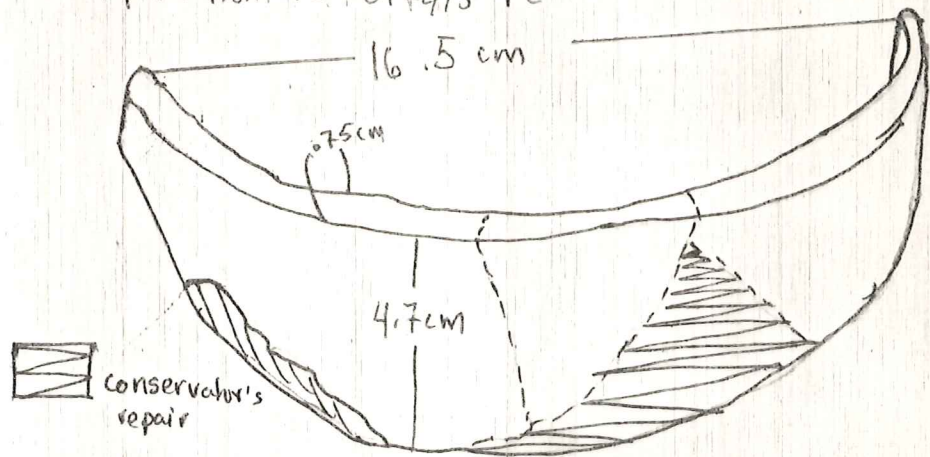

one rim fragment to black-staged vessel.
John Hayes says that it may be rim to a base
of very large vessel.

Munsell 5YR 7/4 pink.

TEXAS

Date: June 24, 1981

No. P2-81-535B

Object: BONES

Material: Bone

Square: NW Trench
Butt. 13
Yellow Br to Ceramic

Photograph:

Level:

Drawing:

Dimensions: L.,

H.,

W.,

Th.,

Technique:

Condition:

Description:

TEXAS

Date: June 23, 1981

No. P2-81-536B

Object: Bones

Material: Bone

Square: N.W. Trench
Dist. 9 west Ramp
Yellow Br/Br
Level:

Photograph:

Drawing:

Dimensions: L.,

H.,

W.,

Th.,

Technique:

Condition:

Description:

TEXAS

Date: June 22 1981

No. P2-81-532B

Object: Bone

Material: Bone

Square: N.W. Trench
Box 7 Br - Sand w/
Gravel

Photograph:

Level:

Drawing:

Dimensions: L.,

H.,

W.,

Th.,

Technique:

Condition:

Description:

TEXAS

Date: June 23 1981

No. P2-81-538B

Object: Bones

Material: Bone

Square: N.W. Trench

Photograph:

BH. 9 west

Level: Yellow Brand Cer
Dep

Drawing:

Dimensions: L.,

H.,

W.,

Th.,

Technique:

Condition:

Description:

TEXAS

Date: 23rd June 81

No. PZ-81-539P.

Object: Fragment of Pitcher - Rim + neck

Material: Ceramic

Square: NW trench
Blot 9, ramp

Photograph:

Level:

Drawing:

Dimensions: L., 24.5 cms

H., 13.2 cms

W.,

Th.,

Technique: wave ware

Max. thickness
10.9 cms.

Condition: heavily eroded.

Description:

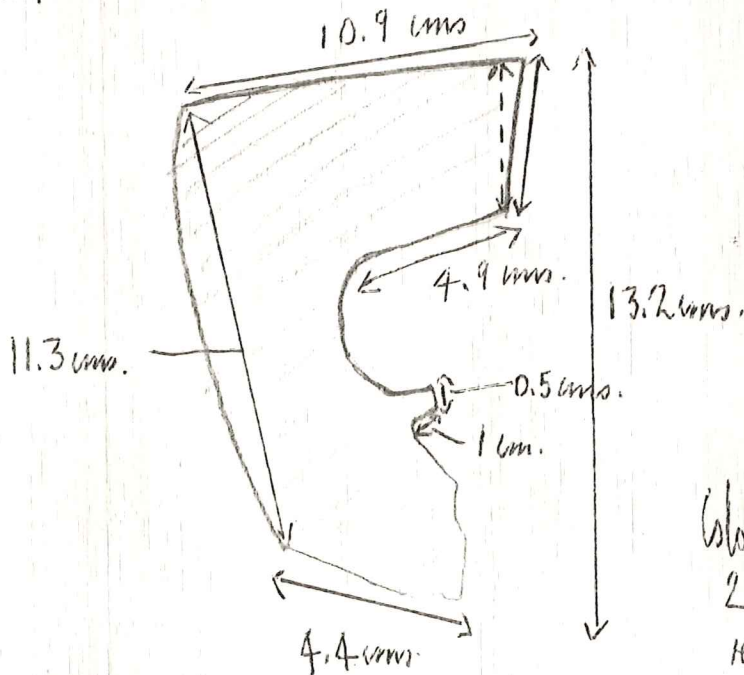

Colour: Munsell
2.5YR 6/6 light
red.

The fragment comes from the rim and upper neck of a large, wave-ware storage vessel, probably a pitcher. The rim is wide and flat, and rises above a concave moulding with a fillet at the bottom. The fabric is very coarse, and pieces of stone are embedded in the construction.

TEXAS

Date: 23rd June 81

No. PZ-81-540 P

Object: fragment of kilnos - Rim

Material: ceramic

Square: NW bench
Batt 9, ramp

Photograph:

Level:

Drawing:

Dimensions: L., 17 mm

H., max. 10 mm

W.,

Th., 7.8 mm

Technique: coarse

Condition: mounted

Description:

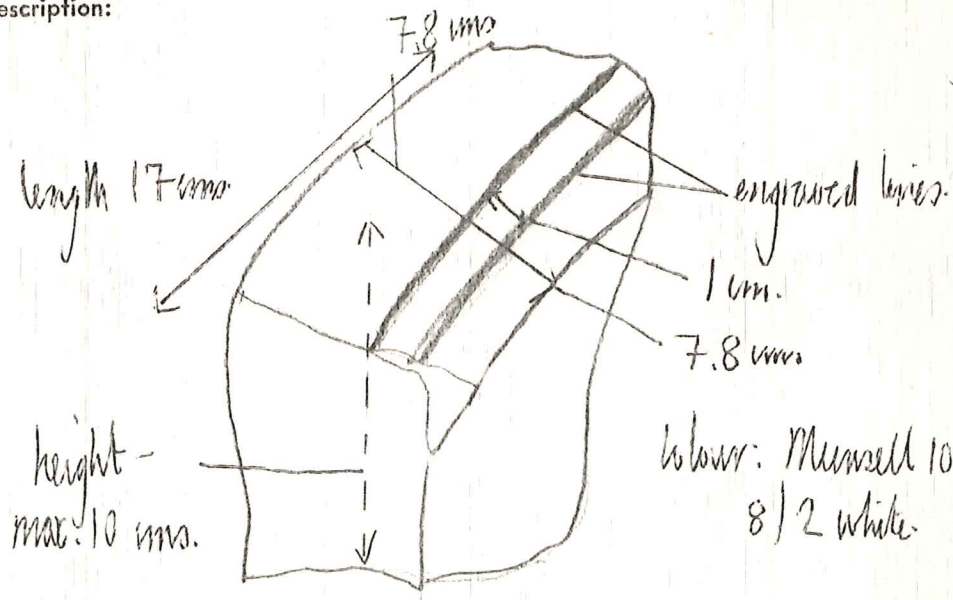

colour: Munsell 10YR
8/2 white.

The fragment comes from the rim of a large coarse-ware storage jar or kilnos. The horizontal surface is decorated with two grooves or engraved lines set 1 cm apart. The inner and outer walls are smooth. The fabric is very coarse.

TEXAS

Date: 12-VI-81

No. PZ-81-541 P

Object: neck handle frag of storage jug Material: Pottery

Square: J-1 Bath. 14 B
West 1/2 gray-brown

Photograph:

Level:

Drawing:

Dimensions: L.,

H.,

W.,

Th.,

Technique:

Condition: worn - fragmentary

Description: From 377 PL one piece from PZ-81-382 PL

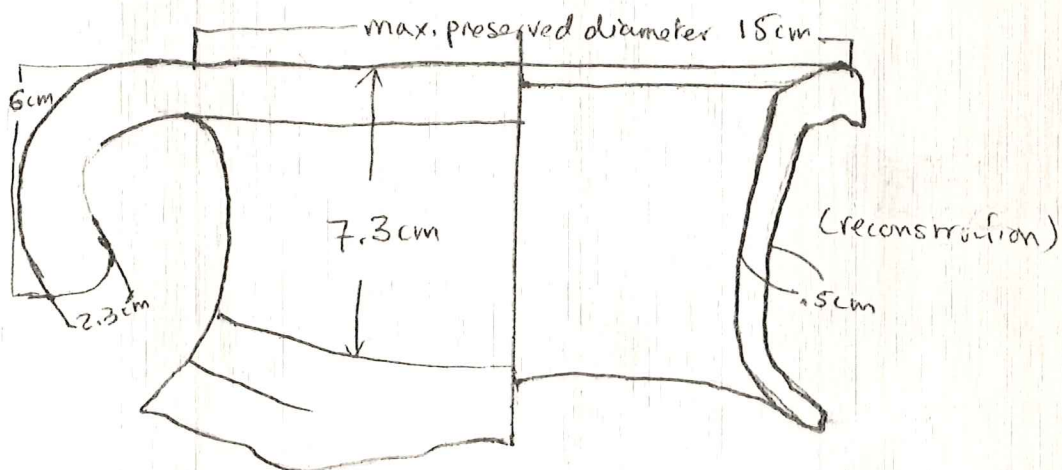

fragment of a squat-necked jug with a very wide neck, fabric is covered with a white wash.

Munsell interior 2.5 YR 6/8 light red
exterior wash - munsell 5 YR 8/3 pale yellow

TEXAS

Date: 24th June 81

No. PZ-81-542B

Object: Bone

Material: Bone

Square: NW bench
ceramic deposit,

Photograph:

Level: level 2

Drawing:

Dimensions: L.,

H.,

W.,

Th.,

Technique:

Condition:

Description: (found with large amphora)

TEXAS

Date: 18th June 81

No. PZ-81-543B

Object: Bone

Material: Bone

Square: NW trench
Batt 3 level 2

Photograph:

Level:

Drawing:

Dimensions: L.,

H.,

W.,

Th.,

Technique:

Condition:

Description: (from PZ-81-442 PL)

TEXAS

Date: 25th June 81

No. PZ-81-544B

Object: Bone

Material: Bone

Square: NW 1/4
Cemini dep.

Photograph:

Level: level 3

Drawing:

Dimensions: L.,

H.,

W.,

Th.,

Technique:

Condition:

Description:

TEXAS

Date: 18th June 81

No. PZ-81-545B

Object: Bones

Material: Bone

Square: NW trench
level 2, Batt 4

Photograph:

Level:

Drawing:

Dimensions: L.,

H.,

W.,

Th.,

Technique:

Condition:

Description:

(from PZ-81-449 PL)

TEXAS

Date: 24th June 81

No. PZ-81-546B

Object: Bone

Material: Bone

Square: N.W. Trench
Batt. 14

Photograph:

Level: yellow Brown to
T. 6.

Drawing:

Dimensions: L.,

H.,

W.,

Th.,

Technique:

Condition:

Description: (from PZ-81-502 PL)

TEXAS

Date: 23rd June 81

No. PZ-81-547B

Object: Bone

Material: Bone

Square: NW trench
Batt 11, ramp

Photograph:

Level: yellow h → 1st.

Drawing:

Dimensions: L.,

H.,

W.,

Th.,

Technique:

Condition:

Description:

TEXAS

Date: 18th June 81

No. PZ-81-548B

Object: Bone

Material: Bone

Square: NW bench
Batt 4, west end

Photograph:

Level:

Drawing:

Dimensions: L.,

H.,

W.,

Th.,

Technique:

Condition:

Description: (from PZ-81-448PL)

TEXAS

Date: 25th June 81

No. PZ-81-549B

Object: Bones

Material: Bone

Square: NW bench
ceramic dep.

Photograph:

Level: Batt 3, level 1

Drawing:

Dimensions: L.,

H.,

W.,

Th.,

Technique:

Condition:

Description:

TEXAS

Date: 25th June 1981

No. PZ-81-550M

Object: 4 pieces of slag

Material: Slag.

Square: NW bench,
ramp.

Photograph:

Level:

Drawing:

Dimensions: L.,

H.,

W.,

Th.,

Technique:

Condition: Poor (unsorted).

Description: (from PZ-81-533 PL)

TEXAS

Date: 19th June 81

No. PZ-81-551M

Object: 2 pieces of slag

Material: Metal

Square: NW bench
yellow sand w/ gravel to
marked, west end.
Level: (Batt. 5)

Photograph:

Drawing:

Dimensions: L.,

H.,

W.,

Th.,

Technique:

Condition:

Description:

(from PZ-81-461PL)

TEXAS

Date: 25th June 81

No. PZ-81-552B

Object: Bones

Material:

Square: NW hunch
ramp

Photograph:

Level:

Drawing:

Dimensions: L.,

H.,

W.,

Th.,

Technique:

Condition:

Description:

(from PZ-81-533PL)

TEXAS

Date: 22nd June 81

No. PZ-81-553M

Object: 1 piece of clay

Material: metal.

Square: NW bench,
balt 8, brown sand

Photograph:

Level: w. gravel

Drawing:

Dimensions: L.,

H.,

W.,

Th.,

Technique:

Condition:

Description:

(from PZ-81-471PL)

TEXAS

Date: 23rd June 81

No. PZ-81-554M

Object: 2 pieces of slag

Material: metal

Square: NW bench.
Butt 9, east 1/2

Photograph:

Level:

Drawing:

Dimensions: L.,

H.,

W.,

Th.,

Technique:

Condition:

Description:

(from PZ-81-490PL)

TEXAS

Date: 16th June 81

No. PZ-81-555M

Object: 1 piece of tag

Material: metal

Square: NW corner,
butt 1,
Level: cleaning.

Photograph:

Drawing:

Dimensions: L.,

H.,

W.,

Th.,

Technique:

Condition:

Description:

(from PZ-81-431PL)

TEXAS

Date: 24th June 81

No. PZ-81-556P

Object: Part of gray-ware jar *Lexythes

Material: ceramic.

Square: NW hench,
halt 14, yellow-brown

Photograph:

Level: to file

Drawing:

Dimensions: L.,

H.,

W.,

Th.,

Technique: gray ware

Condition: fragmentary and slightly eroded.

Description:

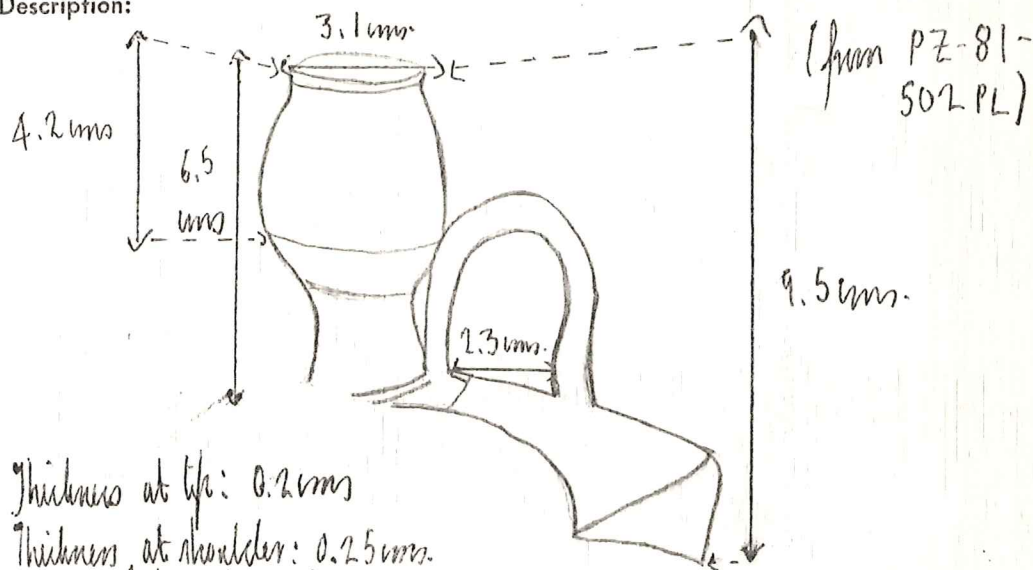

Thickness at lip: 0.2 cm

Thickness at shoulder: 0.25 cm

Width of handle: 1.55 cm

Three fragments from top of gray ware jar, with bulbous lekythos-shaped mouth and almost horizontal shoulder, sharply offset from the body. The vessel has been misfired and is brown and streaky. The strap handle has a central rib and a rib on each side.

TEXAS

Date: 12 June 1981

No. PZ-81-558P

Object: Shallow gray ware bowl

Material: Ceramic

Square: J'-1, Between
Bats 13B & 16D
inclusive

Photograph:

Level:

Drawing:

Dimensions: L.,

H., 7.3 cm

W.,

Th., 0.5 (rim)

Technique:

Diameter \approx 20.0 cm

Diameter of base \approx 5.5 cm

Height of base 0.6 cm

to
1.3 (body
base)

Condition: Encrusted, scratched, stained

Description: From PZ-81-415 PL

Shallow gray ware bowl w/ a plain slightly
offset rim and stippled decoration around the
base of the interior.

TEXAS

Date: 15 June 1981

No. p2-81-659P A, B

Object: Two molded body sherds

Material: Ceramic

Square: J'-J, Dist. 15B
fine and coarse
concentration

Photograph:

Level:

Drawing:

Dimensions: L., A
B

H., A
B

W.,

Th., A
B

Technique:

Condition:

Description: Two molded body sherds, probably of the same vessel.

TEXAS

Date: 15 June 1981

No. PZ-81-560P

Object: Small gray ware Aladdin lamp Material: Ceramic

Square: J¹-1, Bath. 16D
'Ceramic Concentra-
tion'

Photograph:

Level:

Drawing:

Dimensions: L., ~7.8 cm H., ~3.5 cm W., Th.,

Technique: Diameter of oil hole 2.1 cm
Diameter of base 4.25 cm

Condition: Chipped and scratched

Description: Small gray ware Aladdin lamp w/ a typical, but broken spout, and no handle. The lamp has a simple round base. There are finger prints on the body of the vessel and the medium black glaze is flaking off in many parts. The vessel was not well made, as is indicated by the finger prints and the splotchy clay and glaze.

TEXAS

Date: 16 June 1981

No.

PZ-81-561A

Object: Small round gray ware lamp

Material: Ceramic

Square: NW Trench,
Bat. 1 Cleaning
Level:

Photograph:

Drawing:

Dimensions: L.,

H., ~3.8 cm

W.,

Th., 0.35 cm

Technique:

(from spout)

Diameter of
base

rim)

Diameter ~6.8 cm

3.3 cm

to

Condition: fragmentary + weathered

0.8 cm
(body)

Description: From PZ-81-431 PL

Small round gray ware lamp w/ a broken spout and fragmentary oil hole. No handle is preserved. The vessel has weathered and thus the surface is very worn. Traces of blue black glaze remain on the exterior, around the raised foot, around the oil hole, around the rim, and on the spout.

TEXAS

Date: 22 June 1981

No. PZ - 81 - 562A

Object: Kiln support

Material: Ceramic

Square: NW Trench,
Batt. 7, Brown sand
w/ gravel

Photograph:

Level:

Drawing:

Dimensions: L.,

H., 0.8 cm

W.,

Th., 1.0 cm

Technique:

Maximum diameter 4.3 cm

Condition: Fragmentary, approximately 3/5 is preserved; encrusted

Description: from PZ-81-468PL

Round kiln support w/ a flat bottom.

TEXAS

Date: 23 June 1981

No. P2-81-563 P A & B

Object: Two molded gray ware body sherds Material: Ceramic

Square: NW Trench,
Bat. 12, Mottled to
Tile Fall

Photograph:

Level:

Drawing:

Dimensions: L.,

H., A 5.0 cm

W., 6.2 cm

Th., 0.4 cm (top)
to 0.5 cm
(bottom)

Technique:

B 2.3 cm

1.9 cm

0.5 cm

Condition: Weathered and scratched

Description: from P2-81-493 PL

The two sherds do not join and probably belong to different vessels.

A. Molded gray ware sherd w/ upper underconsted register, middle register w/ a band of alternating daisies and concentric circles, a divider of raised bands surrounding dots, and a final floral register, much of which has been obliterated. The piece is probably from a small bowl.

B. Very small gray ware body sherd w/ two registers w/ floral decoration.

TEXAS

Date: 23 June 1981

No. PZ-81-564P

Object: molded gray ware body sherd Material: Ceramic

Square: NW Trench,
Bat. 6, yellow
Brown mixed
Level:

Photograph:

Drawing:

Dimensions: L.,

H., 4.7 cm

W., 3.0 cm

Th., 0.6 cm

Technique:

Condition: Somewhat encrusted and scratched

Description: From PZ-81-488 PL

Molded gray ware sherd w/ three registers. The upper two registers have only floral decoration - leaves, round flowers. The lowest has a figure holding a sceptre in addition to the daisies on the stalks (2).

TEXAS

Date: 24 June 1981

No. P2-81-565P

Object: Molded gray ware body sherd Material: Ceramic

Square: NW Trench
Clearing, Level 1
to Deposit

Photograph:

Level:

Drawing:

Dimensions: L.,

H., 3.2 cm

W., 3.45 cm

Th., 0.4 cm

Technique:

Condition: Lightly encrusted

Description:

From P2-81-514 PL

Molded body sherd w/ decoration comprised of two daisy like flowers surrounding one spikey leaf (pointed) of a three leaved plant. The two other leaves of the plant are touching the bottom edge of the daisies. Fragmentary leaves frame the composition on the lower edges of the sherd.

TEXAS

Date: 24 June 1981

No. P2-81-566P

Object: Molded gray ware rim sherd Material: Ceramic

Square: NW Trench,
Clearing Level 1
Level: to Deposit

Photograph:

Drawing:

Dimensions: L.,

H., 5.6 cm

W., 7.2 cm

Th., 0.6 cm
(rim)

Technique:

Condition:

Description: From P2-81-566P

Fragmentary gray ware rim sherd of a small bowl of the Megarian type. The rim is of the slightly offset concave variety. There are two registers of decoration

① three elongated daisies

② three figural scenes

a. Two people facing one another, one w/ the body turned in the opposite direction

b. A female playing a lyre raised in her left arm.

c. Two figures turned toward one another.

TEXAS

Date: 24 June 1981

No. PZ-81-567P

Object: Misfired molded gray ware (?) sherd Material: Ceramic

Square: NW Trench,
Clearing, Level 1

Photograph:

Level: to deposit

Drawing:

Dimensions: L.,

H., 3.6 cm

W., 6.6 cm

Th., 0.55 cm

Technique:

to

0.65 cm

Condition:

Description: (from PZ-81-515PL)

Misfired gray ware sherd (?) w/ two registers of concentric circles and dashes alternating in a horizontal band. In the third register, 3/4 of a female (?) figure holding a torch in the left hand is preserved.

The glaze on the exterior is a bright reddish-orange. Much of the glaze has flaked off the raised figures. The interior glaze is a burnt orange w/ patches of light orange showing under the black glaze. The clay is semi-course w/ some air holes. Munsell 5YR 6/6 reddish yellow.

TEXAS

Date: 24 June 1981

No. P2-81-568P

Object: Large round gray ware bowl

Material: Ceramic

Square: NW Trench,
Ceramic Deposit

Photograph:

Level: 1

Drawing:

Dimensions: L.,

H., 8.7 cm

W.,

Th., 0.4 cm

Technique:

Diameter 14.3 cm

(rim) 8

Diameter of base 4.75

0.8 cm
(base)

Condition:

a₁₃ preserved; encrusted, scratched and dirt stained

Description: From P2-81-510PL

Large round gray ware bowl w/ two grooves beneath the rim and a simple dish base.

The glaze on both the interior and exterior is a mottled light black/medium gray. The area around the base is especially black.

TEXAS

Date: 24 June 1981

No. PZ-81-570P

Object: Round shallow gray ware bowl Material: Ceramic

Square: NW Trench
Ceramic Deposit
Level 2
Level:

Photograph:

Drawing:

Dimensions: L.,

H., 7.1 cm

W.,

Th., 0.45

(rim) to

Technique:

Diameter ~19.6 cm

Diameter of base 6.0 cm

Height of base 0.6 cm

0.7

(body)

Condition: Somewhat encrusted and chipped

Description: From PZ-81-511 PL.

Shallow round gray ware bowl w/ slightly offset rim and ring base. Portions of the vessel are not the normal color for gray ware and probably reflect a misfiring. The glaze is medium black w/ mottled olive.

TEXAS

Date: 24 June 1981

No. PZ-81-571PA, B, & C

Object: Molded gray ware rim + body of a ^{bowl} Material: Ceramic

A Square: NW Trench
Batt. 15 to Deposit

Photograph:

Level:

Drawing:

Dimensions: L.,	H., A. ~7.9 cm	W., A. ~9.9 cm	Th., A. 0.3 (rim) to 0.6 (body)
Technique:	B. 2.25 cm	B. 4.7 cm	B. 0.35 (top) to 0.5 (bottom)
Condition: Fragmentary, Encrusted	C. 2.5 cm	C. ~5.0 cm	C. 0.5 (top) to 0.6 (bottom)

Description: From PZ-81-506 PL

A. Molded rim and body sherds (join) of a small gray ware bowl which appears to be of the Megarian type. The decorated band consists of spikey plants alternating w/ conch shell flowers and wavy seaweed. Above the spikey plants there are, from left to right, an eros riding on a dolphin, an eel like fish w/ a prong tail and a pointed head, and an undistinguishable mass. A raised band indicative of the base is preserved. The rim is similar to PZ-81-571P. The glaze on both exterior and interior is a shiny dark gray.

B. Provenance - NW Trench, Batt. 15, Yellow Brown
24 June 1981
Encrusted body sherd w/ portions of a conch shell flower, a spikey plant, and three strands of seaweed.

C. Provenance - NW Trench, Ceramic Deposit, Level 3,
Batt. 2
25 June 1981
Encrusted body sherd w/ portions of a spikey plant, a conch shell flower w/ six stems, and another spikey plant.

TEXAS

Date: 26 June 1981

No. PZ-81-572PA + B

Object: Two gray ware Aladdin lamps

Material: Ceramic

Square: NW Trench,
Ceramic Deposit
Level 2, Batt. 3
Level:

Photograph:

Drawing:

Dimensions:	L., Diameter of Height	H., Light hole	W., 1.5 cm	Th., NA
Technique:	Length		A. 4.2 cm	B. 5.0 cm
Condition:	Diameter of oil hole		~9.0 cm	~8.5 cm
	Diameter of base		2.0 cm	~1.75 cm
	Width of spout at end		~4.0 cm	~3.65 cm
			~3.9 cm	NA

Description: Both A and B are typical Aladdin lamps. Neither vessel has a handle preserved, but the spout of A is almost complete and that of B is $3/4$ complete. The glaze of A is blue/black, that of B light black w/ large areas of light gray where the glaze has flaked off. The spouts have a rounded end w/ two triangular projections on either side of the light hole.

TEXAS

Date: 25 June 1981

No. PZ-81-573P

Object: Squat gray ware jug

Material: Ceramic

Square: NW Trench,
Ceramic Deposit
Level 1, Btt 3

Photograph:

Level:

Drawing:

Dimensions: L.,

H., 15.5 cm

W.,

Th., 0.5 cm (rim)

Circumference (at greatest point) ~46.5 cm

Technique: Diameter of mouth - inside vessel 6.5 cm

to
0.7 cm (base)

inside rim 9.45 cm

Condition: Diameter of foot 9.2 cm

slightly encrusted and weathered. Approximately $\frac{1}{4}$ of the vessel is preserved

Description: Small squat gray ware jug w/ two ribbon handles, $\frac{3}{4}$ of one is preserved, and a short ring base. Both the interior and the exterior have raised lines remaining from the turning on the wheel.

The exterior glaze, most of which has flaked off, ranges from a bluish black to an olive gray. The interior is unglazed except for the upper portion of the neck, which is an olive gray.

TEXAS

Date: 22nd June 81

No. PZ-81-574T

Object: Pyramidal horn weight

Material: terracotta

Square: NW bench
Batt 7 brown sand w.

Photograph:

Level: gravel

Drawing:

Dimensions: L.,

H.,

W.,

Th.,

Technique:

Condition: broken at top, encrusted and mis-fired

Description:

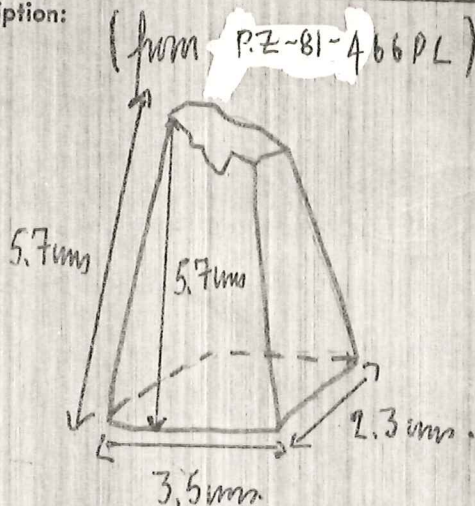

Colour: Munsell 10R
6/2 pale red.

The horn weight is broken at the top across the perforated hole. It is mis-fired and has a bulbous appearance at the base on one side.

TEXAS

Date: 22nd June 81

No. PZ-81-575T

Object: circular brown weight

Material: terracotta

Square: NW corner,
butt 7, brown sand w/
Level: gravel

Photograph:

Drawing:

Dimensions: L.,

H.,

W.,

Th. 1.8 mm

Technique:

Condition: good

Description:

(from PZ-81-466PL)

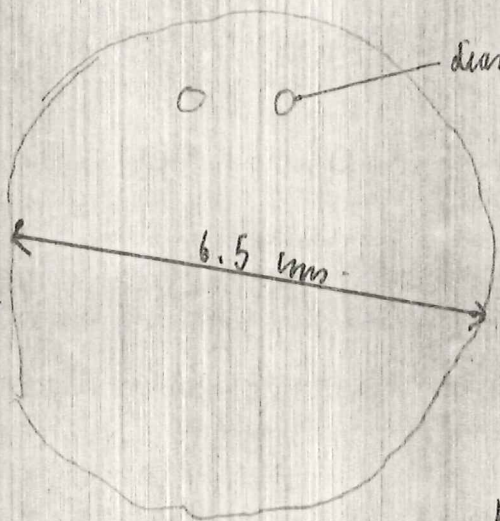

diameter 0.4 mm.

average thickness
1.8 mm

Colour:

Munsell 5YR 7/4
pink

TEXAS

Date: 22nd June 81

No. PZ-81-576T

Object: wintar loom weight

Material: terra-cotta

Square: NW corner,
lattice, brown wood

Photograph:

Level: W. ground.

Drawing:

Dimensions: L.,

H.,

W.,

Th., 2.2 mm

Technique:

Condition: good, slightly chipped.

Description:

(from PZ-81-466 PL)

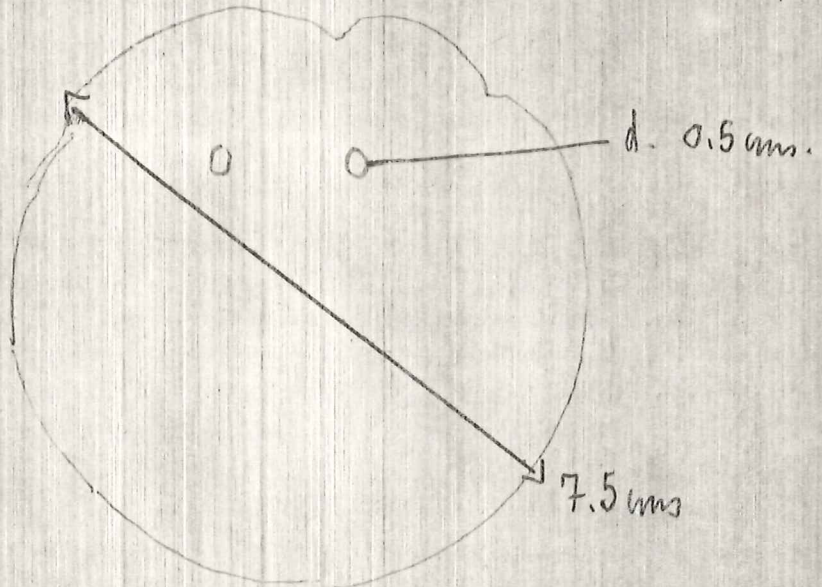

Colour: Munsell 5 YR 7/3 pink

TEXAS

Date: 22nd June 81

No. PZ-81-577T

Object: circular loom weight

Material: terra cotta

Square: NW bench,
Latt 7, brown sand

Photograph:

Level: W1 gravel.

Drawing:

Dimensions: L.,

H.,

W.,

Th. 2 cms.

Technique:

Condition: good.

Description:

(from PZ-81-466 PL)

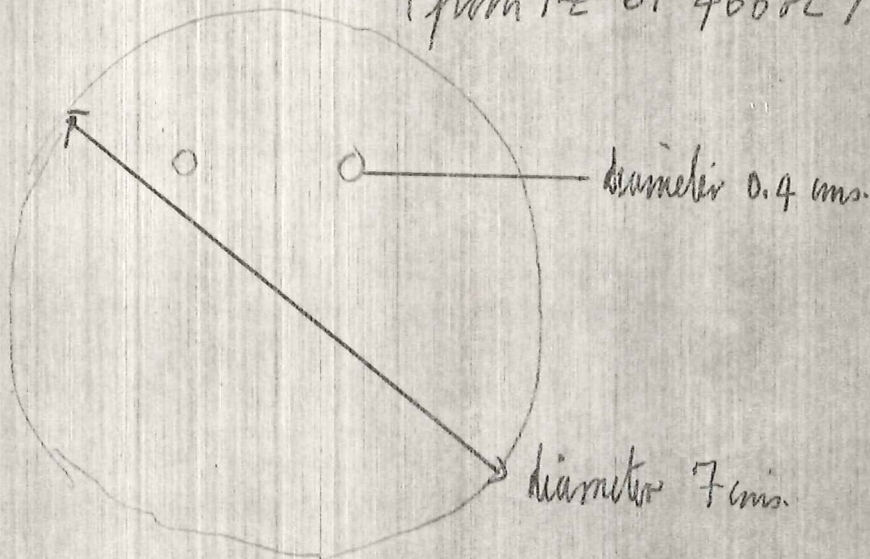

Colour: Munsell 5YR 7/3 pink.

TEXAS

Date: 22nd June 81

No. PZ-81-578T

Object: triconical loom weight

Material: terracotta

Square: NW 1/4 sec. 7,
Twp 7, from sand

Photograph:

Level: w. gravel

Drawing:

Dimensions: L.,

H.,

W.,

Th., max. 3mm
min 0.3mm.

Technique:

Condition: chipped and encrusted

Description:

(from PZ-81-466PL)



profile ↑

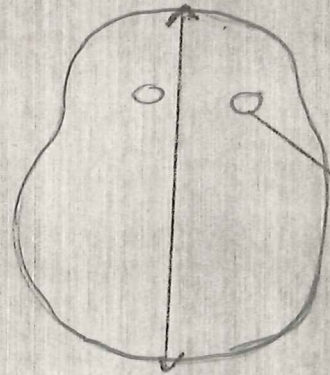

diameter
0.45mm

diameter 7.6mm.

Colour: Munsell 10YR, 7/4
very pale brown

TEXAS

Date:

25 June 1981

No. PZ-81-579B

Object:

Boxes

Material: Bone

Square: NW Trench

Photograph:

Ceramic Dep.

Level: Batt. 3 Level
2

Drawing:

Dimensions: L.,

H.,

W.,

Th.,

Technique:

Condition:

Description:

TEXAS

Date:

19 June 1981

No.

PZ-81-580B

Object:

Bones

Material:

Bone

Square:

NW Trench

Photograph:

Batt. 4 W. end

Level:

For SA W. ground
yellow mottled

Drawing:

Dimensions: L.,

H.,

W.,

Th.,

Technique:

Condition:

Description:

TEXAS

Date: 24 June 1981

No. PZ -81- 5B1B

Object: Bones

Material: Bone

Square: N W Trench
Batt. 15
Yellow Br.

Photograph:

Level:

Drawing:

Dimensions: L.,

H.,

W.,

Th.,

Technique:

Condition:

Description:

TEXAS

Date: 25 June 1981

No. PE - 81 - 582B

Object: BONES

Material: Bone

Square: N W Trench
Ceramic Dep
Level 1, Batt. 3.
Level:

Photograph:

Drawing:

Dimensions: L.,

H.,

W.,

Th.,

Technique:

Condition:

Description:

TEXAS

Date: 24 June 1981

No. PE - 81 - 583B

Object: Bones

Material: Bone

Square: NW Trench
Ceramic Dep.

Photograph:

Level: level I

Drawing:

Dimensions: L.,

H.,

W.,

Th.,

Technique:

Condition:

Description:

TEXAS

Date: 2nd July 81

No. PZ-81-584P

Object: red figure fragment

Material: ceramic

Square: Wellhead,
M¹-7 Butt 1.

Photograph:

Level: dark gray sand

Drawing:

Dimensions: L.,

H.,

W.,

Th., 0.6mm.

Technique:

Condition: good.

Description:

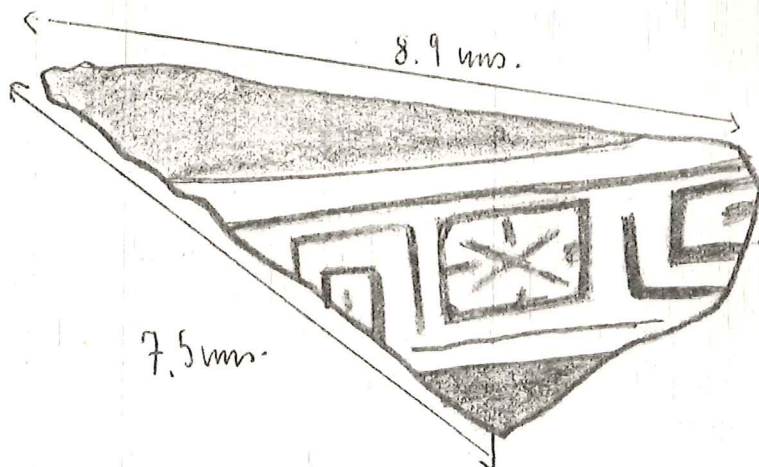

Clay colour: of fabric, Munsell 5YR 7/6 reddish yellow

of pattern, Munsell 5YR 7/4 pink.

Fragment of red-figure vase, probably not an
embedded shape, since glazed, inside as well as out.
Only the border pattern remains, alternate meander
and saltire squares. South Italian (?)
Compare the Piskini Painter.

TEXAS

Date: 24 June 1991

No. PE - 81 - 505 M

Object: Slag Chunk

Material: Metal

Square: NW Trench

Photograph:

Batt. 13

Level: Yellow Br. to
Ceramics

Drawing:

Dimensions: L.,

H.,

W.,

Th.,

Technique:

Condition:

Description:

TEXAS

Date: 24 June 1981

No. PE -81-586M

Object: Nail Frag. ? or Slag.

Material: IRON

Square: N W Trench
Batt. 15' to Dep.

Photograph:

Level:

Drawing:

Dimensions: L.,

H.,

W.,

Th.,

Technique:

Condition:

Description:

TEXAS

Date: 18 June 1981

No. PZ-81-587M

Object: Metal Slag.

Material: Slag.

Square: NW Trench
Bat. 4

Photograph:

Level:

Drawing:

Dimensions: L.,

H.,

W.,

Th.,

Technique:

Condition:

Description:

TEXAS

Date: 23 June 1981

No. PE-81-588B

Object: Bones

Material: Bone

Square: NW Trench

Photograph:

Bath. 10
N. side to tile Fall
Level:

Drawing:

Dimensions: L.,

H.,

W.,

Th.,

Technique:

Condition:

Description:

TEXAS

Date: 25 June 1981

No. P2-81-509M

Object: Piece of slag or nail frag.

Material: IRON

Square: NW Trench

Photograph:

Batt. 3 level 3

Level: Ceramic Dep.

Drawing:

Dimensions: L.,

H.,

W.,

Th.,

Technique:

Condition: very corroded.

Description:

TEXAS

Date: 25th June 81

No. PZ-81-590P

Object: coarse-ware amphora neck frag

Material: ceramic

Square: NW trench,
ceramic deposit, batt 3,
Level 4.

Photograph:

Drawing:

Dimensions: L.,

H.,

W.,

Th., 0.55mm.

Technique:

Condition: fragmentary but good

Description:

(from PZ-81-523PL)

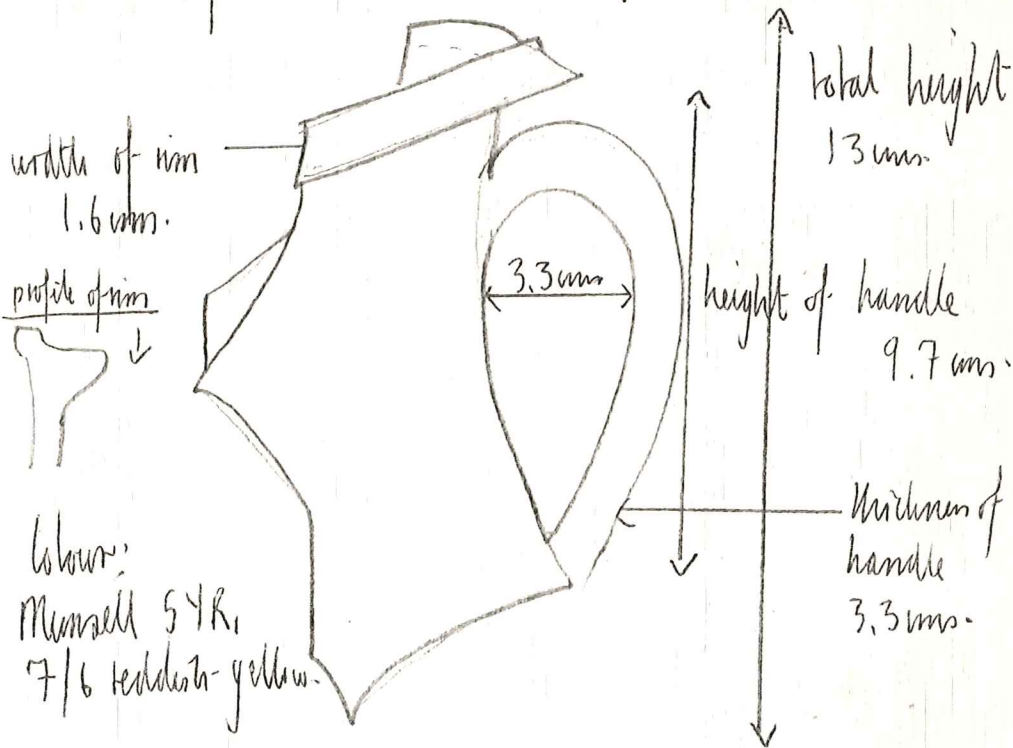

Colour:
Munsell 5YR,
7/6 reddish-yellow.

Fragment of neck, shoulder and one handle of
large coarse ware vessel, probably an amphora.
The rim is flat with a low ridge on the inside.

TEXAS

Date: 24 June 1981

No. PZ - 81 - 591m

Object: Slag

Material: Metal

Square: NW Trench
Ramp

Photograph:

Level:

Drawing:

Dimensions: L.,

H.,

W.,

Th.,

Technique:

Condition:

Description:

TEXAS

Date: 24 June 1981

No. PZ-81-592 M

Object: Nail

Material: Iron

Square: NW Trench

Photograph:

Cleaning level I

Level: to Dep.

Drawing:

Dimensions: L., max. preserved. H.,

W.,

Th.,

Technique:

7.2cm.

Condition: Heavily encrusted, badly corroded

Description:

No head preserved.

diam. at head end - a pebble is stuck
on it, along w/ encrustation: - 1.5cm.

diam. at opposite end: 0.4cm.

TEXAS

Date: 22 June 1981

No. PZ 81-593.M

Object: Nail frag. or slag?

Material: Iron

Square: NW 1/4 Sec 11
Bett. 13
yellow brown to

Photograph:

Level: Ceramic

Drawing:

Dimensions: L., 4.4cm.

H.,

W.,

Th.,

Technique: max preserved

Condition:

Description:

Max. Dimensions at ends: 0.9cm. x 0.5cm.

TEXAS

Date: 18th June 81

No. PZ-81-594T

Object: circular loom weight

Material: terracotta

Square: NW trench
Batt 4, west
Level: end

Photograph:

Drawing:

Dimensions: L.,

H.,

W.,

Th., 2.15mm

Technique:

Condition: chipped and eroded, but otherwise good.

Description:

(from PZ-81-448PL).

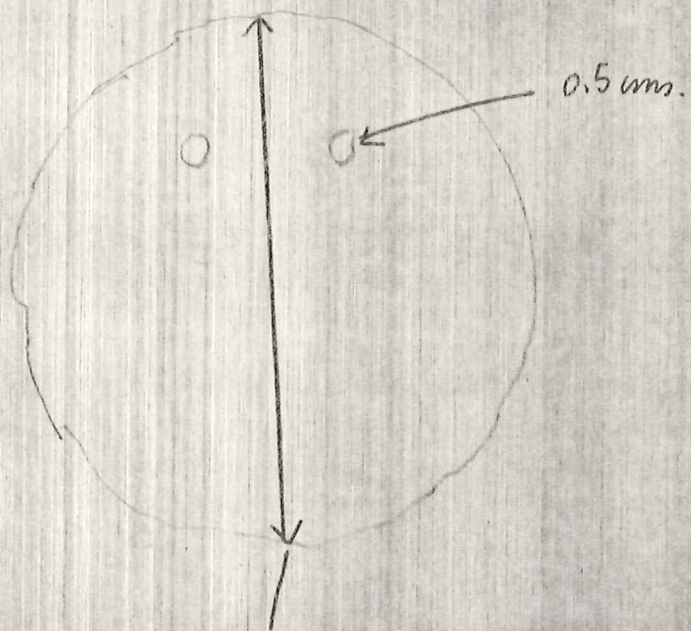

diameter 7.1 mm.

Colour: near Munsell 5YR 8/4 pink

TEXAS

Date: 24th June 81

No. PZ-81-595T

Object: fragment of circular loom weight Material: terracotta

Square: NW branch
cleaning level 1 to

Photograph:

Level: deposit

Drawing:

Dimensions: L.,

H.,

W.,

Th., 1.8 cms.

Technique:

Condition: fragmentary but good

Description: (from PZ-81-515PL)

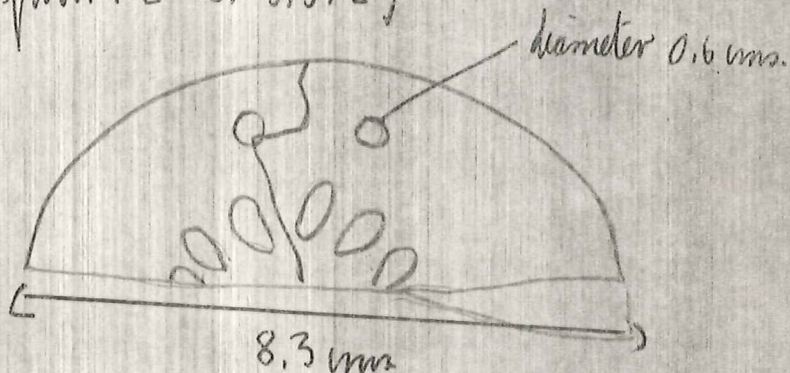

Colour: near Munsell 5YR 8/4 pinkish

Half a loom weight (in two pieces) with stamped decoration (leaf design?). The sides are more carefully worked than usual.

TEXAS

Date: 22 June 1981

No. PZ-81-596M

Object: Metal Frag - Flat Buckle? Material: Iron

Square: N W Trench

Photograph:

Butt. 6 Red-

Level: Brown

Drawing:

Dimensions: L.,

H.,

W.,

Th.,

Technique:

Condition: Badly Corroded

Description:

The piece of iron has one protuberance on one side. That the protuberance: 1.6 cm. Th. at corner. 0.8 cm.

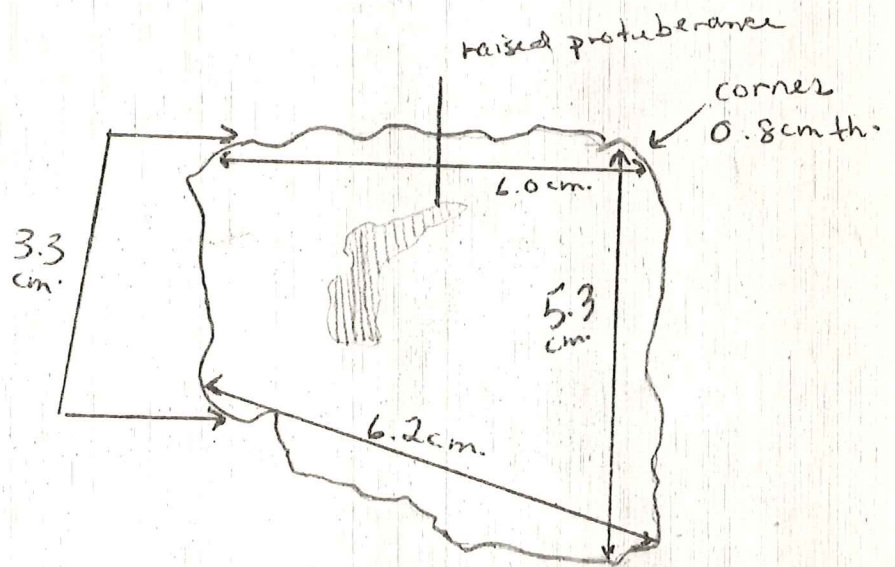

TEXAS

Date: 25th June 81

No. PZ-81-597T

Object: fragment of circular loom weight Material: terracotta

Square: NW trench,
ramp

Photograph:

Level:

Drawing:

Dimensions: L.,

H.,

W.,

Th. 0.8 cm

Technique:

Condition: fragmentary but good.

Description:

(from PZ-81-533 PL)

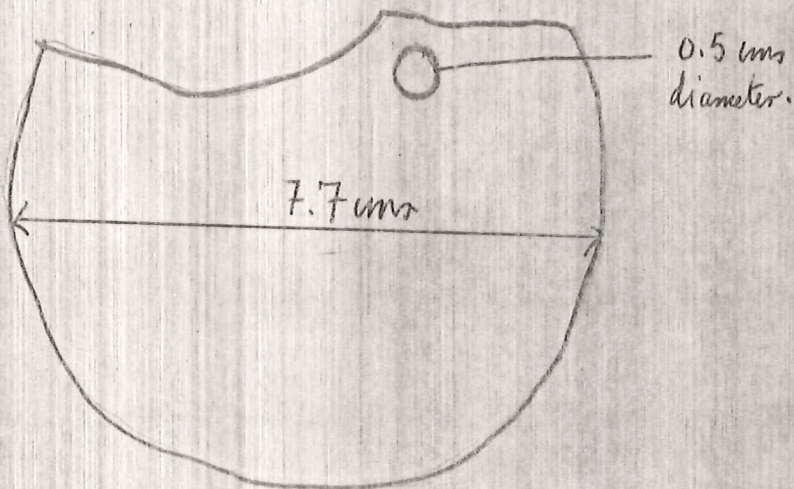

Colour: near Munsell 5YR 7/6 reddish yellow.

TEXAS

Date: JUNE 15 198

No. P2-81-548B

Object: Bone

Material: Bone

Square: J'-1 Ant. 160

Photograph:

Mid. to u. half

Gr. Br. to virgin

Level:

Drawing:

Dimensions: L.,

H.,

W.,

Th.,

Technique:

Condition:

Description:

TEXAS

Date: 24 June 1981

No. R2-81-599M

Object: Round disc of corroded iron w/ ^{inclusions} Material: Iron + Ceramic

Square: ~~was~~ Trench
Batt. 15 to deposit

Photograph:

Level:

Drawing:

Dimensions: L.,

H.,

W.,

Th., in ctr.

Technique:

1.2 cm.

Condition:

very corroded.

of potsherd
0.5 cm.

Description:

Could be head of nail w/ pot sherd inclusion + encrustation. One side has a circular (roughly) depression in the center. Potsherd has orange glaze on it.

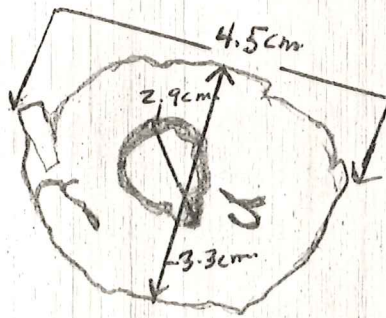

TEXAS

Date: 25th June 81

No. PZ-81-600P

Object: red figure fragment

Material: terracotta

Square: NW trench,
terracotta deposit, butt 2,
Level: level 3.

Photograph:

Drawing:

Dimensions: L., H., W., Th., 0.35 mm.

Technique: red-figure

Condition: good

Description:

Colour: fabric: Munsell
5YR, 7/4 pink

figure decoration:
Munsell 5YR, 7/6
reddish-yellow.

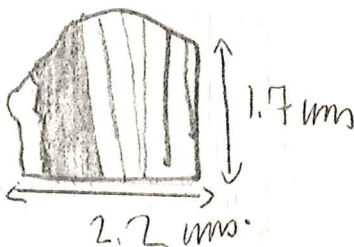

Fragment of red-figure vase, probably a closed shape, since the interior is not glazed. The reserved area is crossed by black lines of varying thicknesses, which may represent lines of drapery, perhaps covering the legs of a standing figure. The reserved areas show traces of added red: this, and the pale colour of the clay, suggest the fragment is of south Italian rather than Attic manufacture.

TEXAS

Date: 19 June 1981

No. PZ-81-601 M

Object: 4 pieces of flake + slag Material: Iron

Square: NW Trench
Batt. 5 E. to Ctr.

Photograph:

Level: Yellow 5A

Drawing:

Dimensions: L.,

H.,

W.,

Th.,

Technique:

Condition: Badly corroded

Description:

TEXAS

Date: 15th June 81

No. PZ-81-602P

Object: part of wave-wave shainer

Material: ceramic

Square: J-1 Batt 15.8
file + wave orientation

Photograph:

Level:

Drawing:

Dimensions: L.,

H.,

W.,

Th.,

Technique: wave

Condition: fragmentary, but good.

Description:

(from PZ-81-419PL)

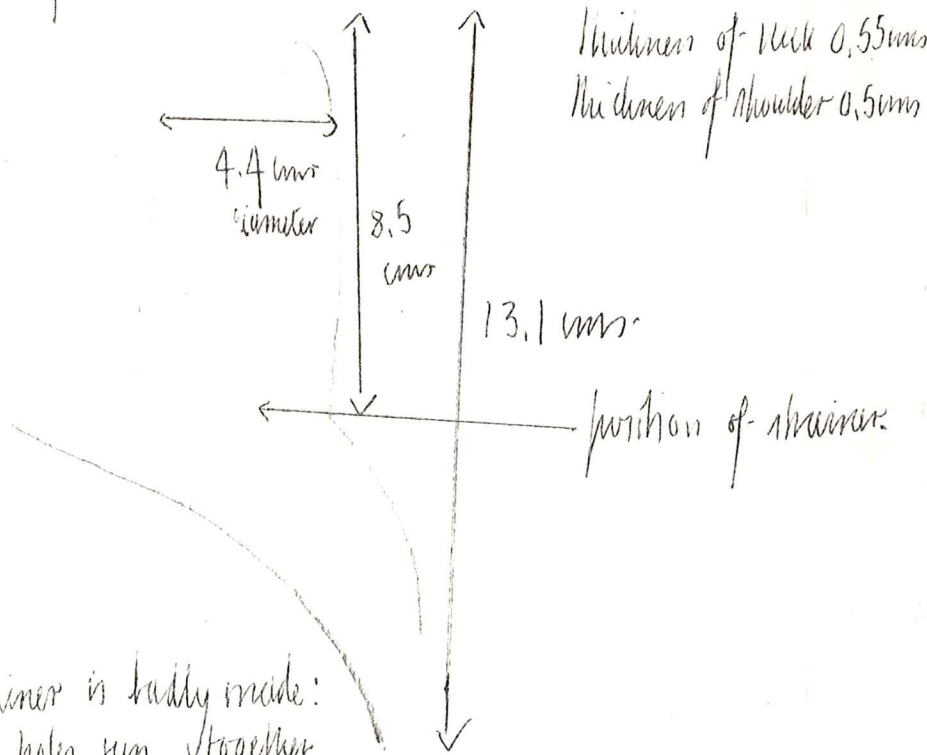

The shainer is badly made:
 only two holes, run together,
 are open, while the rest have fused shut together.
 There are a few traces of a pattern added in red
 glaze on the shoulder.

Colour of clay: - Mansell 7.5 YR, 7/8 reddish yellow

TEXAS

Date:

No. PZ-81-603P

Object:

Material:

Square:

Photograph:

Level:

Drawing:

Dimensions: L.,

H.,

W.,

Th.,

Technique:

Condition:

Description:

TEXAS

Date:

No.

PZ-81-604P

Object:

Material:

Square:

Photograph:

Level:

Drawing:

Dimensions: L.,

H.,

W.,

Th.,

Technique:

Condition:

Description:

TEXAS

Date: 25 June 1981

No.

PE-81-605P

Object: misfired molded gray ware (?)
body sherd

Material: Ceramic

Square: NWTrench,
Ceramic Deposit,
Level 3, Box 2
Level:

Photograph:

Drawing:

Dimensions: L., 4.6 cm

H., 5.7 cm

W.,

Th., 0.4 cm

Technique:

Condition: Somewhat weathered

Description: misfired molded gray ware (?) body sherd w/ three registers. The first is undecorated. The second is a band of alternating daisies (2) and concentric circles (2) - see p2-81-567. The third preserves the top portion of a round plant leaf. The glaze, a bright reddish orange has flaked off most of the interior and exterior leaving a smooth light orange surface, Munsel 5YR 6/6 reddish yellow. The clay is fine and compact.

TEXAS

Date: 25-11-81

No. PZ-81-606B

Object: Bones

Material: Bone

Square: NW French
Ceramic Dep. Batt. 3

Photograph:

Level: level 2

Drawing:

Dimensions: L.,

H.,

W.,

Th.,

Technique:

Condition:

Description:

TEXAS

Date: 18-VI-81

No. PZ-81-607 M

Object: Slag

Material: Slag

Square: NW Trench
W 1/2 Batt. 4

Photograph:

Level:

Drawing:

Dimensions: L.,

H.,

W.,

Th.,

Technique:

Condition:

Description: From PZ-81-449 PL

2 pieces of slag.

TEXAS

Date: 22-VI-81

No. PZ-81-608 M

Object: slag

Material: slag

Square: NW Trench
Batt. 6 Wend rd.
Brown to olive yellow
Level:

Photograph:

Drawing:

Dimensions: L.,

H.,

W.,

Th.,

Technique:

Condition:

Description:

From PZ-81-465 PL

TEXAS

Date: 19-VI-81

No. PZ-81-609 M

Object: Slag

Material: Slag

Square: N W Trench
Bull. 5 - Red Brown
sand E. S. of Ctr.
Level:

Photograph:

Drawing:

Dimensions: L.,

H.,

W.,

Th.,

Technique:

Condition:

Description:

2 pieces of slag

TEXAS

Date: 25-VI-81

No. PZ-81-610 B

Object: Bone

Material: Bone

Square: NW Trench
Ceramic Deposit, NW
Corner, Yellow brown
Level: to Red Brown

Photograph:

Drawing:

Dimensions: L.,

H.,

W.,

Th.,

Technique:

Condition:

Description:

TEXAS

Date: 19-VI-81

No. PZ-81-6!! M

Object: Slag

Material: Metal

Square: N W Trench
Batt 4 - W-end
Br SA w/ gravel & yellow
Level: mottled

Photograph:

Drawing:

Dimensions: L.,

H.,

W.,

Th.,

Technique:

Condition:

Description:

TEXAS

Date: 25-VI-81

No. PZ-81-512 M

Object: Slag

Material: Metal

Square: NW Trench
Ceramic Deposit
Level: 1 Bath. 2
Level:

Photograph:

Drawing:

Dimensions: L.,

H.,

W.,

Th.,

Technique:

Condition:

Description:

1 long piece of slag

TEXAS

Date: 12th June 81

No. PZ-81-613T

Object: ~~W. ext~~ tile fragment

Material: Lemnatta

Square: ~~to trench, J^W 1, 1.~~
Batt 15B, west ceramic

Photograph:

Level: deposit

Drawing:

Dimensions: L.,

H.,

W.,

Th., 3.1 mm

Technique:

Condition: good

Description:

(from PZ-81-414 PL)

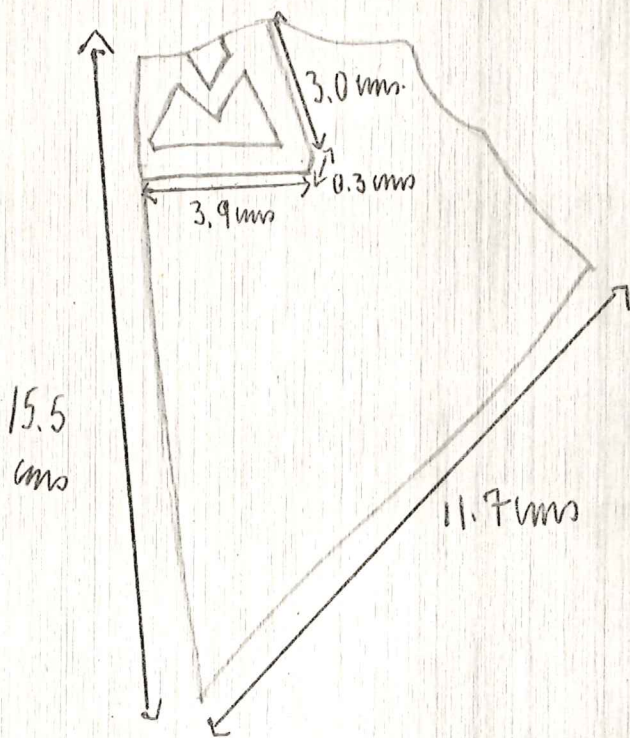

Colour: - outside,
 Russell 10YR 8/3,
 very pale brown
 - inside
 has stripe of 5YR, 7/6,
 reddish yellow.

Fragment of tile with stamped decoration in
 one corner. The stamp is not completely preserved.
 it might be the start of an inscription, with the
 letter Σ , or it might be just a decorative pattern.
 N.B. Parascene for this in "Metaphors" NSC 1960 or 1940!

TEXAS

Date: 25th June 81

No. PZ-81-623P

Object: Long ware ware amphora neck

Material: pottery

Square: NW trench,
ceramic deposits built
Level: 31 level 1

Photograph:

Drawing:

Dimensions: L.,

H.,

W.,

Th. at rim: 1.6cms
of neck - 1.5cms.

Technique: ware

Condition: fragments missing from rim and neck, otherwise good.

Description:

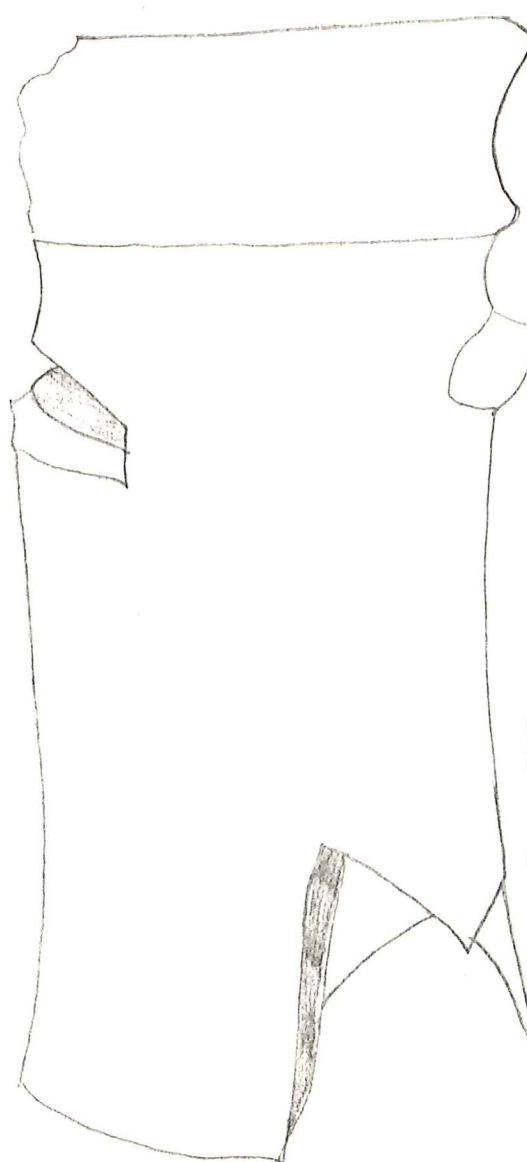

↑
height of rim: 3.9cms
inner diameter of rim: 13.4cms
↓
estimated outer diameter of rim -
c. 16.5cms

max. extant height: 31cms.

clay colour: - core -
Midsell 5YR 7/6 reddish yellow
outside: " 7.5YR 7/6 " "

This amphora had a huge, elongated and thick neck. The handles, judging from the huge handle attachment, must have been extremely large. The fabric is coarse and very thick - the rim is coarse & deep.

TEXAS

Date:

25 June 1981

No.

PZ-81-626B

Object:

Bones

Material:

Bone

Square: NW TRENCH

Photograph:

CERAMIC DEP

Level: BATT. 3 Level 1

Drawing:

Dimensions: L.,

H.,

W.,

Th.,

Technique:

Condition:

Description:

TEXAS

Date: 1st July 81

No. PZ-81-627P

Object: Small black-glazed vessel

Material: Ceramics

Square: Well Trench
B. 2, M. 6, O. 9

Photograph:

Level:

Drawing:

Dimensions: L., H., W., Th., 0.2 cms

Technique: black glaze with added decoration in white paint(?)

Condition: fragmentary, glaze dull, otherwise good.

Description:

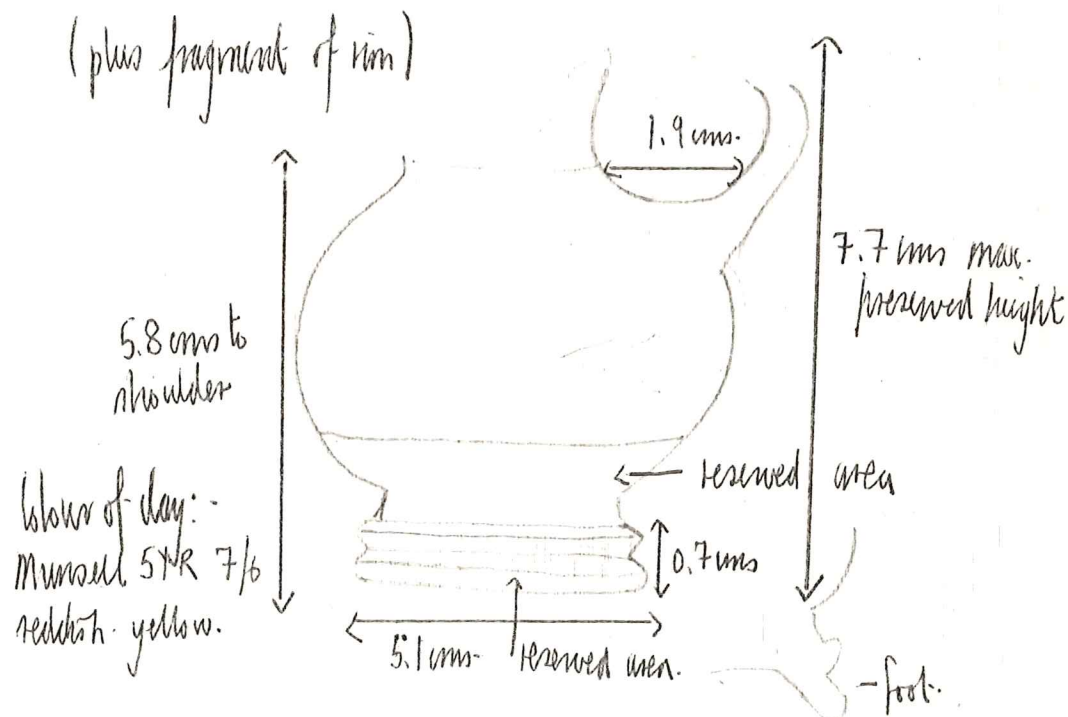

Small black glazed vessel, some type of ovoid. The glaze extends unevenly down the neck inside. Part of the foot and the lower part of the body are reserved. The vessel has a plump, squat body and a wide neck. The handle has a deep central incision. The foot is high and elaborately moulded. Traces of pattern decoration can be observed; around the shoulder are rays, and around the widest part of the body an olive leaf-chelon. These were probably executed in white paint.

TEXAS

Date: 25 June 1981

No. PZ-81-C30P A+B

Object: 2 shallow gray ware bowls Material: Pottery

Square: NW Trench

Photograph:

Ceramic Dep.
Bull. 3 Level 1
Level:

Drawing:

Dimensions: L.,

H.,

W.,

Th.,

Technique:

A 4.8 cm

Diameter 8.2 cm

0.4 (rim) to 0.6 (body)

B 4.7 cm

Diameter ~9.0 cm

0.3 (rim) to 0.55 (body)

Condition: Fragmentary, approximately 2/3 of each vessel is preserved

Description:

(From PZ-81-621 PL)

Shallow gray ware bowls w/ hanging vertical sides and small ring feet.

A. The interior glaze is a light black. Some of the glaze on the interior has worn away leaving a light gray spiral following the circles of the potter's wheel. The vertical section of the vessel has traces of black glaze.

B. Both the exterior & interior are an olive/gray. Much of the glaze is flaking off. There is a trace of black glaze beneath the vertical side.

The feet and the under sides of the vertical walls of both vessels are different. The foot of B is taller than A.

TEXAS

Date: 25 June 1981

No. PE-81-631P

Object: Gray Ware - ³/₄ Base of a closed vessel Material: Ceramic

Square: NW Trench

Photograph:

Ceramic Dep

Level: Batt. 3 level 1

Drawing:

Dimensions: L.,

H.,

W.,

Th.,

Technique:

Condition:

Description:

(from PE-81-621PL)

TEXAS

Date: 2nd July 81

No. PZ-81-641P

Object: small skyphoid vessel

Material: Ceramic

Square: Well Trench
Boil Spring sect. 2

Photograph:

Level:

Drawing:

Dimensions: L.,

H.,

W.,

Th., 0.1 cm.

Technique:

at rim

Condition: slightly chipped at rim, glaze worn, otherwise good.

Description: (exact find spot in M-6 was 1.0m east x 2.0m north, by lone conglomerate block).

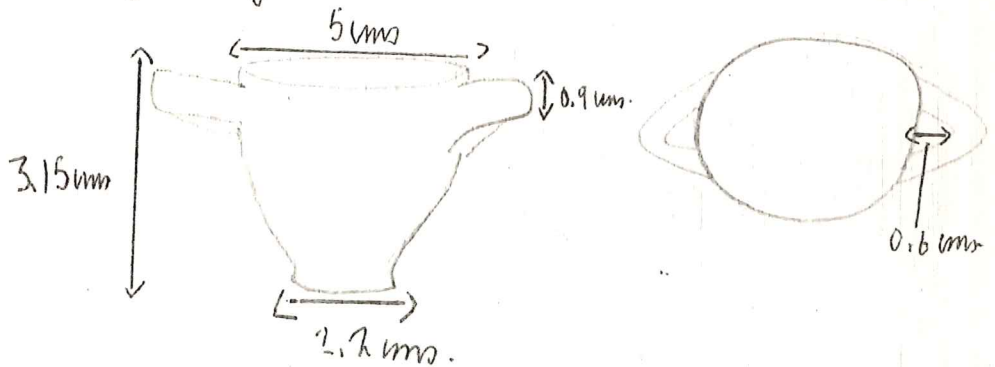

Clay colour: Munsell 5R 7/4 pink.

The small, wide skyphoid-shaped vessel has thick round handles and curves sharply to the base. Traces of washed black glaze are preserved in a stripe just inside the rim, and on the upper surface of the handles. Votive vessel?

TEXAS

Date: 1st July 81

No. PE-81-642P

Object: Small clay/stoneware vessel

Material: ceramic

Square: Well bench,
spring ret. 2.

Photograph:

Level:

Drawing:

Dimensions: L.,

H.,

W.,

Th., 0.25mm
at rim.

Technique:

Condition: mounted but quite good.

Description:

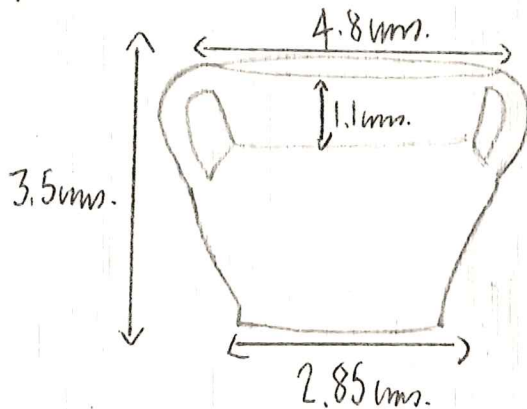

Urg colour:
Munsell 7.5YR 7/6
reddish yellow.

This vessel has an offset lip and vertical handles, one of which is slightly longer than the other. It is extremely wide in shape, and irregularly made. Possibly a water vessel?

TEXAS

Date:

16 June 1981

No. ~~111~~

PZ -81-643B

Object:

Bones

Material:

Bone

Square:

N W Trench

Photograph:

Batt. 2

Level:

Drawing:

Dimensions: L.,

H.,

W.,

Th.,

Technique:

Condition:

Description:

TEXAS

Date: 17 June 1981

No. 72-81-644B

Object: Bones

Material: Bones

Square: NW Trench

Photograph:

Level: Butt. 2
exc. the fall

Drawing:

Dimensions: L.,

H.,

W.,

Th.,

Technique:

Condition:

Description:

TEXAS

Date:

16 June 1981

No.

PZ - 81 - 645M

Object: Slag

Material: Slag. Iron

Square: N W TRENCH

Photograph:

BATT 2

Level:

Drawing:

Dimensions: L.,

H.,

W.,

Th.,

Technique:

Condition:

Description:

TEXAS

Date: 16 June 1981

No. PE-81-46M

Object: chunk of slag or nail head + nail shaft
Material: Iron

Square: No trench

Photograph:

Butt. 1 Cleaning

Level: Level

Drawing:

Dimensions: L.,

H.,

W.,

Th.,

Technique:

Condition: Fragmentary and corroded.

Description:

One globular and one straight piece of iron.

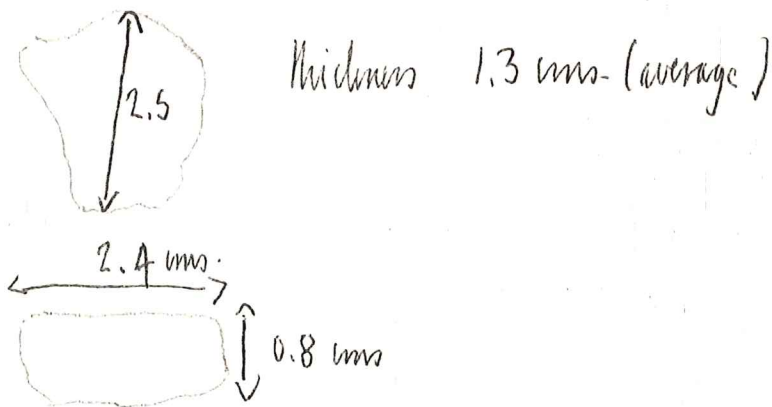

These would be the head and part of the shaft of a nail (or two nails).

TEXAS

Date: 17 June 1981

No. PZ-81-647B

Object: Bones

Material: Bone

Square: NW Trench

Photograph:

Batt. 2

Level: T. 6 Fall + Under

Drawing:

Dimensions: L.,

H.,

W.,

Th.,

Technique:

Condition:

Description:

TEXAS

Date: 17 June 1981

No. PZ-81-648M

Object: Metal Slag

Material: SLAG - metal

Square: NW TRNCH
Butt. 2 In front
Level: of the fall.

Photograph:

Drawing:

Dimensions: L.,

H.,

W.,

Th.,

Technique:

Condition:

Description:

TEXAS

Date: 17 June 1981

No. PZ-81-649T

Object: 1 frag. of votive plaque

Material: Terracotta

Square: NW Trench

Photograph:

Box 2
exc. tile fall.

Level:

Drawing:

Dimensions: L.,

H.,

W.,

Th., average
0.6mm

Technique:

Condition:

Description:

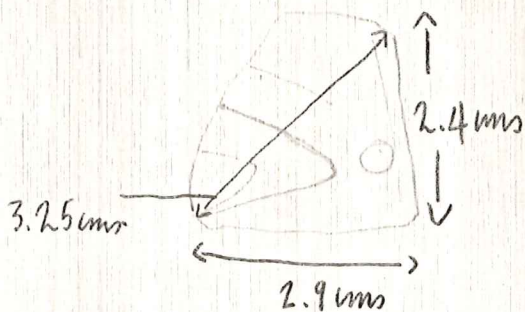

Fragment of terra-
cotta plaque with
one finished edge.
Impossible to see
what was represented
on the plaque.

Mumukh 7.57R 8/6 reddish yellow.

TEXAS

Date: 17 June 1981

No. PE-81-650M

Object: Bronze nail?

Material: Bronze?

Square: New Trench
Fall . 2

Photograph:

Level: T. La Fall + Under

Drawing:

Dimensions: L.,

H.,

W.,

Th.,

Technique:

Condition: ^{good.} corroded, and with greenish deposits and encrustations - otherwise

Description:

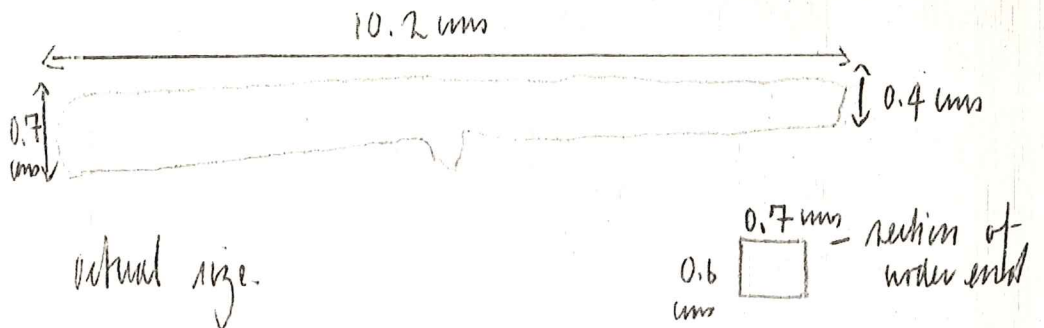

The nail is square in section, and has a projecting spike about half way along its preserved length. The pointed edge is broken.

TEXAS

Date: 15th June 81

No. PZ-81-651P

Object: Unguentarium - black glazed. Material: Ceramic

Square: 51-1 Batt. (D)
Ceramic concentration

Photograph:

Level:

Drawing:

Dimensions: L., H., W., of rim. Th.,
0.5cm.

Technique: Diam. of base - 2.5cm.

Condition: Inner diam. of mouth: 1.2cm; outer diam. 2.3cm.

Description: (Crack find spot - 1.0m N from edge).

This vessel has one break, near the base of the neck. It is scratched and the glaze is worn slightly, but is in good condition.

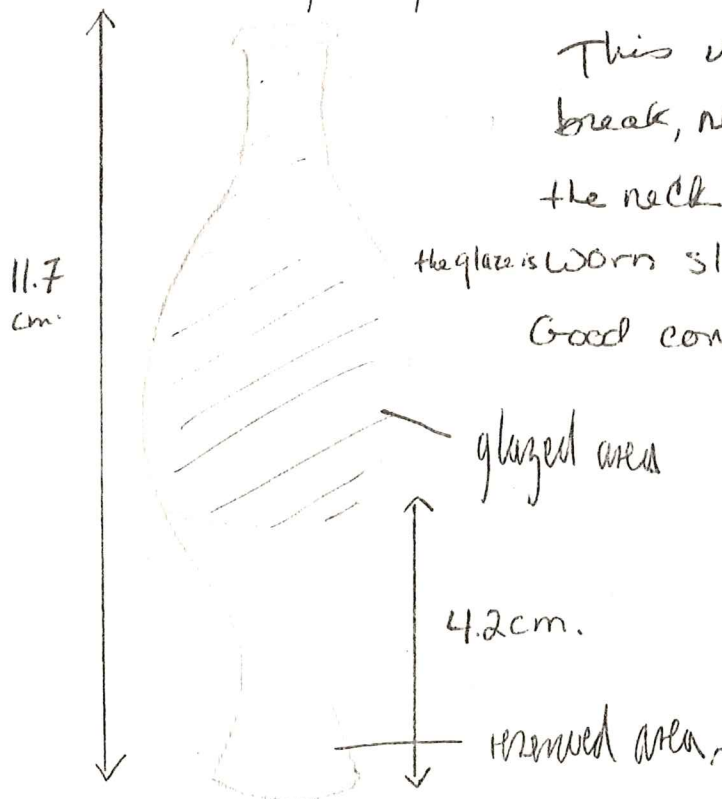

TEXAS

Date: 17 June 1981

No. PZ - 81 - 652M

Object: Bronze Flake

Material: BRONZE

Square: NW Trench

Photograph:

Batt. 3

Level: W. End
Pr. St w/ gravel

Drawing:

Dimensions: L.,

H.,

W.,

Th.,

Technique:

Condition: fragmenting and encrusted

Description:

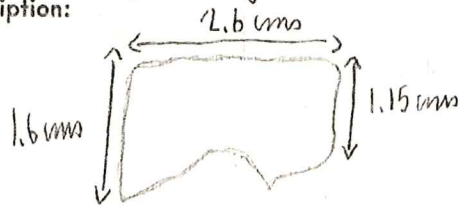

(actual size).

Thickness 0.1 mm

Small piece of flattened, thin, sheet bronze. The straight edges may be finished, but it is hard to be sure! The flake could come from a fibula or other piece of jewelry.

TEXAS

Date: 17 June 1981 No. PZ-81-6535

Object: Lithic Material: Chert

Square: NW trench Photograph:

Batt. 2
In front of tile
Level: Fall.

Drawing:

Dimensions: L., H., W., Th.,

Technique:

Condition: good

Description:

This flake measures approximately 1.35 x 1.1 cm and is c. 0.2 cm thick.

It is dark brown in colour and has several faces.

TEXAS

Date: 18 June 1981

No. PE-81-654M

Object: Slag

Material: Metal

Square: NWTrench
Batt. 3

Photograph:

Level: $\frac{1}{2}$ SA w/ gauge

Drawing:

Dimensions: L.,

H.,

W.,

Th.,

Technique:

Condition:

Description:

TEXAS

Date: 18 June 1981

No. PZ -81 - 655Bs

Object: 1 shell - marine

Material: Shell -

Square: NW trench

Photograph:

Box: 3 N. 1/2

Level: Red Brown
5.1

Drawing:

Dimensions: L.,

H.,

W.,

Th.,

Technique:

Condition:

Description:

TEXAS

Date: 18 June 1981 No. PE-81-656 P

Object: Terra Sig. Bowl Rim Material: Ceramic

Square: N W TRENCH

Photograph:

Batt. 3 N. 1/2

Level: Lt. Yellow soil

Drawing:

Dimensions: L.,	H.,	W.,	Th.,
			at rim 0.3 mm
			average 0.5 mm

Technique:

Condition: some encrustation, but good

Description:

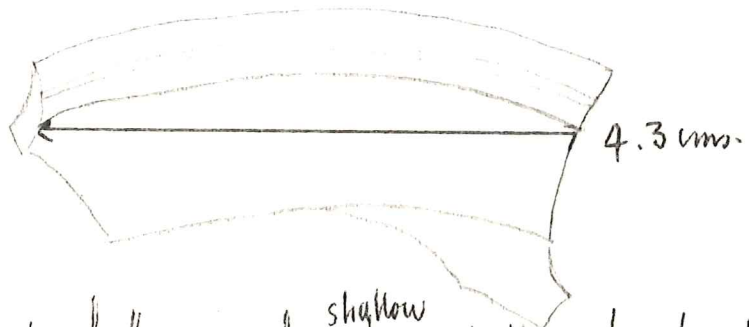
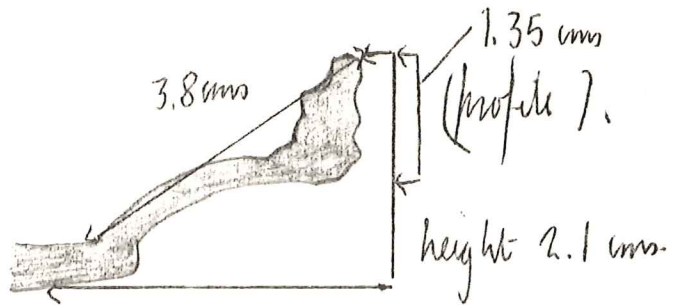

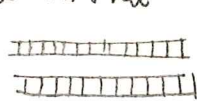
Fragment of the rim of a ^{shallow} terra sigillata bowl or plate, finely worked and decorated on the outside with three rows of tooth pattern (), two on the rim, and one to articulate the division of the rim from the base. The rim is finely beveled, and the quality of the glaze is excellent and deep red in colour.

TEXAS

Date: 18 June 1981

No. PZ-81-657B

Object: Bones

Material: Bone

Square: NW TRENCH

Photograph:

Batt. 3 - S. 1/2

Br. SA w/ gravel

Level:

Drawing:

Dimensions: L.,

H.,

W.,

Th.,

Technique:

Condition:

Description:

TEXAS

Date: 18 June 1981

No. PZ-81-658B

Object: Bones

Material: Bone

Square: NW Trench
Batt. H E. end
Level: Red Brown

Photograph:

Drawing:

Dimensions: L.,

H.,

W.,

Th.,

Technique:

Condition:

Description:

TEXAS

Date: 18 June 1981

No. 77-81-658B-11

Object: Piece of worked bone inlay

Material: Bone

Square: NW TRENCH
Batt. 4 E. end

Photograph:

Level: Red Brown.

Drawing:

Dimensions: L.,

H.,

W.,

Th., 0.2 mm

Technique:

Condition:

Very good - no broken edges, little encrustation

Description:

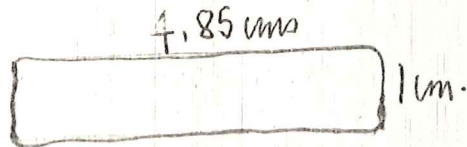

actual size.

TEXAS

Date: 26 June 1981

No. PE-81-659B

Object: Bones

Material: Bone

Square: NW Trench

Photograph:

Ceramic Dip ?

Level:

Drawing:

Dimensions: L.,

H.,

W.,

Th.,

Technique:

Condition:

Description:

TEXAS

Date: 26 June 1981

No. PZ - 81 6603

Object: Bones

Material: Bone

Square: NW Trench

Photograph:

Ceramic Dep.
Batt. 6 Level 4
Level: E. side near bones

Drawing:

Dimensions: L.,

H.,

W.,

Th.,

Technique:

Condition:

Description:

TEXAS

Date: 25 June 1981

No. PZ-81-661B

Object: Bones

Material: Bone

Square: NW Trench
Ceramic Dep.

Photograph:

Level: Batt. 3 level 1

Drawing:

Dimensions: L.,

H.,

W.,

Th.,

Technique:

Condition:

Description:

TEXAS

Date: 18 June 1981

No. PZ - 81-662T

Object: Terraco Ha Frag.

Material: Terracotta

Square: NW Trench
Batt. 3 5. 1/2
Level: Br. SA w/ gravel

Photograph:

Drawing:

Dimensions: L.,

H.,

W.,

Th.,

Technique:

Condition: eroded but good

Description:

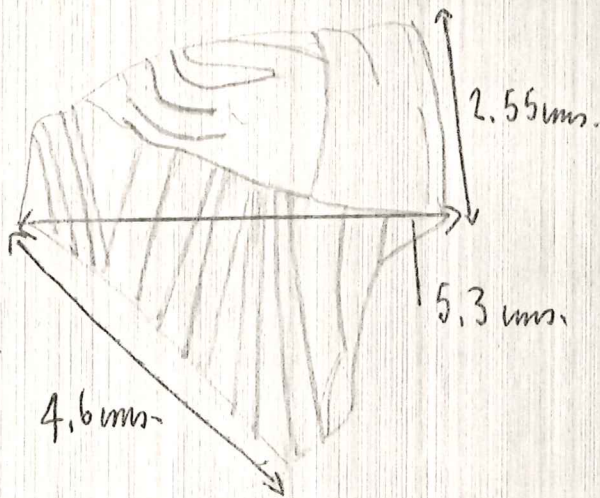

Fragment of relief plaque, showing the waist, hand and part of the drapery of a figure. The workmanship is fine, the hand in particular being finely shown. The drapery folds are deep and create a 3-dimensional effect.

Clay colour: - near Munsell 7.5YR, 7/6 reddish yellow.

TEXAS

Date: 18 June 1981

No. PZ -81-663B

Object: Bones

Material: Bone

Square: NW TRENCH
BATT. 3[?] N. 1/2

Photograph:

Level: Red-Brown Soil

Drawing:

Dimensions: L.,

H.,

W.,

Th.,

Technique:

Condition:

Description:

TEXAS

Date: 18 June 1981

No. PZ-81- 664B

Object: Bones

Material: Bone

Square: NW Trench

Photograph:

Batt. 3 W. 1/2

Level: yellow SA +
Reddish SA

Drawing:

Dimensions: L., w. to ctr

H.,

W.,

Th.,

Technique:

Condition:

Description:

TEXAS

Date: 18 June 1981

No. PZ-81-665S

Object: *bullet*

Material: *Chest*

Square: *NW Trench*
Batt. 4 Br. St

Photograph:

Level: *w/ gravel.*

Drawing:

Dimensions: L.,

H.,

W.,

Th., *0.5cm.*
(max.)

Technique:

Condition:

Description:

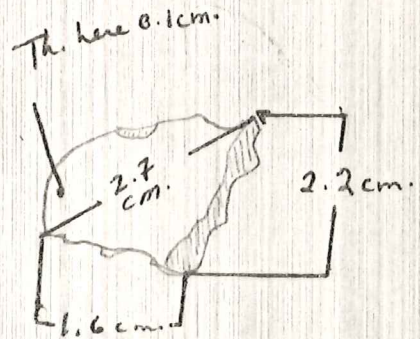

TEXAS

Date: 14 June 1981

No. PZ-81-66M

Object: Bronze Chip

Material: Bronze

Square: NW Trench
Bat. 4 W. end
Level: Mottled Yellow/br.

Photograph:

Drawing:

Dimensions: L.,

H.,

W.,

Th.,

Technique:

Condition:

Description:

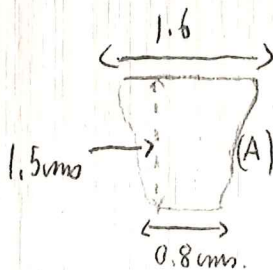

Thickness 0.19 mm average.

Very thin flake or chip of sheet bronze,
slightly curved.

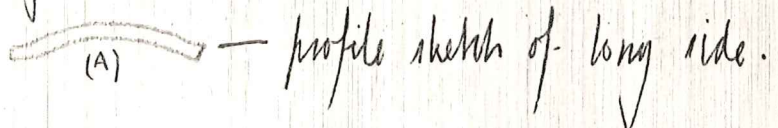

TEXAS

Date: 18 June 1981

No. PE-81-667B

Object: BONES

Material: Bone

Square: N W TRENCH

Photograph:

Batt. 4
Level: Br. Saw / gravel.

Drawing:

Dimensions: L.,

H.,

W.,

Th.,

Technique:

Condition:

Description:

TEXAS

Date: 18 June 1981

No. PZ-81-668B

Object: Bones

Material: Bone

Square: NW Trench
Batt. 3 N1/2
Lt. Yellow soil
Level:

Photograph:

Drawing:

Dimensions: L.,

H.,

W.,

Th.,

Technique:

Condition:

Description:

TEXAS

Date: 18 June 1981

No. PZ-81-669m

Object: Iron fragments

Material: Iron

Square: NW Trench
Box: 4
Yellow w/gravel
Level: E. End

Photograph:

Drawing:

Dimensions: L.,

H.,

W.,

Th.,

Technique:

Condition: Fragmentary and encrusted.

Description:

Three fragments of iron, one perhaps a nail: -

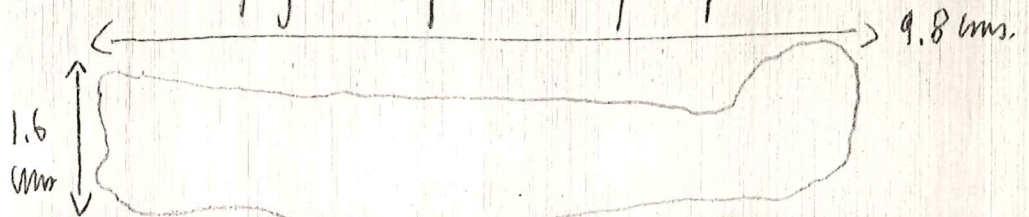

(actual size).

average thickness 0.6 cm.

The nail is flattened out at one end.

The other two fragments are shorter, one 5.8 and the other 4.2 cm long.